



CONSTRUCTION INSPECTOR'S COURSE MANUAL

SOILS COMPACTION

AND TESTING

2024-2025



**TECHNICAL TRAINING AND
CERTIFICATION PROGRAM**

TECHNICAL TRAINING AND CERTIFICATION PROGRAM

CONTACT INFORMATION

CONTACT PERSON	ADDRESS	PHONE #
Brian Squier - TTCP Coordinator brian.squier@iowadot.us	Technical Training & Certification Program and District 1 Materials 800 Lincoln Way Ames, Iowa 50010	515-233-7915
Hope Arthur - TTCP Coordinator hope.arthur@iowadot.us		515-509-8302
Jon Kleven jon.kleven@iowadot.us	District 2 Materials 428 43rd Street SW Mason City, Iowa 50401	641-422-9428
Alex Crosgrove alex.crosgrove@iowadot.us	District 3 Materials 6409 Gordon Drive Sioux City, Iowa 51106	712-239-4713
Mike Magers michael.magers@iowadot.us	District 4 Materials 2310 E. Seventh St. Atlantic, Iowa 50022	712-243-7649
Helen Bailey helen.bailey@iowadot.us	District 5 Materials 205 E. 227th St. Fairfield, Iowa 52556	319-759-5408
Tammy Siebert tammy.siebert@iowadot.us	District 6 Materials 5455 Kirkwood Blvd. SW Cedar Rapids, Iowa 52404	319-364-0235

Des Moines Area Community College (DMACC)

Boone Campus
1125 Hancock Drive
Boone, Iowa 50036

Kelli Bennett
Phone number: 515-433-5232
Email: kabennett@dmacc.edu

or

Renee White
Phone number: 515-433-5056
Email: crwhite@dmacc.edu

ORGANIZATIONS CONTACT INFORMATION

Des Moines Area Community College (DMACC)

Boone Campus
1125 Hancock Drive
Boone, Iowa 50036

Kelli Bennett

Phone number: 515-433-5232

E-mail: kabennett@dmacc.edu

or

Renee White

Phone number: 515-433-5056

E-mail: crwhite@dmacc.edu

TABLE OF CONTENTS

INTRODUCTION

1.	Introduction and Course Objectives.....	1
----	---	---

EMBANKMENT CONSTRUCTION3

1.	Soils Classifications	3
a.	AASHTO Classification	3
b.	Textural Classification	8
2.	Shear Strength.....	9
3.	Iowa DOT Material Classifications and Unsuitable Placement Requirements.....	9
4.	Soil Sheets.....	10
5.	Soil Compaction.....	12
a.	Proctor Density Curve.....	12
b.	Equipment.....	14
c.	Compaction.....	14

HOW TO CALCULATE MOISTURE CONTENT 16

HOW TO DETERMINE PROCTOR DENSITY 19

1.	Proctor Density Calculations.....	21
2.	One Point Proctor	24

MOISTURE CONTROL REQUIREMENTS25

1.	Moisture Content Limits	25
2.	Testing Frequency.....	25
3.	Moisture Content Test Procedure	25

MOISTURE AND DENSITY REQUIREMENTS.....26

OTHER POTENTIAL REQUIREMENTS26

DENSITY MEASUREMENT27

APPENDIX

1.	Proctor Density Calculation Sample Solutions	33
2.	Clay & Silt Identification Information.....	35
3.	USDA Identification flowchart	41

REVIEW WORKSHEETS

1.	Soils Certification Review	45
2.	IM Worksheet.....	51

IOWA DOT INFORMATION

SPECIFICATIONS

1. Portion of Section 2102
2. Section 2107

STANDARD ROAD PLANS

1. EW-102

IM 309 - Determining Standard Proctor Moisture Density Relationship of Soils

IM 312 - Sampling of Soils for Construction Project

IM 335 - Determining Moisture Content of Soils

IM 540 - Quality Management & Acceptance – Embankment Construction

OTHER IM'S

1. IM 204 - Appendix A – Roadway & Borrow Excavation & Embankments
2. IM 208 – Materials Laboratory Qualification Program
3. IM 213 Appendix D – Soils Technician Duties
4. IM 216 – Guidelines for Determining the Acceptability of Test Results
5. IM 334 – Determining Moisture Content & Density of Soils, Bases & Sub bases with a Nuclear Gauge

DOCUMENTATION

1. Links for various forms
2. Sample E107
3. Materials 101 Form - Excavation

POWERPOINT

1. Introduction P-1
2. Soils types, classification, etc P-4
3. Standard Proctor test..... P-20
4. Compaction..... P-29
5. Soils Review P-40

FORMULAS AT A GLANCE

$$\text{Moisture content \%} = 100 \times \frac{\text{mass of water in the sample}}{\text{mass of dry soil}}$$

(nearest tenth %) (ex. 11.34 = 11.3% and 17.85 = 17.9%)

Where:

mass of water in the sample = (mass of wet soil + Pan) – (mass of dry soil + Pan)

mass of dry soil = (mass of dry soil + Pan) – (mass of Pan)

$$\text{Wet density} = (\text{Soil \& proctor mold mass} - \text{Proctor mold mass}) \times 0.06614$$

$$\text{Dry density} = \frac{\text{Wet density}}{\left[1 + \left(\frac{\text{Moisture content \%}}{100} \right) \right]}$$

One point proctor:

Find chart in Materials IM 309. Using moisture content and **wet** density, draw two straight lines. Select closest curve to intersection of the two lines. Intersection must fall within "Range of Highest Confidence". Using curve number of selected curve, in upper right find optimum moisture content and maximum dry density.

$$\% \text{ Compaction} = \frac{\text{In - place dry density}}{\text{Maximum dry density}} \times 100$$

$$\text{Req'd in-place dry density} = \text{Req'd \% compaction}/100 \times \text{Maximum dry density}$$

Density from drive cylinder:

$$\text{In - Place Wet Density} = \frac{(\text{Mass of cylinder \& wet soil} - \text{mass of cylinder})}{\text{Volume of cylinder}}$$

INTRODUCTION

Introduction & Course Objectives

Grading work is the foundation building project for the highway. This foundation is usually built only once. Hence, it is very important to build it properly. The foundation must be strong enough to assure that (1) the pavement will perform; (2) the highway can carry a certain number of traffic loads; (3) the unnecessary cost and construction delay due to failure are minimized. Just as when a person is building a dream home, he or she does not want to see a tilted floor and cracks all over the walls. It is certainly not desirable to have too many bumps and cracks on the highways. Unfortunately, the soils formation is seldom uniform. There are many different layers and kinds of soil a person would have to deal with during a grading project. One may have to ask many questions during a grading project:

- How can a person recognize what soil he or she is dealing with?
- Why do these soils have different colors but are still the same classification?
- Where should a certain soil type be used?
- Should this bad soil be right under the mainline or should it be out on the slope?
- Should a sheepsfoot roller be used to compact this sandy soil or should it be something else?
- How can a person tell if adequate compaction is achieved or overcompaction has happened?

An inspector may have many questions in regard to the earthwork. There is nothing wrong with asking questions. There is only one “stupid” question, which is the one that could not be answered because it was never asked. The intent of the training is to provide the inspector (1) a chance to ask questions; (2) a chance to learn, understand, and be ready; (3) an opportunity to make work more enjoyable. Please do not hesitate to express concerns or comments.

Primary objectives of this course are to:

- Determine moisture content of soil
- Determine moisture-density relationship of soil using Standard Proctor Test
- Describe how to read a soil plan sheet

Another goal of this course is to provide additional background information that will help you with your job.

TABLE 1 Classification of Soils and Soil-Aggregate Mixtures (with Suggested Subgroups)

General Classification	Silt-Clay Materials (More than 35% passing No. 200)									
	Granular Materials (35% or less passing No. 200)			Silt-Clay Materials						
Group Classification	A-1			A-2				A-7		
	A-1-a	A-1-b	A-3	A-2-4	A-2-5	A-2-6	A-2-7	A-4	A-5	A-6

Sieve analysis, percent passing:

No. 10	50 max.											
No. 40	30 max.	50 max.	51 min.									
No. 200	15 max.	25 max.	10 max.	35 max.	35 max.	35 max.	35 max.	36 min.	36 min.	36 min.	36 min.	36 min.

Characteristics of fraction passing No. 40:

Liquid limit				40 max.	41 min.	40 max.	41 min.	40 max.	41 min.	40 max.	41 min.	41 min.
Plasticity index	6 max.		NP	10 max.	10 max.	11 min.	11 min.	10 max.	10 max.	11 min.	11 min.	11 min.
Usual types of significant constituent materials	Stone fragments, gravel and sand	Fine sand		Silty or clayey gravel and sand			Silty soils			Clayey soils		

General rating as subgrade

Excellent to good Fair to poor

*Classification procedure: With required test data available, proceed from left to right on above chart and correct group will be found by the process of elimination. The first group from the left into which the test data will fit is the correct classification.

*Plasticity index of A-7-5 subgroup is equal to or less than LL minus 30. Plasticity index of A-7-6 subgroup is greater than LL minus 30 (see Fig. 14.1).

Embankment Construction

In order to achieve a quality embankment, it is very important to understand the soils behavior and their best uses for the project. There is a lot of preliminary work before the grading project actually starts. Soil boring and testing are the typical requirements. This section will provide some information on the soil classification, behavior, and compaction.

1. Soil Classifications

There are several systems of soil classification. In order to simplify this training, only two systems, the American Association of State Highway and Transportation Officials (AASHTO) and the U.S. Department of Agriculture (USDA) textural classifications the Iowa DOT uses will be presented.

a. AASHTO Classification

This system requires information on sieve analysis, liquid limit, and plasticity index. Before a soil can be classified, these properties must be determined first. Table 1 shows the AASHTO classifications.

Sieve Analysis: A mechanical sieve analysis is used for the sand and gravel fractions (Figure 1). A gradation is done with a hydrometer for the finer particles in which the settling velocity of the particles (spheres) in liquid is determined by distance of the hydrometer in the liquid and time. Particles with larger diameters will settle more quickly than those with smaller ones. From this settling velocity, the particle diameter is calculated and the silt and clay contents are determined. Please see Figure 2. Figure 3 shows relative sizes of gravel, sand, silt, and clay.

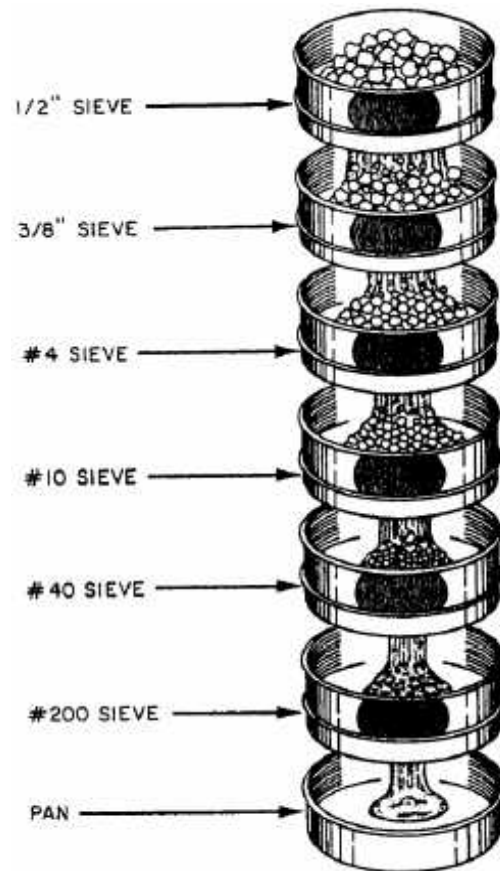

Figure 1

Liquid Limit: Liquid limit (LL) is the moisture content above which a soil readily becomes a liquid. In general, the higher the liquid limit, the more compressible the soil may be and the more volume changes may occur. To run this test a small amount (250 grams) of soil passing the Number 40 sieve is mixed with water to a paste consistency. It is then placed in a round-bottomed brass cup and the surface is struck off with a spatula so that the maximum thickness is $\frac{3}{8}$ of an inch (10 mm). The soil is next divided into two segments by means of a grooving tool. The cup is then raised and dropped onto a hard rubber block causing the divided soil to flow together. The moisture content at which it takes 25 blows to close the groove is the liquid limit. Please see Figure 4.

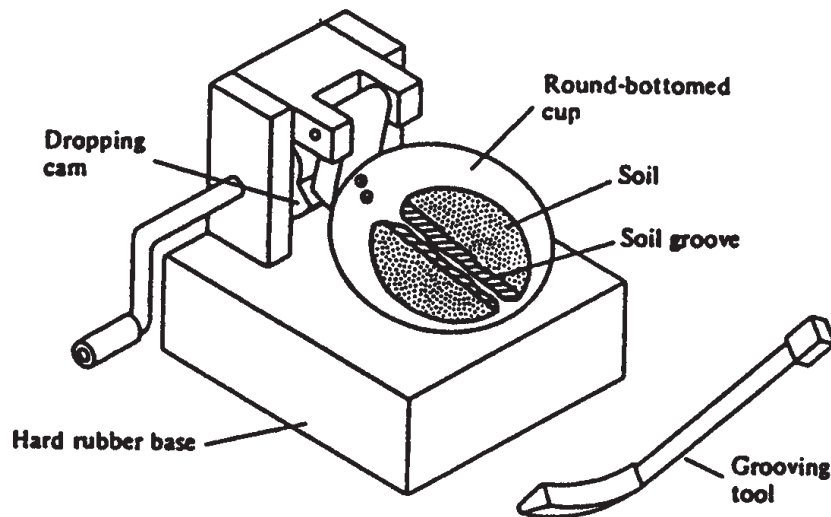
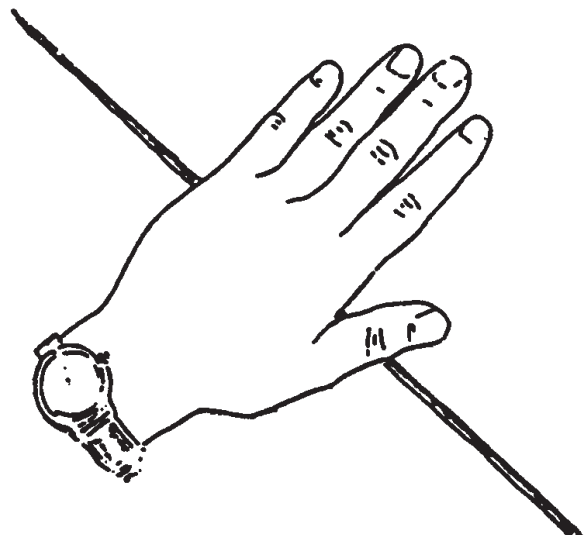

Figure 4

Plastic Limit: In order to determine the plasticity index, the plastic limit (PL) must be obtained. Plastic limit is the minimum moisture content at which the soil acts as a plastic solid. To run this test, a small soil-water mixture (soil particles passing No. 40) is rolled out with the palm of the hand on a glass plate until a thread of soil is formed. When the thread is rolled to a diameter of $\frac{1}{8}$ of an inch, it is balled up and rolled out again. The mixture gradually loses moisture in the process. Finally the sample dries out to an extent that it becomes brittle and will no longer hold together in a continuous thread. This moisture content is the plastic limit. Please see Figure 5.

Figure 5



Plasticity Index: Plasticity index (PI) is the numerical difference between the liquid limit and the plastic limit (Figure 6). The plasticity index is a measure of the cohesive property of the soil. In general, the higher the PI, the softer the soil tends to get in wet weather.

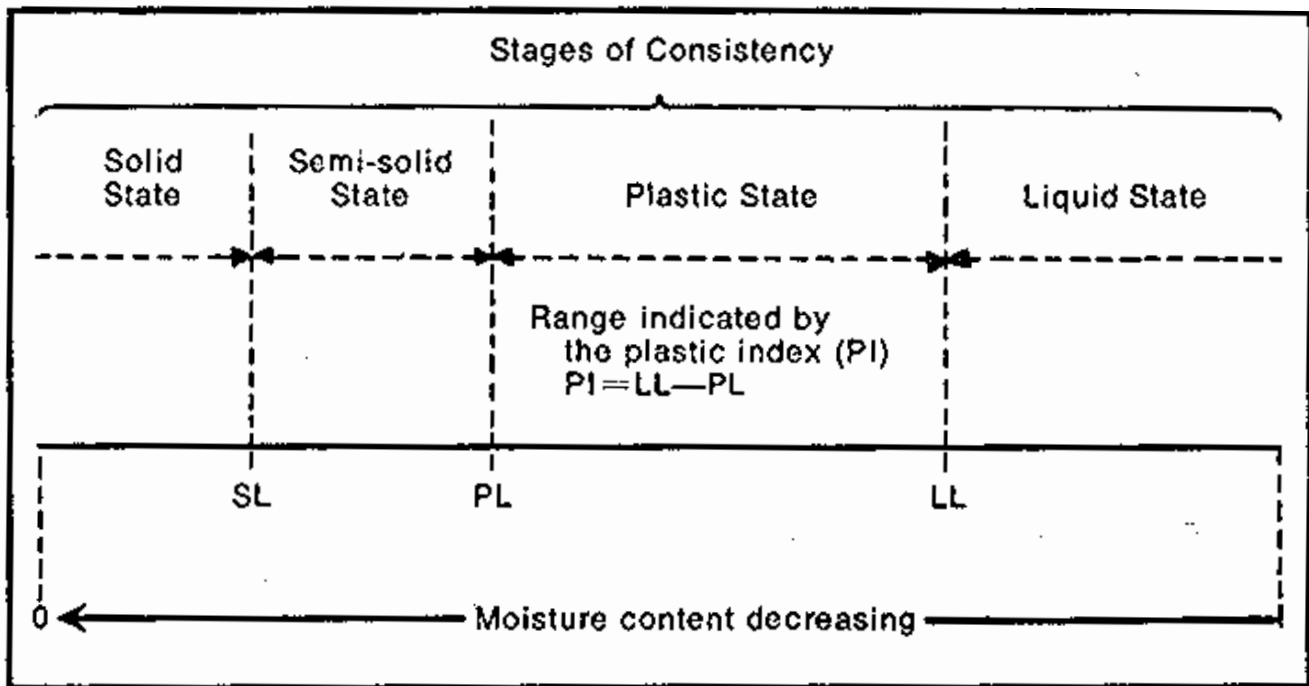

Figure 6

From the above information, seven main groups of soils from A-1 to A-7 are classified.

Group A-1: The typical material of this group is a well-graded mixture of stone fragments or gravel, coarse sand, fine sand, and a non plastic or slightly plastic soil binder.

Group A-2: This group includes a wide variety of granular materials which are at the borderline between materials falling in groups A-1 and A-3 and silt-clay materials of groups A-4 through A-7. This group contains the materials with 35 percent or less passing No. 200 sieve.

Group A-3: The typical material of this group is fine beach sand or fine desert blown sand without silty or clayey fine, or very small amount of nonplastic silt. The group also includes stream-deposited mixtures of poorly graded fine sand and limited amounts of coarse sand and gravel.

Group A-4: The typical material of this group is a nonplastic or moderately plastic silty soil having 75% or more passing the No. 200 sieve.

Group A-5: The typical material of this group is similar to that of group A-4 except the liquid limit for this group is higher.

Group A-6: The typical material of this group is a plastic clay soil usually having 75 percent or more passing the No. 200 sieve. This group also includes mixtures of fine clayey soils and up to 64% of sand and gravel retained on the No. 200 sieve.

Group A-7: The typical material of this group is similar to that of group A-6 except the liquid limit is higher.

The original classification had an A-8 group. This A-8 group is mainly a peat or muck soil. It is characterized by low density, high water content, high organic matter, and high compressibility. It is very unstable material.

In addition to the group classification, one important property that the inspector should know is the group index (GI). The group index is the number in parentheses. The following equation is used to calculate the group index:

$$\text{Group Index} = \text{GI} = (F-35)[0.2 + 0.005(\text{LL} - 40)] + 0.01(F - 15)(\text{PI} - 10)$$

Where:

F: Percentage passing No. 200 sieve

LL: Liquid limit

PI: Plasticity index

According to the Standard Specifications, when the group index determined by the 1991 method is 30 or higher, the soil is considered unsuitable. However, Soils Design may make project-specific exceptions to this general rule (typically raising it above 30). Thus, Soils Design sheets may show soils with a GI above 30 that is still marked as suitable, and feasibly soils with a GI below that are marked unsuitable.

b. Textural Classification

Another classification that the IDOT uses is the USDA textural classification. From this method, the soil will be described as loam, silty loam, clay loam, etc. These descriptions are frequently abbreviated on the soil sheets as L, S. L., C.L., etc. For a grading project, the soils are classified in 12 common textural classes. The gradation of the soil is first determined. From the gradation, different classes are defined. This method does not consider the gravel portion or content. Thus, the sand, silt, and clay contents are prorated so the sum is 100 percent. In addition, if the gravel content is 10% or more, the term “gravelly” will be put in front.

Example: The gradation analysis shows the gravel, sand, silt, and clay contents are 4, 31, 44, and 21 respectively. What is the textural class of this soil?

Since the gravel content is not considered in this method, the sand, silt, and clay contents must be prorated. The prorated contents are:

$$\text{Sand} = 31 * (100/96) = 32\%$$

$$\text{Silt} = 44 * (100/96) = 46\%$$

$$\text{Clay} = 21 * (100/96) = 22\%$$

Figure 7 gives the textural class as loam.

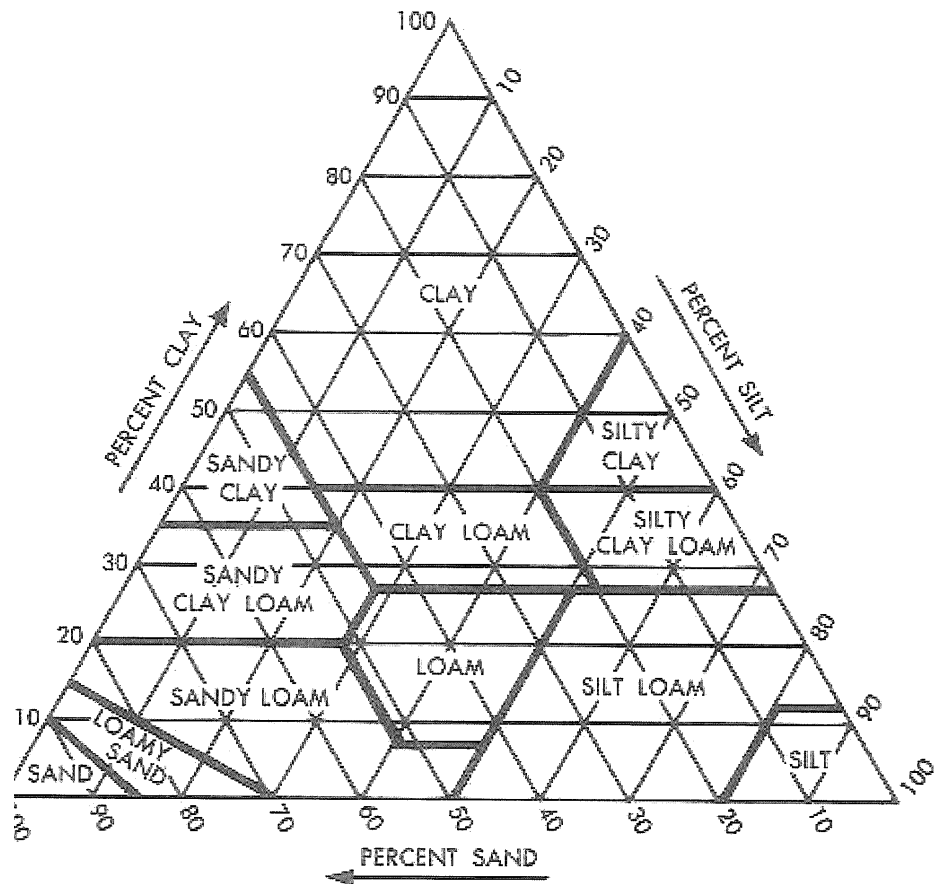

Figure 7. Textural Classification

2. Shear Strength

What is the shear strength of a soil? It is mainly the ability of a soil to resist shear failure along a certain rupture plane or zone. The shear strength of a soil comes from the cohesion, friction, or combination of both. There are two groups of factors that would affect the shear strength of a given soil. The first group includes the void ratio of the soil and the confining stresses. The second group includes the size, the shape, and the gradation of the particles making up the soils. Sand and gravel have no real cohesion. A cohesive soil, on the other hand, obtains the shear strength mainly from cohesion. In some instances when a new embankment is constructed, part of the “load” will be carried by the water held within a saturated soil. However, as time goes by, the water escapes from the soil which means that the friction between the particles is more effective. Thus, the shear strength can increase with time.

3. Iowa DOT Material Classifications and Unsuitable Placement Requirements

Roadway and borrow excavation is divided into the following classifications:

- Class 10
 - Unsuitable soil
 - Suitable soil
- Class 12
- Class 13
- Select Soils

Excerpts from the Standard Specifications Section 2102 (in the Reference Manual) provide additional information regarding the classifications listed above.

Standard Road Plan EW-102 (in the Reference Manual) shows where unsuitable soils are allowed to be placed in the roadway. The inspector must be sure that the earthwork is performed according to the plans and contract requirements.

4. Soil Sheets

The soil sheets are very important to the grading inspector and the contractor. These sheets should provide the key to building a quality project and production. There is a lot of information on the soil sheet. Please see the three attached Q-sheets. The typical information includes cut moisture, cut density, plastic limit, Shelby tube core data, AASHTO classification and group index, color and textural classification, the abbreviated color and description, proctor density and optimum moisture content, water table, etc. The following are some general descriptions and discussions of each term:

Cut Moisture: Moisture of in-place soil at location indicated for “core” in the boring. This information should be compared to the proctor density information so that the inspector would have some idea how wet the soil is and how much discing would need to be done. It may provide some information on whether or not a backslope subdrain is needed at the cut area.

Cut Density: Density of in-place soil at location indicated for “core” in the boring. Similar to the cut moisture, the cut density may provide some information on shrinkage. For example, the cut density is 95 pcf and the Proctor density is 105 pcf. Thus, there should be at least 10% shrinkage if compacted to 100% Proctor. However, the current practice without any actual testing, this guide is not applicable.

Plastic Limit: This term was defined earlier.

Shelby Tube Core Data: This is an undisturbed Shelby Tube sample. It is usually taken in an area where a fill is proposed or the soil investigation indicates that there may be a soft layer that may experience some settlement upon loading. A triaxial test is run on this sample to determine the cohesion, internal friction angle, consolidation coefficient, etc. The results are used for slope stability analysis, settlement prediction, etc. which will determine whether berms, blankets, core-outs, etc. are necessary.

AASHTO Classification and Group Index: These terms were also defined earlier.

Color and Textural Classification: The color and textural description are the preliminary remarks described by the soil crew during the drilling. Sometimes they are not the same as the abbreviated textural classification.

Abbreviated Color and Textural Classification: The textural classification was defined earlier. However, the color of the soil was not discussed. Soil color is a function of surface coatings which constitute only a small percentage of the soil. For example, an intense rusty red-brown signifies iron oxide coating. On the other hand, a white crusty appearance indicates calcium carbonate coating. The water table and air have a lot to do with the color of the soils. Dark gray or green or blue hues indicate conditions of greying, which occurs below a permanent water table. When the soils are exposed to the air, the colors will change.

Proctor Density and Optimum Moisture Content: These two terms will be defined in more detail later in “Soil Compaction” section. Proctor density is the maximum density that a given soil can be compacted at the proper or optimum moisture content. This moisture content provides important information on what moisture content the soil should be during compaction to obtain adequate compaction.

Water Table: The water table is indicated as the little dash-line with the symbol H₂O. This is what was found during the soil investigation. This water table should give some good indication on how wet the soil is and whether or not a backslope subdrain is needed.

Subgrade Treatment: Subgrade treatments are used to provide the best possible support for the subbase (if needed) and the pavement. The type of subgrade treatment material used depends on the type and quality and quantity of natural soils available on the project. Standard subgrade treatment per Standard Road Plan EW-103 is provided in the Reference Manual.

5. Soil Compaction

Figure 8 shows that soil is made up of solids (soil particles), liquid (water) and gas (air). Compaction is the act of densifying the soil by pressing soil particles together into close contact. As a result, air is removed from the soil body.

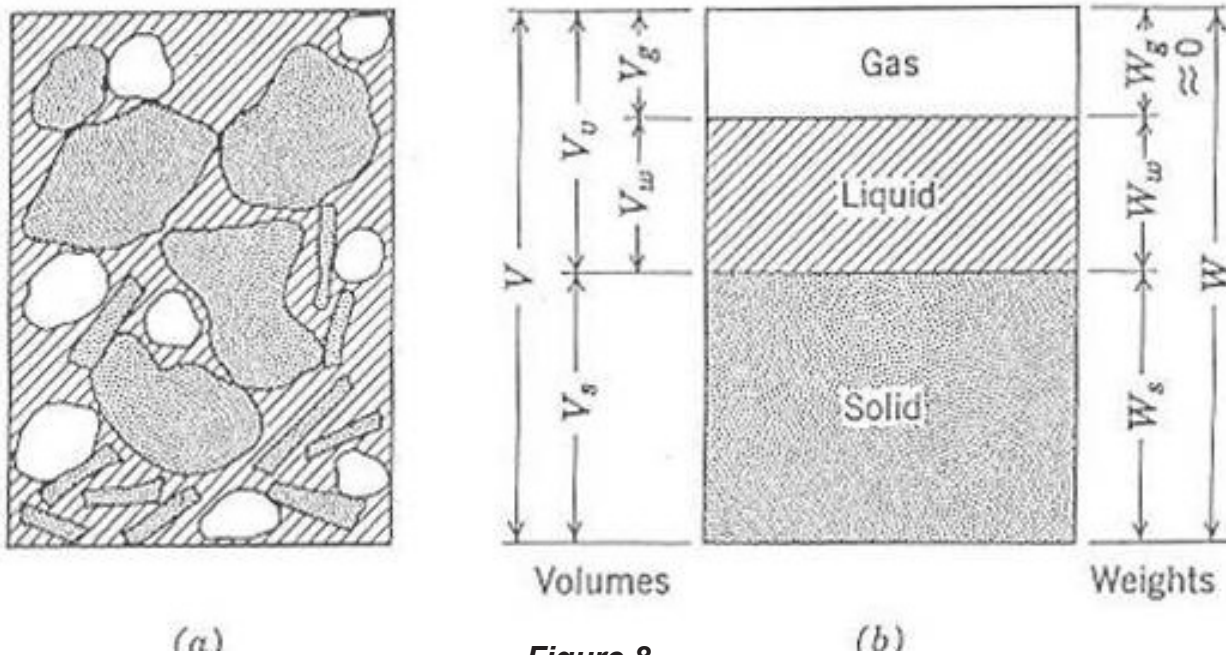

Figure 8

This increases the strength of the soil and reduces the permeability. In the “shear strength” section, it was said void ratio affects the shear strength. This, once again, indicates the importance of proper compaction of the soil. The most important factors when it comes to soil compaction are:

- Soil type
- Moisture content
- Lift thickness
- Equipment

In order to determine the soil type, the soil classification is done. This topic and the soil properties were discussed earlier.

Proctor density curve

For moisture content information, a Proctor density relationship should be established. R. R. Proctor, the Los Angeles County Engineer, discovered an important relationship between soil density and moisture content. Proctor found that by molding a series of specimens with different moisture contents, using the same compactive effort for each specimen, the density on a dry-weight basis would peak out as shown in Figure 9.

A Proctor density curve or test should be done when there are some questions about the soil. The method of running a proctor density is in the appendix. The theory behind this relationship is that during compaction, moisture or water is needed to provide the lubrication between soil particles and hence improve compaction. However, it is not good to compact soil too far away from the optimum moisture content. When the moisture is too low, soil particles are prevented from sliding. Thus, good compaction would be hard to obtain. On the other hand, when moisture is too high, soil particles cannot come in contact with each other. Unlike gases, water is an incompressible material. Consequently the compactive effort will rework the soil, shearing it, and reducing its strength.

Over-compaction is a condition which occurs when a large compactive effort is put into soil which is too wet for proper compaction. The compactive effort causes the wet soil particles to slide over/across each other into such a configuration where they have a “preferred orientation”, which in turn produces “weak zones” which, along with low density, produce a soft, weak, unstable embankment. For this reason, the hauling pattern must be considered. If it is possible, the trucks should be running on the shoulder. If it is not possible, the wheel tracks should spread out across the grade instead of one location, i.e., not driving in the same wheelpath. When the top of the grade is used for traffic hauling for a while, it is highly recommended that the top layer be scarified and recompacted. This will remove the overcompacted layer with shearing zone.

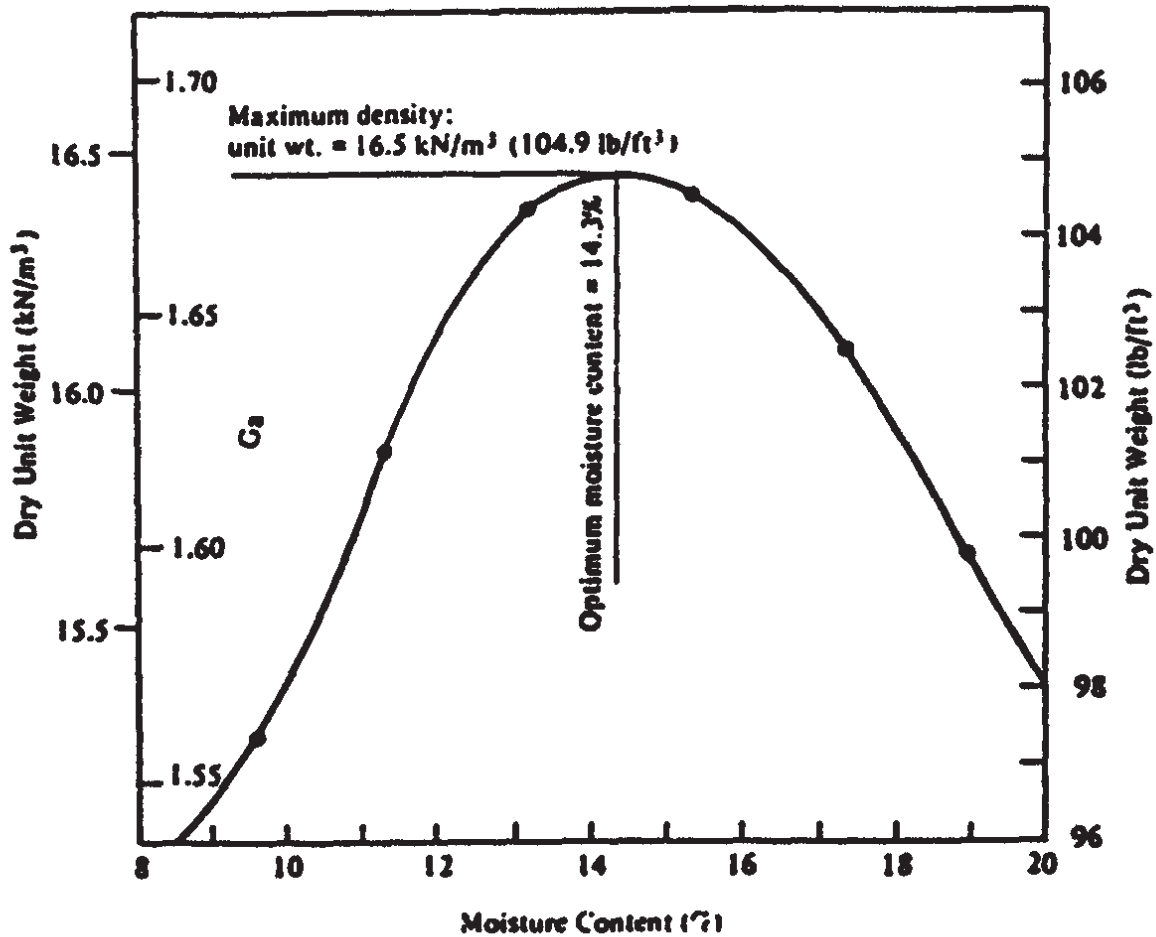

Figure 9 - Sample Proctor Density Curve

Equipment

Compaction can be obtained by rollers or devices with different forces. These forces are pressure, impact, vibration, and manipulation. Figure 10 shows various types of compactors and the type of material for which they are best suited.

Pressure is mainly the downward force applied by the roller. Impact and vibration are from series of blows. Manipulation is the kneading action within the soil.

The specification requires the pressure of the roller be not less than 200 psi. It is important to check the pressure of the roller.

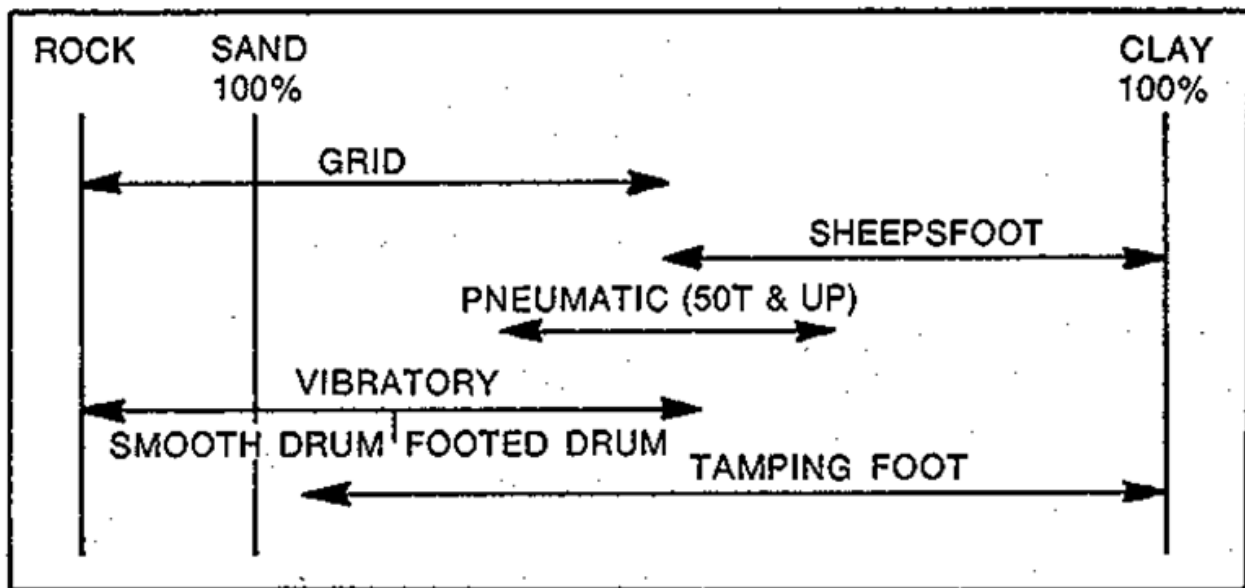

Figure 10

Source: *Hyster Compaction Handbook*

Compaction

Type A compaction is normally required. This means the lift thickness before compaction should be 8 inches or less and there will be at least one rolling per inch depth of each lift. The rolling will be done until the tamping feet penetrate not more than 3 inches into the 8 inch lift. This is the roller walkout requirement.

Once again, since there is no moisture requirement for compaction and the different soils behave differently, it could be very misleading to require the same pattern and the same equipment for all soils. With the proper moisture content, the compactive effort to get good density should be lower. It would be best if the rolling pattern, the lift thickness, and the approximate moisture content could be determined for the roller being used with a specific soil. This means that some density be taken at the beginning to determine the number of passes, the lift thickness, etc. Please keep in mind that the lift thickness should not be more than two inches thicker than the length of the tamping feet.

For cohesive soils, a sheepfoot roller should be used (Figure 11). However, for granular soils, a sheepfoot is not appropriate and a vibratory roller is the preferred equipment.

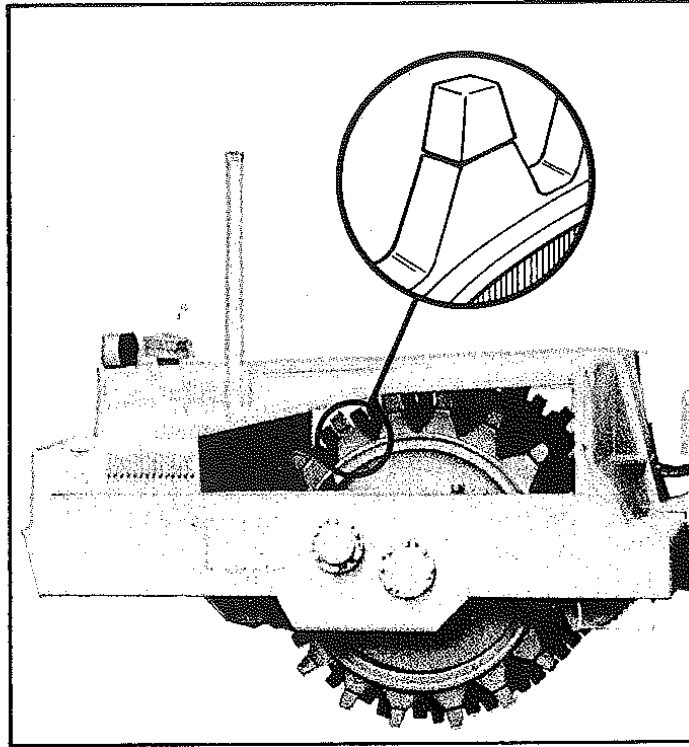

Figure 11

Source: Hyster Compaction Handbook

How to Calculate Moisture Content

Moisture content is defined as:

$$\text{Moisture Content, mc, \%} = (100 \times \text{mass of water in the sample}) / (\text{mass of dry soil})$$

For example:

A pan with a mass of 211.3g was used to dry a wet mass of soil of 564.0 g. Thus, the mass of the wet soil and the pan is 775.3g.

After drying soil sample on the stove, the mass of the dry soil and the pan is 714.5g.

Thus, the mass of the water in the soil is the difference in mass between the wet and the dry soil which is $775.3\text{g} - 714.5\text{g} = 60.8\text{g}$.

The mass of the dry soil by itself without the pan is $714.5\text{g} - 211.3\text{g} = 503.2\text{g}$.

Hence, the moisture content in the soil is $(100 \times 60.8) / (503.2) = 12.1\%$

Sample Number	XXXX
Mass of wet soil + Pan, A	775.3g
Mass of dry soil + Pan, B	714.5g
Mass of Pan, C	211.3g
Mass of dry soil, $D = B - C$	503.2g
Mass of water, $E = A - B$	60.8g
Moisture content, $F = 100 \times E / D$	12.1%

Please report the percent of moisture content to the nearest 0.1 percent.

Moisture Content Calculations

Sample Number	1
Mass of wet soil + Pan, A	123.3g
Mass of dry soil + Pan, B	110.5g
Mass of Pan, C	33.3g
Mass of dry soil, $D = B - C$	_____g
Mass of water, $E = A - B$	_____g
Moisture content, $F = 100 \times E / D$	_____%

Sample Number	2
Mass of wet soil + Pan, A	222.5g
Mass of dry soil + Pan, B	206.2g
Mass of Pan, C	61.3g
Mass of dry soil, $D = B - C$	_____g
Mass of water, $E = A - B$	_____g
Moisture content, $F = 100 \times E / D$	_____%

Sample Number	3
Mass of wet soil + Pan, A	175.4g
Mass of dry soil + Pan, B	151.5g
Mass of Pan, C	42.3g
Mass of dry soil, $D = B - C$	_____g
Mass of water, $E = A - B$	_____g
Moisture content, $F = 100 \times E / D$	_____%

**See
Answers on
Next Page**

Moisture Content Solutions

Sample Number	1
Mass of wet soil + Pan, A	123.3g
Mass of dry soil + Pan, B	110.5g
Mass of Pan, C	33.3g
Mass of dry soil, $D = B - C$	77.2g
Mass of water, $E = A - B$	12.8g
Moisture content, $F = 100 \times E / D$	16.6%

Sample Number	2
Mass of wet soil + Pan, A	222.5g
Mass of dry soil + Pan, B	206.2g
Mass of Pan, C	61.3g
Mass of dry soil, $D = B - C$	144.9g
Mass of water, $E = A - B$	16.3g
Moisture content, $F = 100 \times E / D$	11.2%

Sample Number	3
Mass of wet soil + Pan, A	175.4g
Mass of dry soil + Pan, B	151.5g
Mass of Pan, C	42.3g
Mass of dry soil, $D = B - C$	109.2g
Mass of water, $E = A - B$	23.9g
Moisture content, $F = 100 \times E / D$	21.9%

How to Determine Proctor Density

Moisture content was discussed previously. The next step is to learn how to calculate the wet and dry density. Let's read the Iowa Materials IM 309. There are two test procedures in the IM. One procedure is the multiple points and the other is the one point. It is recommended that the multiple points be used at first to get some good data before going to the one point procedure. Also, please recognize that the calculation and data used are a little different for each method.

Density is defined as:

$$\text{Density} = \text{Mass} / \text{Volume}$$

For example: A boy with help from his father built an one-cubic foot box. He decided to fill that box with sand. He weighed the sand with his mother's scale and found that it took 120 pounds of sand to fill the box evenly to the top. Thus, the density of the sand in this boy's box is 120 pounds per cubic foot (120 pounds/1 cubic foot).

The density which is mentioned is usually "dry density". Thus, when the density is checked in the field, it is the wet density. Therefore, the moisture will have to be accounted for. The relationship between dry density and wet density is defined as:

$$\text{Dry Density} = \text{Wet Density} / (1 + (\text{Moisture Content} / 100))$$

The boy with the curious mind decided to explore a little further with the moist sand. Using his mother's kitchen scale he weighed 108 grams of sand and put the sand in a pan. He turned the stove to low heat to dry the moist sand. After drying, he weighed the dry sand. The scale indicated that the weight was 104 grams. Thus:

$$\text{Moisture Content in the sand, \%} = (100 \times (108 - 104)) / 104 = 3.8\%$$

Hence, the dry density of the sand in the box is:

$$\text{Dry Density} = 120 \text{ pcf} / (1 + (3.9/100)) = 115.5 \text{ pcf}$$

During the testing of the Proctor density, similar calculations will be performed.

The weights for the Proctor mold, Proctor mold with the compacted soil, moisture content pan, moisture content pan with wet soil, moisture content pan with dry soil will be recorded for the calculations. Please understand some conversion factors.

To convert from pounds per cubic foot to kg per cubic meter, multiply by 16. For example $115.5 \text{ pcf} \times 16 = 1848 \text{ kg/m}^3$

$$1000\text{g} = 1 \text{ kg}$$

$$453.6\text{g} = 1 \text{ lb.}$$

$$1 \text{ kg} = 2.2 \text{ lbs.}$$

$$\text{Proctor mold volume} = 1/30 \text{ ft}^3 = 0.000944 \text{ m}^3$$

The scale will be in metric unit, i.e.: grams. Thus, the weight is in metric but the volume is in English. In order to come up with pounds per cubic foot at the end, the weight of the compacted soil in grams will have to be multiplied by 0.06614.

$$0.06614 = \frac{1}{453.6 \text{ g/lb} * 1/30 \text{ ft.}^3}$$

Calculations

$$\text{Proctor mold, M} = 1350.0\text{g}$$

$$\text{Proctor mold + soil} = 3088.7 \text{ g}$$

Proctor Mold mass, G	1350.0g
Soil and Mold mass, H	3088.7g
Soil mass, I = H - G	1738.7g
Wet Density, J = I x 0.06614	115.0 pcf
Wet Density, K = J x 16	1840 kg/ m ³

Taking and drying a sample to determine the moisture content, it was found that the moisture content of the compacted Proctor density sample is 12.1%. Using what was discussed before on the previous page the dry density is determined as:

$$\text{Dry Density} = \text{Wet Density} / (1 + (\text{Moisture Content} / 100))$$

$$\begin{aligned} \text{Dry Density} &= 115.0 / (1 + (12.1 / 100)) \\ &= 115.0 / (1 + (0.121)) \\ &= 115.0 / 1.121 \\ &= 102.6 \text{ pcf} \end{aligned}$$

Wet Density, J	115.0 pcf
Dry Density, L = J / (1 + mc / 100)	102.6 pcf

During the calculations, please report the density to the nearest 0.1 pound per cubic foot. Final density may be rounded to the whole number.

Summary

Mass of wet soil + Pan, A	A	775.3g
Mass of dry soil + Pan, B	B	714.5g
Mass of Pan, C	C	211.3g
Mass of dry soil, D = B - C	D	503.2g
Mass of water, E = A - B	E	60.8g
Moisture content , F = 100 x E / D	F	12.1%
Proctor Mold mass, G	G	1350.0g
Soil and Mold mass, H	H	3088.7g
Soil mass, I = H - G	I	1738.7g
Wet Density , J = I x 0.06614	J	115.0 pcf
Dry Density , L = J / [1 + (F / 100)]	L	102.6 pcf

Data and calculations from moisture content sample from Proctor core

Data and calculations from Proctor

Calculation using moisture content and wet density

Proctor Density Calculation

	Point 1	Point 2	Point 3	Point 4	Point 5
Mass of wet soil + Pan, A, in grams A					
Mass of dry soil + Pan, B, in grams B					
Mass of Pan, C, in grams C					
Mass of dry soil, D = B - C, in grams D					
Mass of water, E = A - B, in grams E					
Moist. Content , F = 100 x E / D , in % F					
Proctor Mold mass, G, in grams G					
Soil and Mold mass, H, in grams H					
Soil mass, I = H - G, in grams I					
Wet Den , J = I x 0.06614, in pcf J					
Dry Den , L = J / [1 + (F / 100)], in pcf L					

Proctor Density Calculation

		Point 1	Point 2	Point 3	Point 4	Point 5
Mass of wet soil + Pan, A, in grams	A	750.3	703.0	701.3	625.4	661.2
Mass of dry soil + Pan, B, in grams	B	684.0	637.7	624.5	545.3	570.0
Mass of Pan, C, in grams	C	80.0	112.1	97.4	98.2	95.1
Mass of dry soil, D = B - C, in grams	D	604.0	525.6	527.1	447.1	474.9
Mass of water, E = A - B, in grams	E	66.3	65.3	76.8	80.1	91.2
Moist. Content , F = 100 x E / D , in %	F	11.0	12.4	14.6	17.9	19.2
Proctor Mold mass, G, in grams	G	1859.3	1859.3	1859.3	1859.3	1859.3
Soil and Mold mass, H, in grams	H	3610.2	3641.2	3687.0	3743.3	3757.9
Soil mass, I = H - G, in grams	I	1750.9	1781.9	1827.7	1884.0	1898.6
Wet Den , J = I x 0.06614, in pcf	J	115.8	117.9	120.9	124.6	125.6
Dry Den , L = J / [1 + (F / 100)], in pcf	L	104.3	104.9	105.5	105.7	105.4

Draw the Proctor Density curve using points from the above 5 samples.

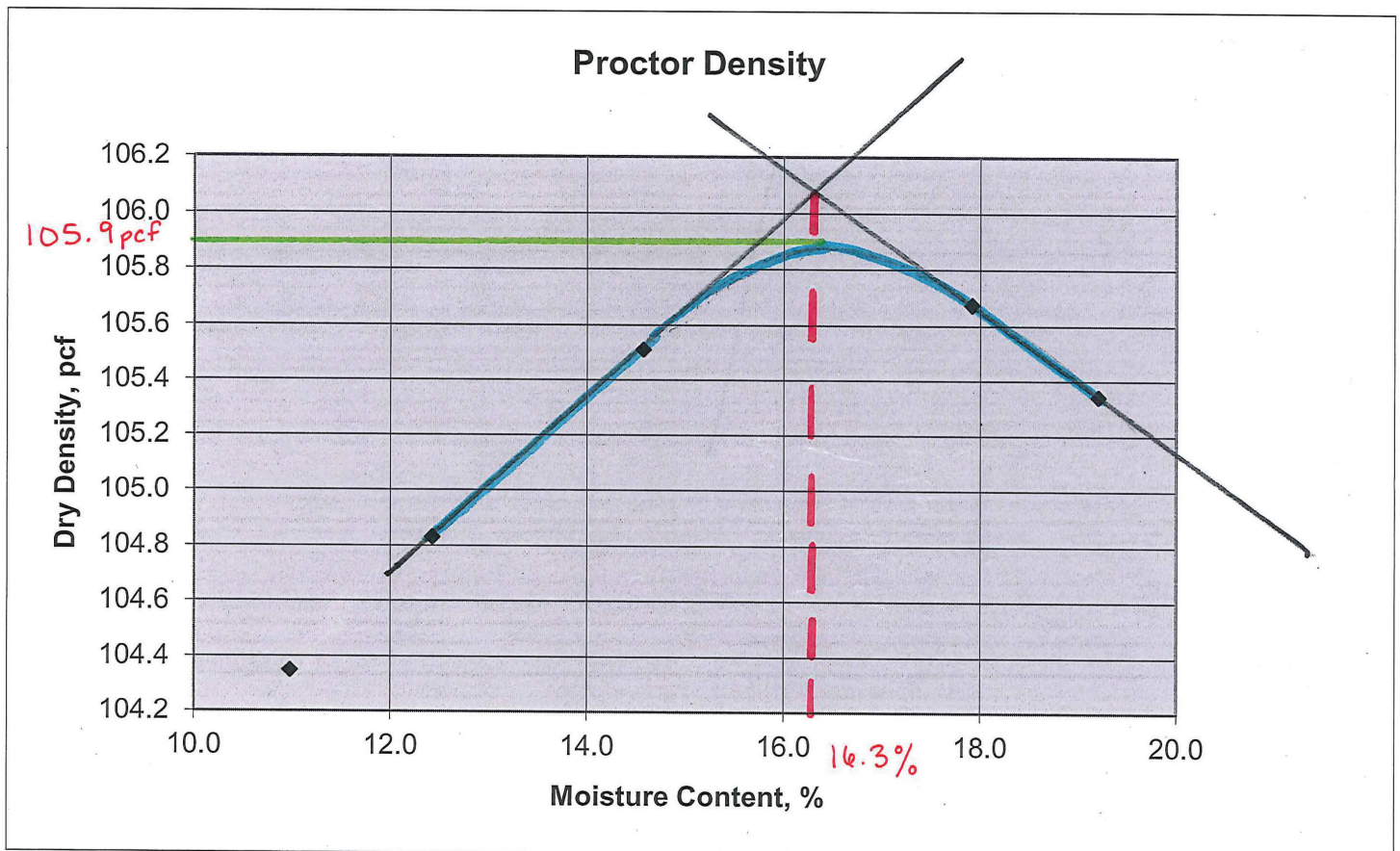

Proctor Density Calculation Sample #1

		Point 1	Point 2	Point 3	Point 4	Point 5
Mass of wet soil + Pan, A, in grams	A	397.7	392.3	415.8	388.7	385.7
Mass of dry soil + Pan, B, in grams	B	364.4	356.5	373.9	345.1	340.5
Mass of Pan, C, in grams	C	100.1	100.1	100.1	100.1	100.1
Mass of dry soil, D = B - C, in grams	D					
Mass of water, E = A - B, in grams	E					
Moist. Content, F = 100 x E / D , in %	F					
Proctor Mold mass, G, in grams	G	1804.4	1804.4	1804.4	1804.4	1804.4
Soil and Mold mass, H, in grams	H	3574.8	3650.5	3709.4	3745.7	3732.1
Soil mass, I = H - G, in grams	I					
Wet Den, J = I x 0.06614, in pcf	J					
Dry Den, L = J / [1 + (F / 100)], in pcf	L					

Draw the Proctor Density curve using points from the above 5 samples.

Graph paper is available at the "Graphing Paper" tab in this binder

Proctor Density Calculation Sample #2

		Point 1	Point 2	Point 3	Point 4	Point 5
Mass of wet soil + Pan, A, in grams	A	682.2	717.5	679.0	696.2	701.4
Mass of dry soil + Pan, B, in grams	B	629.6	655.3	611.3	616.3	612.3
Mass of Pan, C, in grams	C	112.3	112.3	112.3	112.3	112.3
Mass of dry soil, D = B - C, in grams	D					
Mass of water, E = A - B, in grams	E					
Moist. Content, F = 100 x E / D , in %	F					
Proctor Mold mass, G, in grams	G	1955.1	1955.1	1955.1	1955.1	1955.1
Soil and Mold mass, H, in grams	H	3774.5	3817.5	3880.6	3930.3	3940.6
Soil mass, I = H - G, in grams	I					
Wet Den, J = I x 0.06614, in pcf	J					
Dry Den, L = J / [1 + (F / 100)], in pcf	L					

Draw the Proctor Density curve using points from the above 5 samples.

One-Point Proctor

Let's go one step further by using the values of wet density and moisture content to determine dry density using the graph from IM 309.

For example, the wet density for the first point is 115.0 pcf and the moisture content is 12.1 %, from the graph, with roughly 12% at the bottom on the horizontal axis going up and at 115 pcf on the vertical axis going across, it looks like the two lines should meet in between Curve 23 and Curve 24. Curve 23 indicates the dry density of 107 pcf at moisture content of 17.5. Curve 24 indicates the dry density of 106 pcf at moisture content of 18.0%. Use your judgment call in making the decision. Please do the following exercise.

Using Test Method 103-D

<i>Wet Density, (pcf)</i>	<i>Moist. Content, (%)</i>	<i>Curve No.</i>	<i>Dry Density, (pcf)</i>	<i>Moist. Content, (%)</i>
<i>118.0</i>	<i>13.8</i>			
<i>121.8</i>	<i>15.9</i>			
<i>124.6</i>	<i>17.7</i>			
<i>125.6</i>	<i>19.6</i>			

Moisture Control Requirements

By now it should be clear that in order to improve quality of the earthwork construction, moisture contents during compaction are important. When the soil is compacted near the optimum moisture content, the density is high. As the moisture dissipates, the shear strength will significantly improve. There is a difference between density and stability. During compaction, for a cohesive soil, the density increases as the moisture content increases to optimum moisture content. It then decreases as the moisture content increases. The stability, on the other hand, decreases as the moisture content increases. From the long term performance, it is better to have good density and somewhat acceptable stability at first than having good stability at first and later having settlement problem. Since there are many types of soils, many designers, many owners, there may be different moisture content limits in different contracts. Please review the contract documents to insure compliance.

1. Moisture Content Limits

Moisture control limits are found in Specifications Section 2107. The moisture control limits sometimes are included in plan notes or estimate reference information. Whatever the limits are, the moisture content during compaction will have to be within the limits.

2. Testing Frequency

The moisture content will have to be determined for each layer before compaction. Depending on how large a spread area is, more than one sample may be needed to be in compliance with the contract documents. Refer to IM 204, Appendix A for sampling and testing frequencies.

3. Moisture Content Test Procedure

Refer to IM 204, Appendix A for acceptable test methods to determine moisture content.

Moisture and Density Requirements

Sometimes both moisture and density are required. This means that the moisture content during the compaction must be within the limits that a certain percentage of the maximum density can be obtained. Also, the compacted layer is checked to insure compliance with the contract requirements in density. There are two steps to meet the requirements. First, the moisture content will have to be determined to confirm moisture is within moisture limits. Second, the density of the compacted layer will have to be checked for density requirement. See section on Density Measurement for how to determine percent compaction.

Moisture content determination was discussed earlier. Again, different methods could be used to determine density of the compacted layer. Refer to IM 204, Appendix A for acceptable test methods to determine in-place density.

Please review the contract documents to insure compliance.

Other Potential Requirements

There is a chance that a stability requirement may be included. This means a degree of stiffness or penetration resistance is required. One method for stability is the dynamic cone penetrometer (DCP) which measures the penetration per blow into the compacted layer. Another is the use of intelligent compaction rollers.

Density Measurement

A small cylinder with a volume of 0.0111 cubic foot or 314.0 cubic centimeters was used to check the density of the compacted layer. The cylinder empty weight (WE) is 243.1 grams. It was driven into the compacted layer and a shovel was used to dig it up. The excess soil was trimmed off and the cylinder with the soil has the weight (WWS) of 822.1 grams. The density of the compacted layer can be calculated in the following paths:

For metric unit:

$$\begin{aligned}\text{Weight of soil, WS} &= \text{WWS} - \text{WE} \\ &= 822.1\text{g} - 243.1\text{g} = 579.0\text{g}\end{aligned}$$

$$\begin{aligned}\text{Wet Density, WD, kg/cubic meter} &= 1,000 * (\text{WS}/\text{Vol}) \\ &= 1,000 * (579.0/314.0) \\ &= 1,844 \text{ kg/cubic meter}\end{aligned}$$

For English unit:

With the same information as the example above, weight of soil in grams is converted to pounds by dividing it by 454.

$$\text{Weight of Soil, WS, in pounds} = 579.0/454 = 1.2753 \text{ pounds}$$

With the volume of 0.0111 cubic foot, the wet density is:

$$\begin{aligned}\text{Wet Density, WD, pcf} &= \text{WS}/\text{Vol} \\ &= 1.2753/0.0111 = 114.9 \text{ pcf}\end{aligned}$$

Practice Sample:

$$\begin{aligned}\text{WE, grams} &= 700.4 \\ \text{WWS, grams} &= 2,508.5 \\ \text{Vol.} &= 0.0332 \text{ cubic foot or } 939.8 \text{ cubic centimeters.}\end{aligned}$$

For metric unit:

$$\begin{aligned}\text{Weight of soil, WS} &= \text{WWS} - \text{WE} \\ &= \underline{\hspace{2cm}} \\ \text{Wet Density, WD, kg/cubic meter} &= 1,000 * (\text{WS}/\text{Vol})\end{aligned}$$

$$\text{Wet Density, kg/cubic meter} = \underline{\hspace{3cm}}$$

For English unit:

With the same information as the example above, weight of soil in grams is converted to pounds by dividing it by 454.

$$\text{Weight of Soil, WS, in pounds} = \underline{\hspace{2cm}}/454 = \underline{\hspace{2cm}} \text{ pounds}$$

$$\text{Wet Density, WD, pcf} = \text{WS}/\text{Vol} = \underline{\hspace{3cm}}$$

Another Example:

During the construction of the embankment, a small cylinder with a volume, Vol, of 0.0111 cubic foot was used to check the density of the compacted layer. The weight of the cylinder, WE, is 1.50 pounds. After the cylinder was driven into the compacted layer and retrieved, the excess soil was trimmed. The weight of the cylinder with the compacted soil, WWS, is 2.83 pounds. Thus,

$$\text{Wet Density, WD, pcf} = (\text{WWS}-\text{WE})/(\text{Vol}) = (2.83-1.50)/(0.0111) = 119.82 \text{ pcf.}$$

This is the wet density. However, when density is discussed, normally it is dry density. Thus, the wet density must be converted to dry density. In order to do this, a sample is taken and dried out to determine the moisture content. Assume this was done and the moisture content is 15.6%. Hence, the dry density is:

$$\text{Dry density} = \text{Wet density}/(1+(\text{mc}/100))$$

$$= 119.82 \text{ pcf}/ (1+(15.6/100)) = 119.82 \text{ pcf}/ 1.156 = 103.65 \text{ pcf}$$

Let's go one step further determining percent compaction:

The moisture control during compaction is minus 1 to plus 3 percent points of optimum moisture content and the density must be at least 95% of maximum dry density. A Proctor density was developed with the maximum density of 108 pcf at the optimum moisture content of 15.8%. Using the density information of the compacted layer from the above example, what is the compaction percent compared to maximum dry density?

$$\text{Percent Compaction} = 100 * (\text{in place dry density}/\text{maximum dry density})$$

Thus:

$$\text{Percent compaction} = 100 * (103.65/108) = 96.0\%$$

APPENDIX

Appendix

1. Proctor Density Calculation Sample Solutions
2. Clay & Silt Identification Information
3. USDA Identification flowchart

Proctor Density Calculation Sample #1

Pan Number		Point 1	Point 2	Point 3	Point 4	Point 5
Mass of wet soil + Pan, A, in grams	A	397.7	392.3	415.8	388.7	385.7
Mass of dry soil + Pan, B, in grams	B	364.4	356.5	373.9	345.1	340.5
Mass of Pan, C, in grams	C	100.1	100.1	100.1	100.1	100.1
Mass of dry soil, D = B - C, in grams	D	264.3	256.4	273.8	245	240.4
Mass of water, E = A - B, in grams	E	33.3	35.8	41.9	43.6	45.2
Moist. Content, F = 100 x E / D , in %	F	12.6	14.0	15.3	17.8	18.8
Proctor Mold mass, G, in grams	G	1804.4	1804.4	1804.4	1804.4	1804.4
Soil and Mold mass, H, in grams	H	3574.8	3650.5	3709.4	3745.7	3732.1
Soil mass, I = H - G, in grams	I	1770.4	1846.1	1905	1941.3	1927.7
Wet Den, J = I x 0.06614, in pcf	J	117.1	122.1	126	128.4	127.5
Dry Den, L = J / [1 + (F / 100)], in pcf	L	104.0	107.1	109.3	109.0	107.3

Draw the Proctor Density curve using points from the above 5 samples.

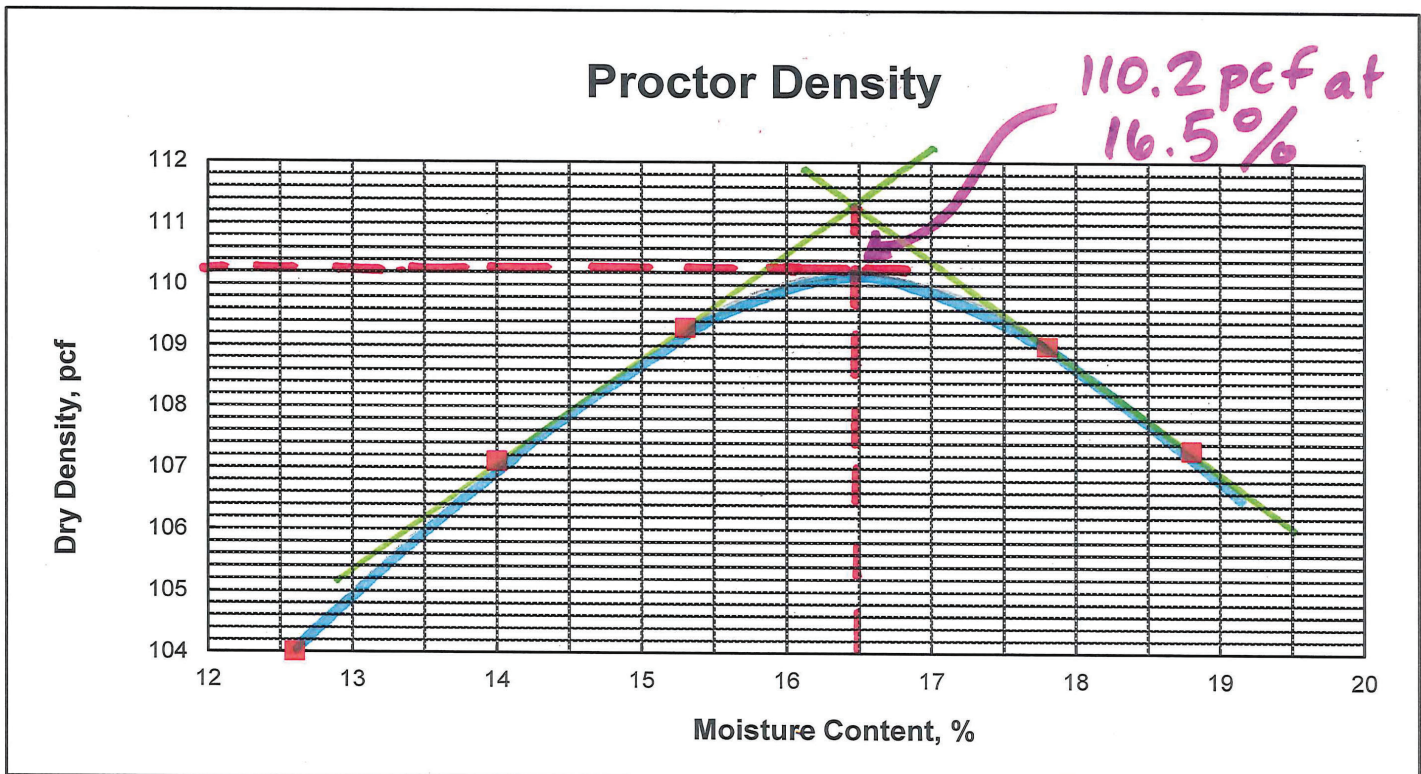

Proctor Density Calculation Solution #2

		Point 1	Point 2	Point 3	Point 4	Point 5
Mass of wet soil + Pan, A, in grams	A	682.2	717.5	679.0	696.2	701.4
Mass of dry soil + Pan, B, in grams	B	629.6	655.3	611.3	616.3	612.3
Mass of Pan, C, in grams	C	112.3	112.3	112.3	112.3	112.3
Mass of dry soil, D = B - C, in grams	D	517.3	543.0	499.0	504.0	500.0
Mass of water, E = A - B, in grams	E	52.6	62.2	67.7	79.9	89.1
Moist. Content , F = 100 x E / D , in %	F	10.2	11.5	13.6	15.9	17.8
Proctor Mold mass, G, in grams	G	1955.1	1955.1	1955.1	1955.1	1955.1
Soil and Mold mass, H, in grams	H	3774.5	3817.5	3880.6	3930.3	3940.6
Soil mass, I = H - G, in grams	I	1819.4	1862.4	1925.5	1975.2	1985.5
Wet Den , J = I x 0.06614, in pcf	J	120.3	123.2	127.4	130.6	131.3
Dry Den , L = J / [1 + (F / 100)], in pcf	L	109.2	110.5	112.1	112.7	111.5

Draw the Proctor Density curve using points from the above 5 samples.

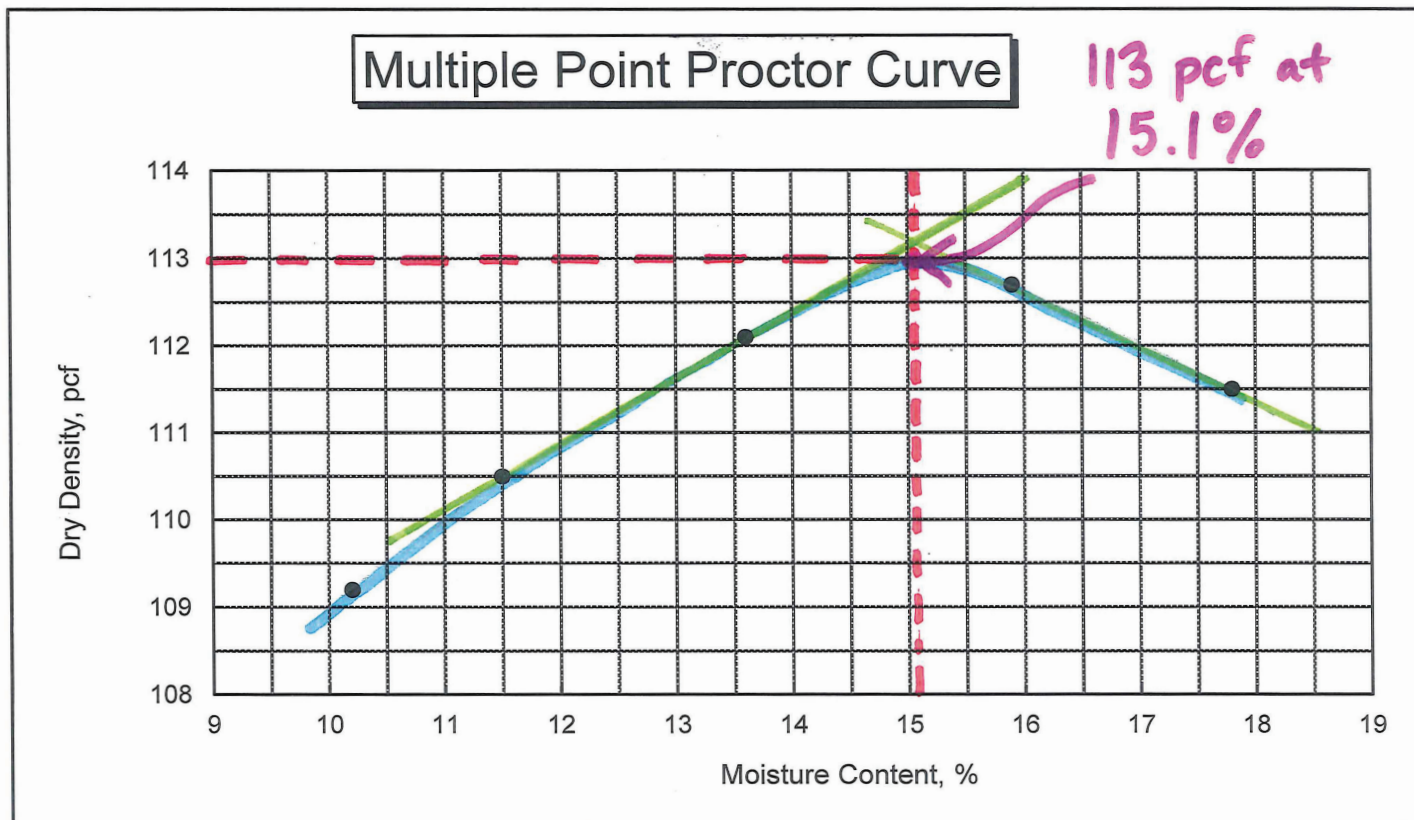

How to define your Soil Texture.

Try this simple exercise:

Take a small sample, moisten it slightly from a water bottle, and work it into a ball between your thumb and fingers,

How long do you have to work a soil between your fingers to get it to a putty-like consistency?

Clay soils can take several minutes. Silty soils can be worked up very quickly.

The first picture is of a silty clay soil. The soil took a long time to work up so it could be easily molded. It contained approximately 40-45% clay.



Will the soil adhere to your thumb as a ball?

Clay soils cannot be easily "flicked" from your thumb. Silty soils can be "flicked" off easily.



Does the soil form "peaks" on your finger and thumb when you pull it apart?

Clay soils form large peaks between your finger and thumb. Silty soils do not form peaks of any significance.

This is a clay soil - see how it peaks easily?



Can you clean the soil off your finger when you rub it across with your thumb?

Clay soils leave their color on your finger. Silty soils can be cleaned right off so that all you see is your finger.



Does the soil feel "soapy" or "buttery" when worked up?

Silty soils feel "soapy". Clay soils feel "buttery".

Try this with a clearly silty soil and a clearly clay soil and you will understand the difference in touch.



From <http://informedfarmers.com/defining-your-soils-texture/>

Table 3-2. Field Tests to Identify Silts and Clays (Atkins)

Test	Method	Result
Grittiness	Rub particles between fingers, or taste	Gritty texture--silt; Smooth texture--clay
Toughness	Take a pat of soil, moist enough to be plastic but not sticky, and roll it to a thread about 3 mm (1/8 in) in size in your palm. Fold and re-roll thread repeatedly until it crumbles. Lump pieces together and knead to measure toughness.	If the soil is tough or stiff, clay content is high. If it crumbles easily, silt content is high.
Shine	Stroke soil with a blade	Dull appearance--silt; Shiny appearance--clay
Dry strength	Allow soil to dry, then squeeze	Powders--silt; Hard to break--clay
Shaking	Squeeze a moistened sample, open hand, then shake or tap your hand	Moisture film comes to surface, glistens--silt; No moisture film—clay

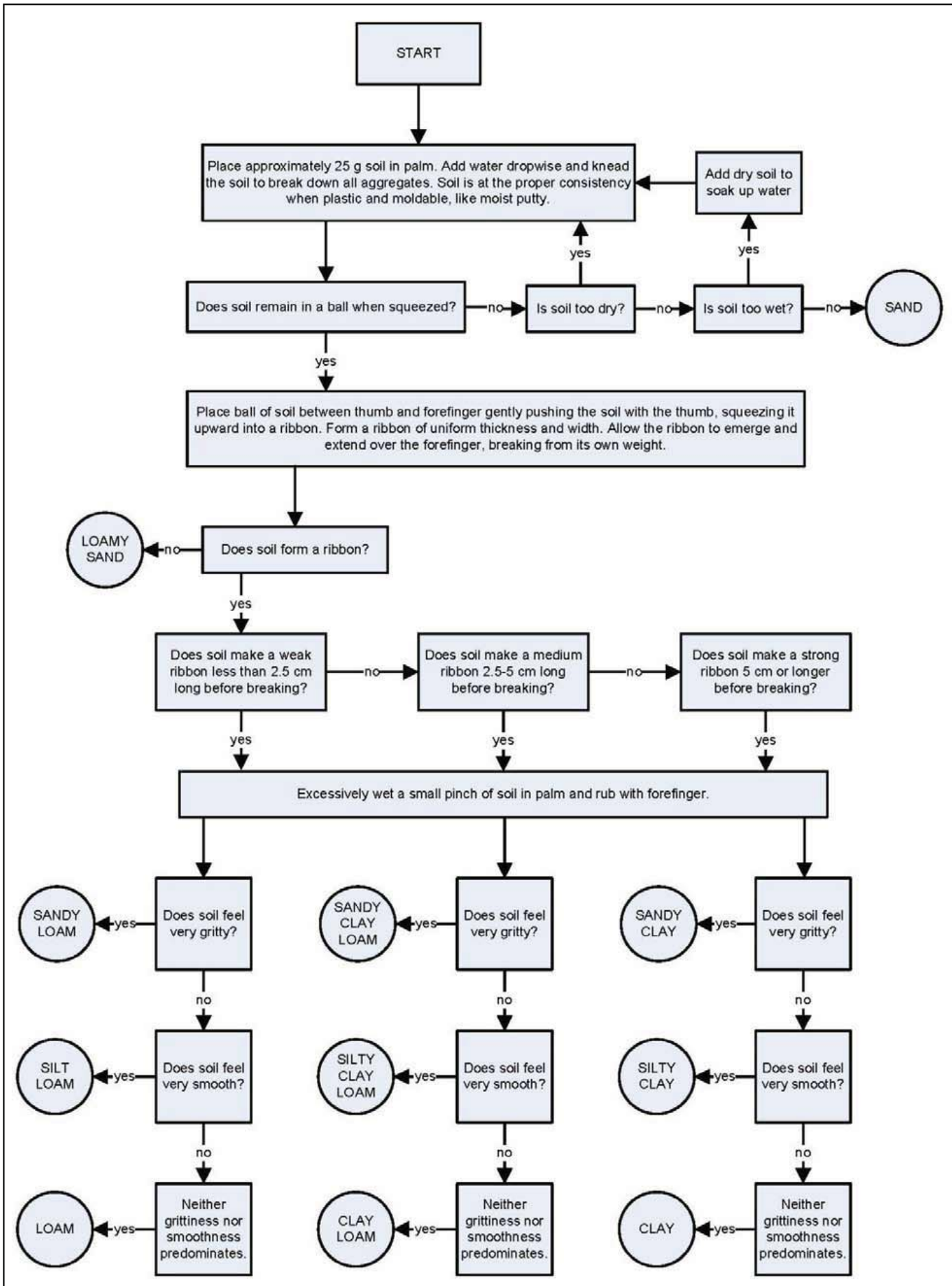

'Texture by Feel' method (modified from Thiel 1979)

REVIEW WORKSHEETS

Soils Certification Review

Answers for review questions are found in your course manual on p. 47.

Pan: 225.7 g
Wet Soil and Pan: 734.9 g
Dry Soil and Pan: 689.5 g

1. What is the moisture content (%)?

2. What is the wet density (pcf)?

Proctor Mold: 1548.2 g
Soil and Mold: 3545.5 g

3. Using answer moisture content from Question 1 and wet density from Question 2, what is the dry density (pcf)?

-
4. Using 1-point proctor curve and moisture content from Question 1 and wet density from Question 2, what is the optimum moisture content and maximum dry density?

Moisture content 9.8% and wet density of 132.1 pcf

-
5. If dry density in the field is 112 pcf, what is percent compaction compared to maximum dry density? Use maximum dry density from Question 4.

-
6. A drive cylinder is used to determine in-place density on a soil lift. The volume of the cylinder is 0.02 ft.³. The mass (in lbs.) of the empty cylinder is 1.2 lbs. The mass of the soil and cylinder is 3.7 lbs. What is the in-place wet density?

If interested in more practice work, you may complete Proctor Density Calculation Sample #2 on p. 23 in your course manual. Answers are then found on p. 34.

Soils Certification Review Solutions

Pan: 225.7 g
Wet Soil and Pan: 734.9 g
Dry Soil and Pan: 689.5 g

1. What is the moisture content (%)?

$$\text{Moisture Content (\%)} = 100 \times \frac{[(\text{Wet Soil} + \text{Pan}) - (\text{Dry Soil} + \text{Pan})]}{[(\text{Dry Soil} + \text{Pan}) - (\text{Pan})]}$$

$$\text{Moisture Content (\%)} = 100 \times \frac{[(734.9 \text{ g}) - (689.5 \text{ g})]}{[(689.5 \text{ g}) - (225.7 \text{ g})]} = 100 \times \frac{45.4 \text{ g}}{463.8 \text{ g}}$$

$$\text{Moisture Content (\%)} = 9.8 \%$$

2. What is the wet density (pcf)?

Proctor Mold: 1548.2 g
Soil and Mold: 3545.5 g

$$\text{Wet Density (pcf)} = [(\text{Soil} + \text{Mold}) - (\text{Mold})] \times 0.06614$$

$$\text{Wet Density (pcf)} = [(3545.5 \text{ g}) - (1548.2 \text{ g})] \times 0.06614 = 1997.3 \times 0.06614$$

$$\text{Wet Density (pcf)} = 132.1 \text{ pcf}$$

3. Using answer moisture content from Question 1 and wet density from Question 2, what is the dry density (pcf)?

$$\text{Dry Density (pcf)} = \frac{\text{Wet Density}}{(1 + \frac{\text{Moisture Content}}{100})} = \frac{132.1 \text{ pcf}}{(1 + \frac{9.8}{100})} = \frac{132.1 \text{ pcf}}{1.098}$$

$$\text{Dry Density (pcf)} = 120.3 \text{ pcf}$$

-
4. Using 1-point proctor curve and moisture content from Question 1 and wet density from Question 2, what is the optimum moisture content and maximum dry density?

Moisture content 9.8% and wet density of 132.1 pcf

Curve 8

Max. dry density: 122 pcf

Optimum moisture content: 11.7%

5. If dry density in the field is 112 pcf, what is percent compaction compared to maximum dry density? Use maximum dry density from Question 4.

$$\% \text{ Compaction } (\%) = \frac{\text{In - Place Dry Density}}{\text{Maximum Dry Density}} \times 100 = \frac{112 \text{ pcf}}{122 \text{ pcf}} \times 100 = 91.8\%$$

6. A drive cylinder is used to determine in-place density on a soil lift. The volume of the cylinder is 0.02 ft.³. The mass (in lbs.) of the empty cylinder is 1.2 lbs. The mass of the soil and cylinder is 3.7 lbs. What is the in-place wet density?

$$\text{In-place wet density} = \frac{(\text{mass of cylinder} + \text{wet soil}) - (\text{mass of cylinder})}{\text{Volume of cylinder}}$$

$$= \frac{3.7 \text{ lb} - 1.2 \text{ lb}}{0.02 \text{ cu. ft.}} = \frac{2.5 \text{ lb.}}{0.02 \text{ cu. ft.}} = \mathbf{125.0 \text{ pcf}}$$

If interested in more practice work, you may complete Proctor Density Calculation Sample #2 on p. 75 in your course manual. Answers are then found on p. 86.

Use Materials IM 312 to find these answers:

	<u>Proctor</u>	<u>Moisture</u>
1. Recommended minimum sample size?	_____	_____
2. How many locations is sample taken from?	_____	_____
3. What is the "R" word for the sample?	_____	_____

Use Materials IM 309 to find these answers:

Sample preparation (Multi-Point Proctor):

1. _____ the field sample to a representative sample of about 5000 grams.
2. Dry the sample to about _____ below the estimated optimum moisture content.
3. Which sieve size is used first? _____
4. What is done with aggregate retained on $\frac{3}{4}$ " sieve? _____

Test procedure:

1. Pulverize the sample until at least _____ of the non-aggregate material will pass the No. 4 sieve.
2. Compact the soil into the mold in _____ layers/lifts.
3. Each layer/lift should be compacted with _____ blows.
4. Height of the last layer/lift should be _____ to _____ inches above the height of the mold.
5. True or False: The sample is extruded from the mold, and then weighed.
6. Slice vertically through the specimen, and a moisture sample of at least _____ grams is taken from _____ of the _____ .

Use Materials IM 335 to find these answers:

1. Dry to a constant weight – this means until the change in two consecutive weighings would have an _____ effect on the calculated water content.
2. If you started with a weight of 500 grams, a change of _____ grams or less should be acceptable.

SPECIFICATIONS
2102

Section 2102. Roadway and Borrow Excavation

2102.01 DESCRIPTION.

Excavate, haul, place, compact, and shape construction materials.

2102.02 MATERIALS.

A. Class 10.

Includes:

- Normal earth materials such as loam, silt, gumbo, peat, clay, soft shale, sand, and gravel.
- Fragmentary rock or boulders handled in the manner normal to this class of excavation.
- Any combination of the above described materials and any other material not classified as Class 12 or Class 13.

B. Class 12.

Includes:

- Granite, trap, quartzite, chert, limestone, sandstone, hard shale, or slate in natural ledges or displaced masses.
- Rock fragments or boulders which occur on the surface or in subsurface deposits mixed with earth, sand, or gravel when their size, number, or location prevents them from being handled in a manner normal to Class 10 excavation.

C. Class 13.

Includes all materials included under the definitions of Classes 10 and 12 and any other material encountered, regardless of its nature.

D. Material Suitability.

1. **Select Treatment Material.**

a. **Cohesive Soils.**

Meet all of the following requirements:

- 1) 45% or less silt size fraction. Silt size particles are 0.074 to 0.002 mm.
- 2) 110 pounds per cubic foot or greater density (AASHTO T 99 Proctor Density or Materials I.M. 309).
- 3) Plasticity index greater than 10.
- 4) A-6 or A-7-6 soils of glacial origin.

b. **Granular Soils.**

Meet all of the following requirements:

- 1) 15% or less silt and clay.
- 2) 110 pounds per cubic foot or greater density (AASHTO T 99 Proctor Density or Materials I.M. 309).
- 3) Plasticity index, 3 or less.
- 4) A-1, A-2, or A-3 (0).

c. **Special Backfill Material.**

Meet the requirements of Section 4132.

d. **Modified Subbase Material.**

Meet the requirements of Section 4123.

2. **Suitable Soils.**

a. Ensure all soils provided for the construction of embankments meet the requirements below. They are suitable when moisture control or moisture and density control is designated.

- 1) 95 pounds per cubic foot or greater density (AASHTO T 99 Proctor Density or Materials I.M. 309).
- 2) AASHTO M 145 index of less than 30.
- 3) Liquid Limit (LL) less than 50.

b. Soils not meeting these requirements are considered unsuitable soils, regardless of classification.

c. When placing soil below water, use clean granular material.

3. **Unsuitable Soils.**

Place in the work only as specified by **Standard Road Plan EW-102**. Use in the work will be according to the definitions in Table 2102.02-1:

Table 2102.02-1: Uses for Unsuitable Soils

Definition	Use
1. Peat or Muck.	Topsoil Applications.
1. Soils with a plasticity index of 35 or greater. 2. A-7-5 or A-5 having a density less than 85 pcf (AASHTO T 99 Proctor Density or Materials I.M. 309).	To be wasted off-site , unless shown otherwise in the contract documents.
1. All soils other than A-7-5 or A-5 having a density of 95 pcf or less (AASHTO T 99 Proctor Density or Materials I.M. 309). 2. All soils other than A-7-5 or A-5 containing 3.0% or more carbon.	Type C placement placed 3 feet below top of subgrade in fills.
1. A-7-6 (30 or greater). 2. Residual clays (overlying bedrock), Paleosols, claypan, gumbo, and gumbotils regardless of classification.	Type B placement placed 5 feet below top of subgrade in fills.
1. Shale. 2. A-7-5 or A-5 soils having a density greater than 86 pcf but less than 95 pcf (AASHTO T 99 Proctor Density or Materials I.M. 309).	Type A placement placed in layers 5 feet below top of subgrade in fills (Alternate layers to consist of suitable soils or Type C placement soils).

E. Selected Backfill Material.

Shown in the contract documents.

F. Special Backfill Material.

Meet the requirements of Section 4132.

2102.03 CONSTRUCTION.

A. General.

1. Prepare the site and construct the embankment according to Section 2107.
2. Remove materials as indicated in the contract documents and from borrow pits, exclusive of that designated as channel excavation.
3. Remove material necessary to provide suitable approaches from intersecting highways and private entrances.
4. Shape and slope materials for construction of the roadbed, slopes, gutters, and inlet and outlet ditches according to these specifications and the alignment, grade, and cross sections shown in the contract documents or established by the Engineer.
5. Before beginning construction, remove grass, weeds, other herbaceous vegetation, and rubbish as provided in Article 2102.03, G.
6. Work around utility poles if it is impractical to remove them before excavation or embankment construction.

B. Classification of Excavation.

1. Class 10 Excavation.

Excavate Class 10 material.

SPECIFICATIONS
2107

Section 2107. Embankments

2107.01 DESCRIPTION.

- A. Prepare the site.
- B. Place and compact excavated materials.

2107.02 MATERIALS.

Specified in the contract documents.

2107.03 CONSTRUCTION.

A. General.

1. Prepare the site, and place and compact excavated materials to the required elevation and cross section shown in the contract documents.
2. If the type of compaction is not specified, Type A compaction will be required.

B. Equipment.

Use equipment that meets the requirements of Section 2001 and the following:

This will be defined on next page.

1. Compaction Equipment.

- a. When compaction with moisture and density control is not specified, use equipment that meets the requirements of Article 2001.05, A. Other types of compacting equipment may be used as provided in Article 2107.03, G.
- b. For compaction of sand or other granular material, use either a:
 - Self propelled pneumatic roller meeting the requirements of Article 2001.05, C, or
 - Self propelled vibratory roller meeting the requirements of Article 2001.05, F.
- c. Compact special backfill material with equipment meeting the requirements of Articles 2001.05, B; C; D; F; or other types of compacting equipment as provided in Article 2107.03, G.
- d. When compaction with moisture and density control is specified, any type of equipment which will produce the desired results may be used for compaction.

This is sheepfoot roller.

2. Equipment for Applying Water.

Apply Article 2001.09.

C. Preparation of the Site.

1. Strip topsoil as required by the contract documents.
2. When an embankment is placed on or against an existing slope which is generally steeper than 3 horizontal to 1 vertical and is more than 10 feet high, cut the slope into steps as the construction of the new embankment progresses. Assure that sod or other potential sliding surfaces are removed. Cut each step or series of steps to approximate horizontal planes with vertical slope cut dimensions of no less than 3 feet.

D. Depositing Embankment Material.

1. Comply with the following:
 - a. Except for rock fills and granular blankets, deposit embankments in horizontal layers not over 8 inches in loose thickness.
 - b. Keep the outer portion lower than its center.
 - c. When construction will be suspended for a period during which rain is likely to occur, smooth the surface to produce a smooth and compact surface to shed water.
 - d. Deposit soils containing quantities of roots, sod, or other vegetable matter outside of the shoulder line and within the outer 3 feet of the embankment.
 - e. Do not deposit tree stumps and other large woody objects in embankments.
 - f. Alternate layers of drier soils with wetter soils whenever it is practical to do so without an increase in average haul.

- g. Do not construct embankments on frozen ground. Do not use frozen material to construct embankments.
2. Apply the following where Type A or Type B compaction operations are to be used:
 - a. When the width at the attained height is 30 feet or more, divide the area upon which the layer is to be placed into separate and distinct dump areas having widths no less than 15 feet. If hauling equipment is operated within a dump area, disk the area with a least one pass of a tandem axle disk or two passes with a single axle disk prior to compaction.
 - b. During compacting operations, keep hauling equipment off dump areas of embankments 36 feet wide or more. Empty hauling units may travel on the dump area during compaction operations as necessary to pass loaded hauling units if:
 - Within 36 feet of a bridge or other limiting structure.
 - The width of the embankment is less than 36 feet at the attained height.
 - c. If the design width of embankment is less than 30 feet at the attained height, hauling units will be allowed to travel through areas where compaction operations are in progress. Ensure hauling equipment passing through compaction operations does not force water, disking, and compacting equipment to deviate from their intended paths.
 - d. Deposit the material over the dump area as a separate and distinct operation. If the material, as deposited, contains an average of more than 1 lump per square yard large enough to have at least one dimension greater than 12 inches, disk the area with at least one pass of a tandem axle disk or two passes of a single axle disk. Use a disk designed and operated to cut and stir to the full depth of the layer.
 3. After depositing and disking (if required), smooth the material to a uniform depth using a suitable motor patrol, bulldozer, or self propelled sheepsfoot type roller with a blade attachment. In addition to the initial smoothing, continue smoothing and leveling during compaction as necessary to provide a surface area free from ruts and other objectionable irregularities. The self propelled, sheepsfoot type roller with blade attachment may be used under the following conditions:
 - a. Leveling is completed according to the prescribed rolling pattern.
 - b. Compaction is the major function of this unit.
 - c. Power drums are prevented from spinning.
 4. When, in the Engineer's opinion, the unit cannot satisfactorily accomplish both leveling and rolling, use a separate dozer or motor patrol for the leveling operation prior to initiation of compaction.

E. Type A Compaction.

1. Type A compaction refers to compaction requiring a **minimum of one rolling per inch depth of each lift**. A further requirement is that the roller continues operation until it is supported on its feet, or the equivalent.
2. After smoothing the surface of the layer and before depositing material for the next layer, compact the layer with at least one pass of the sheepsfoot type roller for each inch of loose thickness of the ~~layer~~ **layers. Compact until the roller is supported entirely on its feet. This occurs when the tamping feet penetrate no more than 3 inches into an 8 inch lift or 33% of the depth of the layer being placed.**
3. Determine if the moisture content of the material is excessive or suitable for satisfactory compaction. The Contractor may elect to start rolling operations immediately after the smoothing operation, or may elect to delay rolling operations, and instead, aerate the material in preparation for rolling. Proceed with aeration and compaction operations in an orderly fashion without unreasonable and unnecessary delay. Rolling operations made prior to any aeration operations for a lift will not be counted as any of the required coverages.
4. Should the material be dry to the extent that it is likely to fail to be satisfactorily compacted by rolling, the Contractor may moisten the material. The Engineer may order the material to be moistened uniformly before compacting. Authorization may be given for the use of water in the final finishing of the roadbed.
5. Compensation will not be allowed for delays occasioned by the ordering of moistening or by drying.
6. **The Contractor may request approval of other methods and equipment according to Article 2107.03, G.** ← See next page

Roller
walk-out

- F. **Type B Compaction.** ← As noted earlier in the specifications, if no type of compaction is required, then Type A is required.
1. Type B compaction refers to compaction requiring a **specified number of diskings and roller coverages**, or the equivalent.
 2. After smoothing the surface of the layer and before depositing the next layer, compact or smooth and compact the layer.
 3. If the entire weight (mass) of the roller is supported on its feet after one pass of the roller for each inch of loose thickness of the layer, no further compacting is necessary. A roller will be considered to be supported entirely on its feet when the feet penetrate no more than 3 inches into an 8 inch lift or 33% of the depth of the layer being placed.
 4. If the soil in the layer is too wet when it is deposited to compact to the degree that the entire weight of the roller is supported on its feet, the Engineer may require one disking per 2 inches of loose thickness of the layer in addition to the disking required in the smoothing operation. A disking consists of a complete coverage of the layer with either a tandem axle disk or a single axle disk. Use a disk designed and operated to cut and stir to the full depth of the layer. The Engineer may require an interval no longer than 2 hours between successive diskings. After the disking has been completed, compact the layer with one pass of a sheepsfoot type roller per inch of loose thickness of the layer.
 5. The manipulation and compaction specified above is incidental to Class 10 or Class 13 excavation. The Engineer may require additional manipulation and compaction as extra work. If the soil is so dry that it will fail to be satisfactorily compacted by rolling, the Engineer may require the Contractor to moisten the material uniformly before it is compacted.
 6. Compensation will not be allowed for delays caused by the ordering of moistening or by disking.
 7. The Contractor may substitute Type A compaction at no additional cost to the Contracting Authority where Type B compaction is specified, by written notification to the Engineer, or the Contractor may request approval of other methods and equipment according to Article 2107.03, G.

G. **Compaction by Other Methods and Equipment.** ← Referenced on bottom of previous page

1. Other methods of compaction may be used. Demonstrate they will obtain suitable compaction of a variety of soil types and moistures normally encountered. **Compaction will be considered suitable if the resulting density, with adequate moisture, is both:**
 - Reasonably uniform throughout the compacted lift.
 - **At least 95% of maximum density**, determined according to Iowa DOT Materials Laboratory Test Method No. Iowa 103.
2. Other types of compacting equipment may be used. Demonstrate they will obtain equivalent compaction results using a variety of soil types and moistures normally encountered. Demonstrations are to be such that results can be compared.
3. For Type A compaction, equivalent compaction must be recognizable by roller penetration or other significant characteristic.
4. For other methods or other equipment, a definite approval will be necessary, including any limitations the Engineer deems advisable.
5. Use of other methods and equipment prior to approval, except for demonstration tests, must provide 6 inch compacted lifts at 95% of maximum density, during which moisture is maintained no drier than 3% below optimum moisture.

H. **Compaction with Moisture and Density Control.**

1. The contract documents will indicate where to construct embankments with moisture and density control. When a specific depth is required, the contract documents will also indicate the distance below the elevation of the completed grading work to which such methods are to be applied.

Here are moisture limits.

Unless specified otherwise in the contract documents, maintain moisture content within the limits of -2.0% and +2.0% of optimum moisture content for maximum dry density.

2. Where construction with moisture and density control is indicated in **cut sections**:
 - a. Excavate the roadbed below proposed subgrade elevation to a plane 6 inches above the elevation shown for the bottom of the moisture and density control section.
 - b. Thoroughly scarify the remaining 6 inch layer.
 - c. Increase or reduce the moisture content as necessary to bring the moisture throughout this 6 inch layer within the moisture limits specified.
 - d. Compact this 6 inch layer to **no less than 90% of maximum density** determined according to Iowa DOT Materials Laboratory Test Method No. Iowa 03.
 - e. **Deposit the remainder of the cut section** to the completed grade elevation in layers **according to Article 2107.03, D.**
 - f. Uniformly moisten each layer as necessary to bring to within the specified moisture limits.
 - g. **Compact each layer to no less than 95% of maximum density.**
3. Where construction with moisture and density control is indicated in embankment sections **outside cuts**:
 - a. Deposit in layers, according to **Article 2107.03, D,** all material in fill above the designated elevation for compaction with moisture and density control.
 - b. Uniformly moisten or dry as necessary to bring each layer **within the specified moisture limits.**
 - c. Compact the **first layer placed with moisture and density control to no less than 90% of maximum** determined according to Iowa DOT Materials Laboratory Test Method No. Iowa 103.
 - d. **Compact each succeeding layer to no less than 95% of maximum density.**
4. Prior to compaction, bring the moisture content of each layer of earth to be compacted with controlled moisture and density to within the specified limits of the optimum moisture content. After field tests determine that a layer is within the specified moisture limits, begin compaction and continue until the required density is obtained. If compaction is interrupted or delayed on a layer, bring the moisture of the layer to within the specified limits before resuming compaction.

This refers to max. 8" loose lifts.

I. **Compaction with Moisture Control.**

Here are moisture limits.

1. The contract documents will indicate where to construct embankments with moisture control. When a specific depth is required, the contract documents will indicate the distance below the elevation of the completed grading work to which such methods are to be applied. **Unless specified otherwise in the contract documents, maintain moisture content within the limits of -2.0% and +2.0% of optimum moisture content for maximum dry density.**
2. Where construction with moisture control is indicated **in cut sections**:
 - a. Excavate the roadbed below proposed subgrade elevation to a plane 6 inches above the elevation shown for the bottom of the moisture control section.
 - b. Thoroughly scarify the remaining 6 inch layer.
 - c. Increase or reduce the moisture content as necessary to bring the moisture throughout this 6 inch layer within the moisture limits specified.
 - d. Compact this 6 inch layer as specified in **Article 2107.03, E.**
 - e. Deposit the remainder of the cut section in layers according to **Article 2107.03, D.**
 - f. Uniformly moisten or dry as necessary to bring each layer within the specified moisture limits.
 - g. Compact each succeeding layer as specified in **Article 2107.03, E.**
3. Where construction with moisture control is indicated in embankment sections **outside cuts**:
 - a. Deposit in layers, according to **Article 2107.03, D,** all material in fill above the designated elevation for compaction with moisture control.
 - b. Uniformly moisten or dry as necessary to bring each layer within the specified moisture limits.
 - c. Compact layers placed with moisture control as specified in **Article 2107.03, E.**
4. Prior to compaction, bring the moisture content of each layer of earth to be compacted with controlled moisture within the specified limits of the optimum moisture content. After field tests determine that a layer is within the specified moisture limits, begin compaction and continue until the requirements of Article 2107.03, E, are obtained. If compaction is interrupted or delayed for more than 1 hour on a layer, bring the layer within the specified moisture limits before resuming compaction.

Max. 8" loose lifts

Type A compaction

J. Rock Fills.

1. When the excavated material consists of rock fragments too large to be placed in layers of the thickness prescribed without further breaking them down, it may be placed in the embankment in horizontal layers 4 feet or less in thickness. Place each layer to avoid future water entrapment. In most cases, this will require placement to full embankment width, except for topsoil on the foreslope. Level each layer with a suitable dozer. Smooth each layer by choking the surface of the rock with spalls and finer fragments or earth.
2. Do not construct the 4 foot lifts above an elevation 2 feet below the finished grade line. The next foot of embankment height may be placed in one layer using rock spalls and finer fragments which may be satisfactorily consolidated by the dozer and tractor. For the last foot below the finished grade line, use either:
 - Earth smoothed and placed in layers not exceeding 8 inches thickness and rolled as described above, or
 - Special backfill material placed as shown in the contract documents.
3. Conduct operations in such a way that the Engineer is given the opportunity to take cross sectional measurements required before the earth cover is placed.

K. Granular Blankets.

1. Where a granular blanket is specified, spread material meeting the requirements of Section 4133 to the width and thickness shown in the contract documents. Do not use compaction equipment. The blanket may be constructed in several lifts. Do not incorporate foreign material from hauling equipment or other sources.
2. In areas requiring both granular blanket and subdrain backfill material, the sequence of operations will be the option of the Contractor. Ensure that contact areas between porous backfill material, granular material for subdrains, and granular blankets are free from clay or silt.

L. Rebuilding Embankments.

1. Do not place a pavement partly on an old and partly on a newly constructed embankment. Remove the part of the old embankment that would be under the pavement as below grade excavation to the natural ground line, or to a depth of 5 feet below the proposed grade line, whichever is higher. Rebuild as prescribed for new embankments.
2. Rebuild embankments according to Article 2107.03, C, unless otherwise specified in the contract documents. Compact the material according to Article 2107.03, E.
3. At locations where the width of embankment widening is less than 4 feet, widening material may be placed and shaped to the bottom of pavement or base elevation without compaction other than that obtained with wheels of motor graders and hauling equipment. Placement and compaction may be accomplished in 8 inch lifts parallel to the finished slope, provided the existing slope has been roughened by diskings or scarification.
4. In all cases of embankment widening, remove surface vegetation from slopes against which the widening material is to be placed. Deposit this material according to Article 2107.03, D.

M. Compacting Trench Bottom.

When designated in the contract documents, excavate the roadbed for the width shown to 1 foot below subgrade elevation. Scarify the next 6 inch depth and compact as for Type B compaction, unless otherwise specified. When the bottom of the trench has been compacted, place suitable backfill material in the excavation and compact. If the type of compaction is not specified for this upper 1 foot, Type A compaction will be required on Primary projects and Type B compaction on Secondary projects.

N. Use of Unsuitable Soils.

1. Unsuitable soils may be used in embankments according to Standard Road Plan EW-102.

2. Unless otherwise specified, when used in embankments, spread unsuitable material in uniform layers no more than 8 inches in loose thickness. Cover each layer with a layer or layers of suitable material.

O. Embankments Adjacent to Culverts and Structures.

1. When the contract documents require embankment construction adjacent to a bridge, culvert, or other structure, construct the compacted embankment to the height shown and to the full width of the roadway. Secure material for constructing these embankments from within the right-of-way or authorized borrow area as directed by the Engineer. Waste the material from within the waterway of bridges or culverts which is too wet to be suitable for compaction. Do not place this material in the embankment.
2. Place embankments adjacent to bridges, culverts, and structures with the same precautions and methods described in Article 2402.03, H. The contract documents may require moisture control.
3. Use mechanical or pneumatic tampers for compaction in areas occupied by embankments which are too narrow for the operation of rollers. The Contractor may elect to enlarge the area in which the embankment is to be constructed by cutting down the elevation of the old fill to permit rolling equipment to operate efficiently. When old fill is removed for this purpose, step it up to its original height such that each step has a horizontal dimension no less than 3 feet with a vertical rise.
4. Flowable mortar may be placed as backfill material adjacent to bridges, culverts, and structures, at no additional cost to the Contracting Authority. Place this backfill material according to Section 2506.

P. Quality Control Program (Embankment Construction).

On projects where the Department is the Contracting Authority:

This gives QC sampling & testing to contractor



1. Provide and maintain a Quality Control Program (Embankment Construction). This is defined as process control sampling, testing, and inspection as described in Materials I.M. 540 for construction of embankments with moisture control, or moisture and density control.
2. Provide a Quality Control Technician who is responsible for all process control sampling, testing, and inspection. The Quality Control Technician shall obtain Soils Technician certification through the Iowa DOT Technical Training and Certification Program (TTCP).
3. Provide a laboratory facility and necessary calibrated equipment to perform required tests.
4. Notify the Engineer when a moisture content falls outside specified control limits or density falls below required minimum. If a moisture content falls outside control limits, fill material in this area will be considered unacceptable for compaction. Perform corrective action(s) to bring uncompacted fill material within control limits. If material has been compacted, disk it, bring to within control limits, and re-compact. When project has a density requirement, if an in-place density does not meet the requirements, compacted fill material in this area will be considered unacceptable. Perform corrective action(s) to material to meet density requirements. Compensation will not be allowed for delays resulting from moistening, diskings, or re-compacting.

2107.04 METHOD OF MEASUREMENT.

A. Measurement will be as provided in Article 2102.04. The following will be included in Class 10 excavation:

1. Excavation in preparation for constructing embankment by compaction with moisture control.
2. Excavation in preparation for constructing embankment by compaction with moisture and density control.
3. Excavation in preparation for compacting trench bottom.
4. Excavation in preparation for rebuilding embankment.

B. Embankment construction will not be measured separately for payment except as follows:

1. Compaction with Moisture and Density Control.

Cubic yards shown on the contract documents as determined by the template fill volume. Shrinkage will not be included in moisture and density control quantity.

2. Compaction with Moisture Control.

- a. Cubic yards shown on the contract documents as determined by the template fill volume. Shrinkage will not be included in moisture control quantity.
- b. When moisture control is required adjacent to culverts and stockpasses (Article 2107.03, O) the volume will be computed using the formula in Article 2107.04, B, 4. When moisture control is required adjacent to pipe culverts, the volume will be computed as provided in Article 2402.04.

3. Compacting Trench Bottom.

Stations shown on the contract documents as determined along the center line of the roadbed.

4. Compacting Backfill Adjacent to Bridges, Culverts, or Structures.

The quantity of backfill material placed and compacted by the grading contractor adjacent to bridges, box culverts, or structures or their extensions will be the quantity obtained by the following formula:

$$Q = \frac{(4 \text{ ft.} \times L \times H)}{27}$$

Where: Q = quantity of compacted backfill material in cubic yards;

L = (1) length in feet of the culvert or stock pass from back to back of parapet, or
(2) length in feet from back of existing parapet to back of parapet of the extension;

H = nominal height of structure opening, feet. If floodable backfill per Standard Road Plan DR-111 is used, H is the height from top of floodable backfill to top of structure.

5. Granular Material for Blanket and Subdrain.

Cubic yards according to Article 2312.04, A.

6. Water for Embankment Construction.

Except when compaction with control of moisture and density or moisture is specified, water for embankment construction required for moistening materials to be placed in embankment will be measured in thousands of gallons by gauging the contents of the transporting vehicle or by metering the supply. Authorized water for finishing the roadbed will not be measured for payment if a period in excess of 2 calendar days has elapsed between final compaction of a dump area and final finishing of the same area.

5 BASIS OF PAYMENT.

Payment for embankment construction will be contract unit price as for Embankment-In-Place according to Article 2102.05, with the following additions:

1. Compaction with Moisture and Density Control.

- a. Per cubic yard.
- b. Payment is full compensation for the work of drying material, furnishing and applying water, controlling moisture content of the materials, and compacting the materials to the specified density.
- c. On projects where the Department is the Contracting Authority, payment includes process control sampling, testing, and inspection.

2. Compaction with Moisture Control.

- a. Per cubic yard.
- b. Payment is full compensation for the work of drying material, furnishing and applying water, controlling moisture content of the materials, and compacting the materials, as specified.

- c. On projects where the Department is the Contracting Authority, payment includes process control sampling, testing, and inspection.
- 3. **Compacting Trench Bottom.**
 - a. Per station.
 - b. Payment is full compensation for the work of scarifying, drying material, furnishing and applying water, controlling moisture content of the materials, and compacting the materials, as specified.
- 4. **Compacting Backfill Adjacent to Bridges, Culverts, or Structures.**

Per cubic yard.
- 5. **Granular Material for Blanket and Subdrain.**

Per cubic yard.
- 6. **Water for Embankment Construction.**
 - a. Except when compaction with moisture and density control or moisture control is specified, payment for water for embankment construction added at the Engineer's direction will be the contract unit price per 1000 gallons.
 - b. In case the contract does not contain a unit price for water, and moistening of the material is authorized or ordered, payment for water will be as extra work at the rate of \$12.00 per 1000 gallons.
 - c. When Type A compaction or compacting embankments with moisture and density control or moisture control is specified, manipulation necessary to incorporate water or work necessary to dry the material will be considered as incidental work and will not be paid for separately.
 - d. When Type B compaction is specified, manipulation necessary to incorporate water will be considered incidental to other work. Work performed at the Engineer's direction to dry or compact the material, in excess of that obtained by the maximum number of diskings and roller coverages specified for Type B compaction, will be paid for as extra work according to Article 1109.03, B.
- B. Payment for Compaction with Moisture and Density Control, Compaction with Moisture Control, Compacting Trench Bottom, and Compacting Backfill Adjacent to Culverts and Stockpasses will be for plan quantities in conjunction with quantities shown in the contract documents described in Article 2102.04 and under the conditions described therein.

STANDARD ROAD PLANS

Place unsuitable soil as detailed for the particular type of soil described in Section 2102 of the Standard Specifications. Project plan details or specific directions of the Engineer may require placement of topsoil or other unsuitable soil by methods other than those shown. Refer also to plan cross sections and soil survey sheets for additional information.

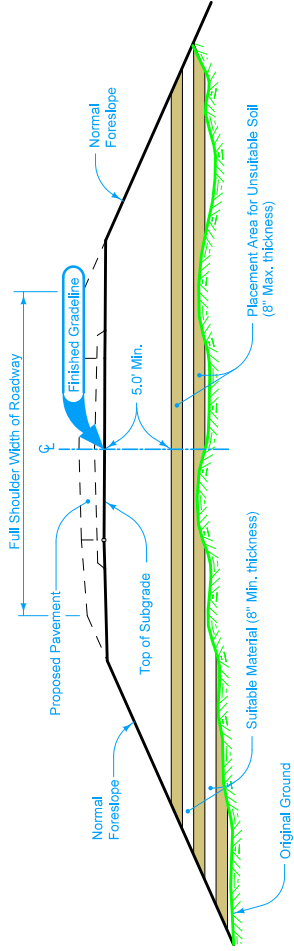

TYPE "A" PLACEMENT

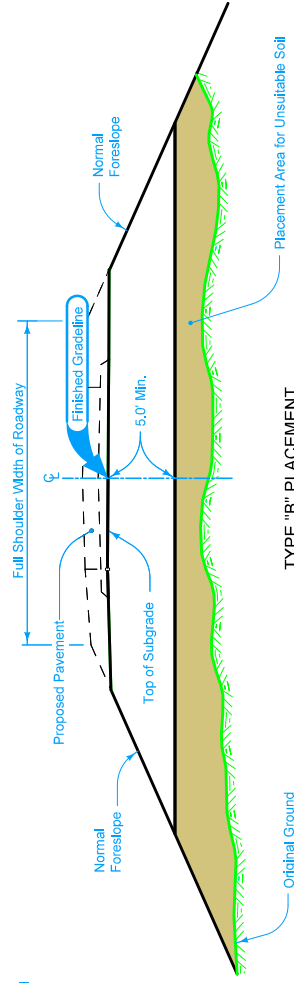

TYPE "B" PLACEMENT

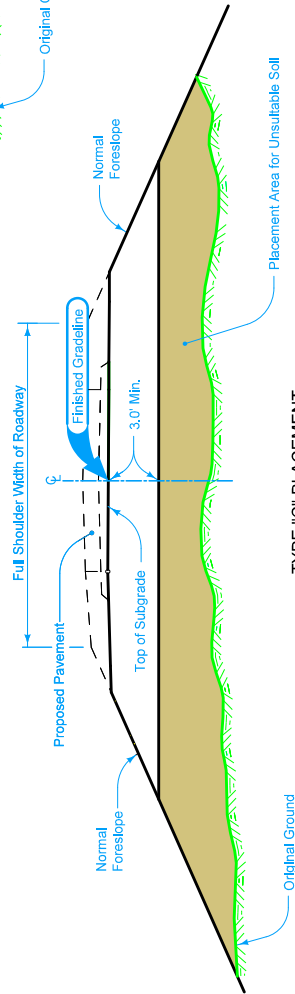

TYPE "C" PLACEMENT

① In new embankments greater than 20 feet in height, only Select, Suitable Class 10, or Type 'C' Unsuitable material will be allowed below that 20 foot depth.

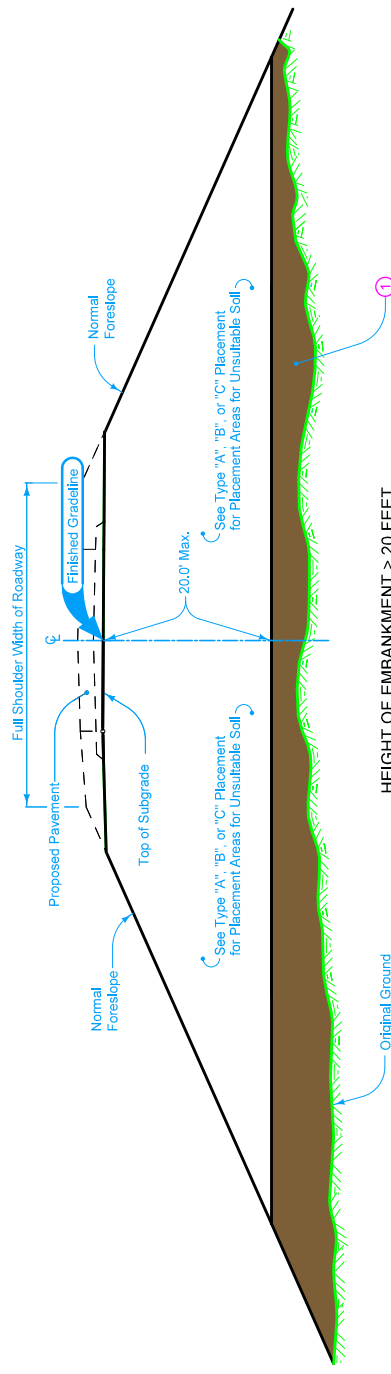

HEIGHT OF EMBANKMENT > 20 FEET

	REVISION	2	10-20-15
	STANDARD ROAD PLAN EW-102		
REVISIONS: Replaced the DOT logo in the title block with the new version.			
APPROVED BY DESIGN METHODS ENGINEER 			
ALLOWABLE PLACEMENT OF UNSUITABLE SOIL IN EMBANKMENTS			

IM 309
PROCTOR DENSITY

DETERMINING STANDARD PROCTOR MOISTURE DENSITY RELATIONSHIP OF SOILS

SCOPE

This test is used to determine the relationship between the moisture content and density of soils or base materials compacted according to a modification of standard procedure, AASHTO T99, Method C. This test method is the field procedure for Laboratory Test Method 103. The sampling procedure to obtain soils used for this test is given in IM 312.

PROCEDURE

A. Apparatus

1. Cylindrical metal mold 4-in. in diameter and 4.584 in. high having a capacity of 1/30 cubic foot with base plate and collar.
2. Scale, capable of weighing at least 5000 grams and sensitive to 0.5 grams
3. Manual compaction device complying with AASHTO T99. Compaction should be performed on a rigid, uniform, and stable concrete foundation or base.
4. A rigid steel straight edge, 9-in. long, with one beveled cutting edge
5. Drying equipment, such as an oven capable of maintaining a temperature of $230^{\circ}\text{F} \pm 9^{\circ}\text{F}$, a microwave, or a hot plate.
6. Mixing equipment. A stainless steel mixing (dish) pan, long handled spoon, rubber or rawhide mallet, putty knife, graduate, and tared weighing scoop
7. Sample extruder, lever or hydraulic type
8. Tared moisture pans

B. Calibration

Check the rammer diameter (2.00 ± 0.01 in.) and the free-dropping-height of the rammer (12.00 ± 0.06 in.) by measurement with a 0.01-in. steel rule. Visually check the condition of the rammer.

1. Check the internal diameter of the mold (4.00 ± 0.02 in.) and the height of the mold (4.58 ± 0.01 in.) with the 0.01-in. steel rule.

C. Sample Preparation

1. Quarter the field sample to a representative sample of about 5000 grams. Spread out and allow to dry to a moisture content at least 5% below the estimated optimum moisture content.
2. Screen the sample over a 3/4-inch sieve and replace the aggregate retained with an equal weight of No. 4 to 3/4 in. aggregate from the same source, or break up the material larger than 3/4" to pass the 3/4" sieve and return it to the sample.

D. Test Procedure

1. Pulverize the prepared sample so that at least 90% of all non-aggregate material will pass the No. 4 sieve. Place the sample in the mixing pan and sprinkle sufficient water to dampen it to approximately 4% below optimum moisture content. The sample is ready for test when, after thorough mixing, a handful of soil squeezed tightly in the palm will barely hold together when pinched between the fingers.
2. Form a specimen by compacting the prepared soil in the mold in three approximately equal layers. Weigh in a tared scoop, and place loose soil in the assembled mold and spread into a layer of uniform thickness. Lightly tamp the soil prior to compaction until it is not in a loose state. Place the mold under the hammer for compaction. Deliver twenty-five uniformly distributed blows. Measure to determine if there is a deviation from the needed 1/3 height in the mold. Adjust the weight of soil taken for the second layer as needed to give the desired height, and compact the same as with the first layer. Following compaction of each of the first two layers, any soil adjacent to the mold walls that has not been compacted or extends above the compacted surface shall be trimmed. Repeat this process for a third layer. During this entire operation, do not allow sample to accumulate on the bottom of the hammer. After compaction of the final layer, the sample should extend 0.1 to 0.4 in. above the height of the mold.
3. Move the mold and contents to a table, remove the collar with a twisting motion and cut off the excess sample in thin layers with the straightedge. If the soil projects more than 0.4 in. above the mold or if the mold is not completely filled, the compactive effort is incorrect and the compacted specimen must be extruded, pulverized, and returned to the mixing pan. After remixing, adjust the weight for each layer as needed and recompact by the same procedure. Replace any small aggregate, which are pulled from the surface with finer hand tamped material. Leave in place large, well-embedded aggregate, and finish the top to arrive at a surface that will average level full.
4. Detach the mold from the base plate and determine the weight of the mold and compacted soil. Extrude the specimen from the mold. Slice vertically through the center of the specimen. Place into a weighted pan at least a 500 gram moisture sample from one of the cut faces. Follow IM 335 to determine moisture content. Pulverize the remaining portion of the specimen and return to the mixing pan.
5. Sprinkle the sample with water, not to exceed 2% of the remaining sample weight, and thoroughly mix until moisture uniformity is reached. The compaction and moisture determination for this moisture content is the same as for the first. Repeat this procedure of adding water, compacting a specimen and taking a moisture sample while increasing the moisture content until a compacted weight is reached that is no more than 20 grams higher

than the preceding one. This signifies that the resultant moisture density curve is past the optimum percent moisture. Since the proctor curve is based on dry density, each 2% moisture increase is the equivalent of approximately 30 grams for a proctor specimen. Thus if the last specimen is only 20 grams heavier than the previous (2% drier) point, this will show a reduced dry density.

E. Calculations

$$\% \text{ Moisture} = \frac{(\text{Wet soil} + \text{pan}) - (\text{Dry soil} + \text{pan})}{(\text{Dry soil} + \text{pan}) - (\text{pan})} (100)$$

Example:

$$\% \text{ Moisture} = \frac{500 - 460}{460 - 170} (100) = 13.8\%$$

$$\text{Wet Density} = \text{Soil mass in proctor mold} \times 0.06614$$

Example:

$$\text{Wet Density} = 1982 \times 0.06614 = 131.1 \text{ pcf}$$

$$\text{Dry Density} = \frac{\text{Wet Density}}{1 + \frac{\% \text{ Moisture}}{100}}$$

Example:

$$\text{Dry Density} = \frac{131.1}{1 + \frac{13.8}{100}} = 115.2 \text{ pcf}$$

F. Moisture-Density Relationship

1. Make the preceding calculations for each compacted specimen at each corresponding moisture content.
2. Using these results, plot points with dry densities (dry weight per cubic foot) as ordinates (vertical) and percent of moisture as abscissas (horizontal).
3. Use the resulting points to draw a smooth curve. The peak of the curve will give the maximum dry density, or Proctor density and the corresponding optimum moisture content. See "Maximum Density Curve".

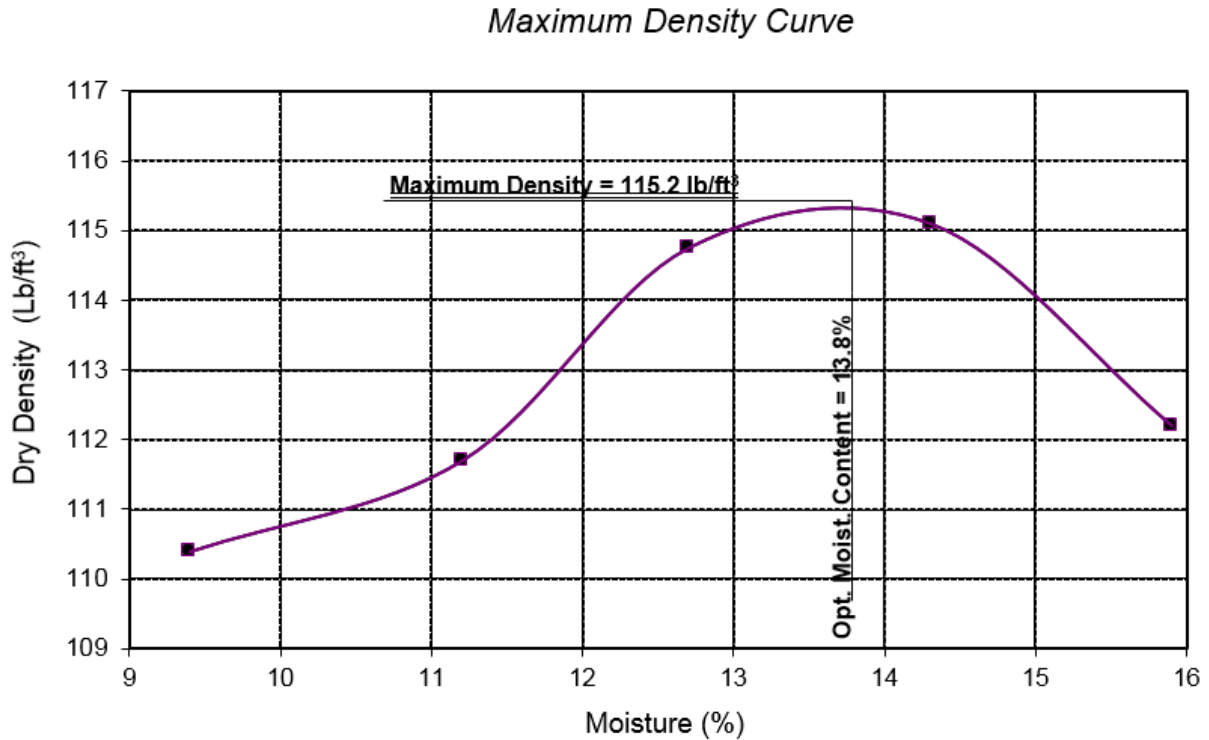

G. One-Point Procedure

1. Grade material other than crushed stone, gravel, black soils, or soils containing a considerable amount of aggregate may be tested for maximum density and optimum moisture according to this procedure. Those excluded above shall be run as in "D", "E", and "F" above.
2. Moisten a representative sample of approximately 3000 grams to an estimated moisture content of zero to three percentage points below Proctor optimum moisture.
3. Following the procedure outlined in D2 through D4, compact and obtain net wet weight of a single specimen at the moisture content in G2. Determine the moisture content and wet density (in pounds per cubic foot) for this single compacted specimen.
4. In the family of curves, plot the point of intersection of the above wet density and moisture. If the plotted point falls outside the "Range of Highest Confidence," recompact another specimen at an adjusted moisture content that will place the plot within these bounds.
5. Using the number of the nearest curve, obtain the Proctor density and optimum moisture values from the attached table.

H. Calculations for One-Point Test

Calculate the moisture content and wet density per E above.

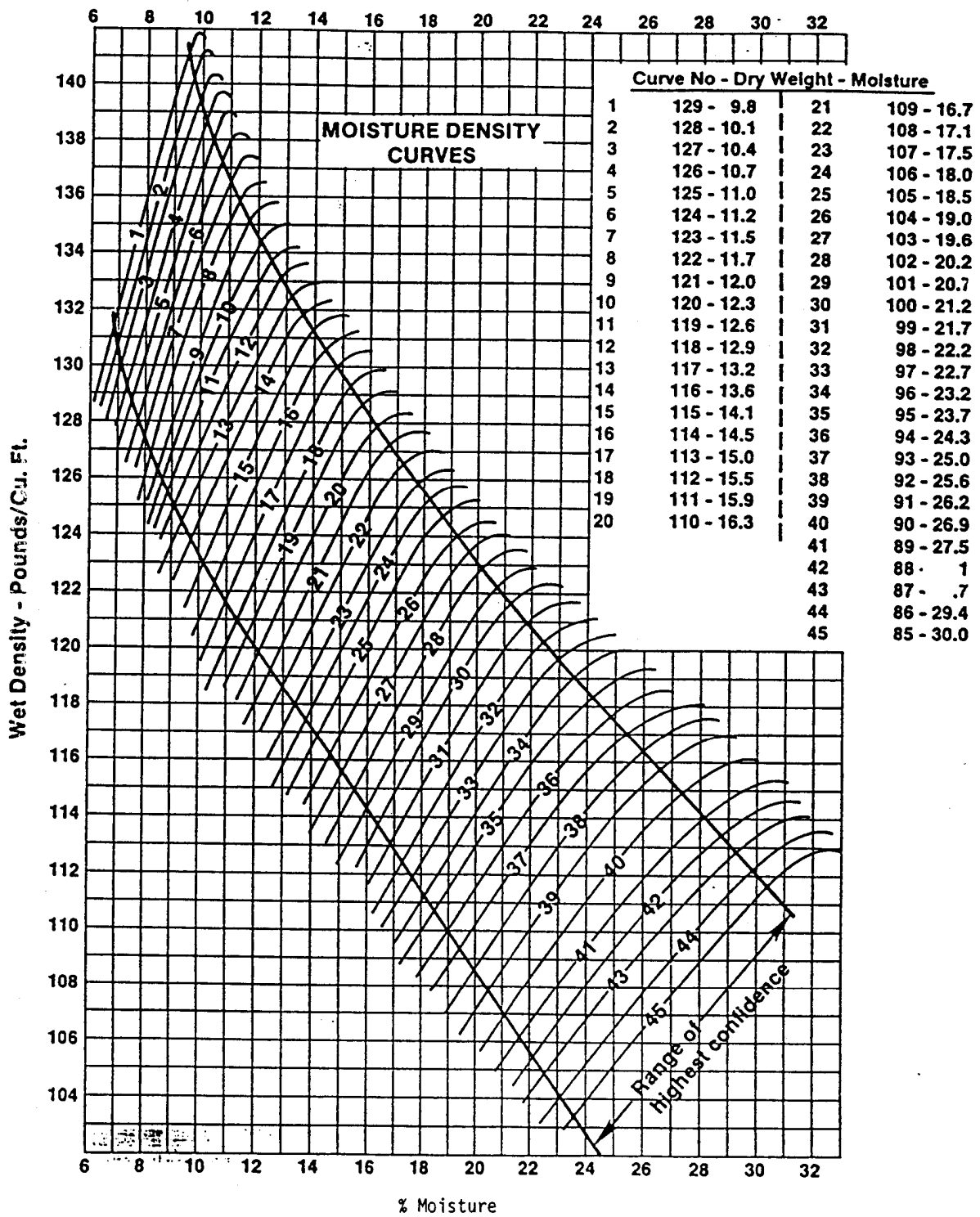

PROCTOR DENSITY CURVES

<u>Curve No.</u>	<u>Dry Density</u>	<u>% Moisture</u>
1	129	9.8
2	128	10.1
3	127	10.4
4	126	10.7
5	125	11.0
6	124	11.2
7	123	11.5
8	122	11.7
9	121	12.0
10	120	12.3
11	119	12.6
12	118	12.9
13	117	13.2
14	116	13.6
15	115	14.1
16	114	14.5
17	113	15.0
18	112	15.5
19	111	15.9
20	110	16.3
21	109	16.7
22	108	17.1
23	107	17.5
24	106	18.0
25	105	18.5
26	104	19.0
27	103	19.6
28	102	20.2
29	101	20.7
30	100	21.2
31	99	21.7
32	98	22.2
33	97	22.7
34	96	23.2
35	95	23.7
36	94	24.3
37	93	25.0
38	92	25.6
39	91	26.2
40	90	26.9
41	89	27.5
42	88	28.1
43	87	28.7
44	86	29.4
45	85	30.0

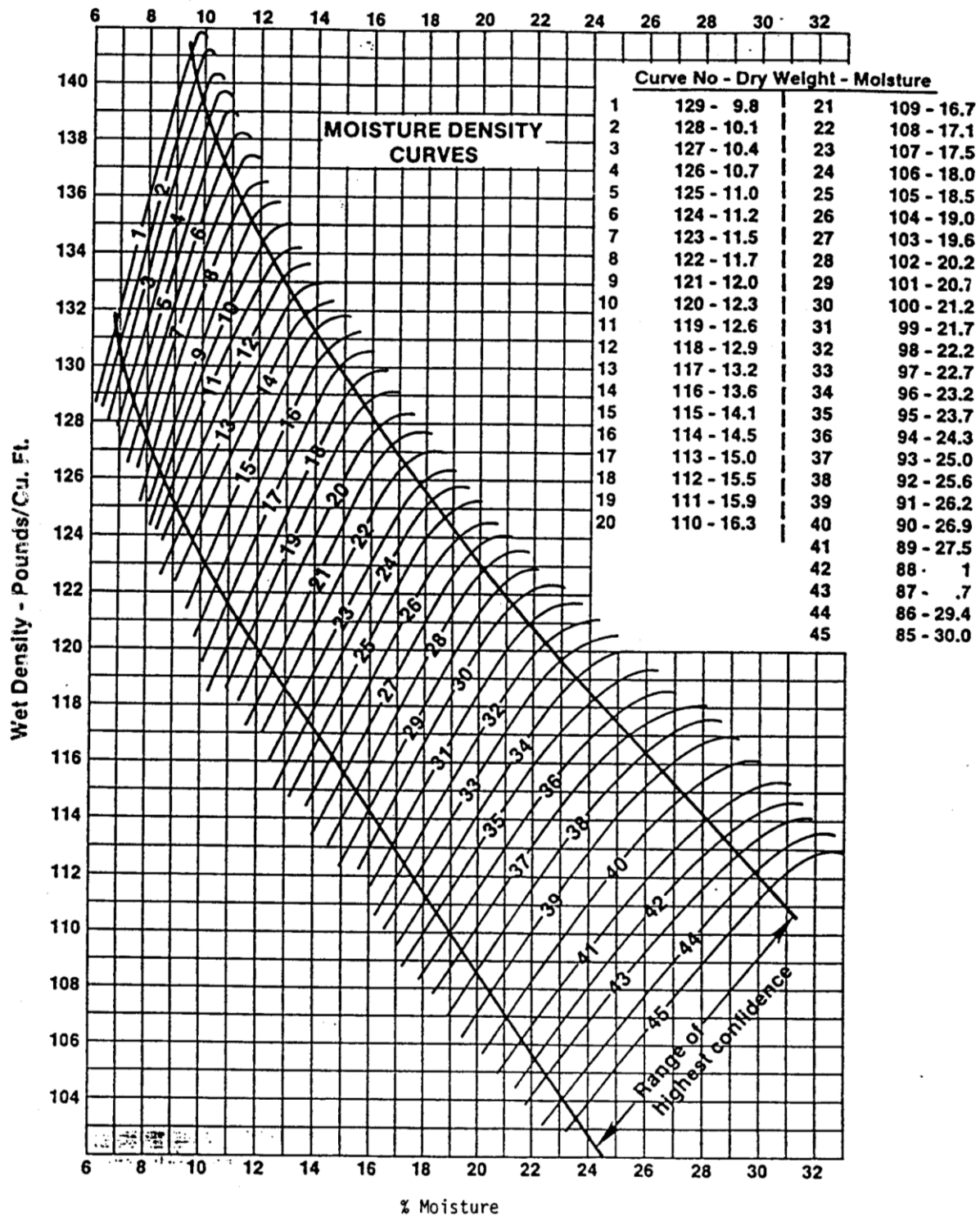

PROCTOR DENSITY CURVES

<u>Curve No.</u>	<u>Dry Density</u>	<u>% Moisture</u>
1	129	9.8
2	128	10.1
3	127	10.4
4	126	10.7
5	125	11.0
6	124	11.2
7	123	11.5
8	122	11.7
9	121	12.0
10	120	12.3
11	119	12.6
12	118	12.9
13	117	13.2
14	116	13.6
15	115	14.1
16	114	14.5
17	113	15.0
18	112	15.5
19	111	15.9
20	110	16.3
21	109	16.7
22	108	17.1
23	107	17.5
24	106	18.0
25	105	18.5
26	104	19.0
27	103	19.6
28	102	20.2
29	101	20.7
30	100	21.2
31	99	21.7
32	98	22.2
33	97	22.7
34	96	23.2
35	95	23.7
36	94	24.3
37	93	25.0
38	92	25.6
39	91	26.2
40	90	26.9
41	89	27.5
42	88	28.1
43	87	28.7
44	86	29.4
45	85	30.0

IM 312
SAMPLING

SAMPLING OF SOILS FOR CONSTRUCTION PROJECT

GENERAL

This method describes the procedure for sampling soils on construction sites. The obtained sample will be used for the proctor test (IM 309), for the measurement of moisture content (IM 335), or nuclear gauge moisture correction (IM 334).

Sampling of Contractor Furnished Borrow is described elsewhere in IM 545.

The intent of sampling is to obtain a suitable amount of soils from the earth with as little disturbance as possible to the natural density, moisture content, and structural arrangement of the particles. A representative sample of soil shall be a combination of the various particles in the same proportion as they exist in the natural ground, roadway or pit. Representative samples should also contain only materials of like color and texture, and should not be a composite of materials apparently different in character.

Soil samples can be collected by using a spade, shovel, or auger, depending on the terrain, the soil type, and the depth of material below the surface.

SAMPLING PROCEDURE FOR THE PROCTOR TEST

The sample consists of a composite of four approximately equal volume samples from select locations within the area under investigation. The recommended minimum sample size is 25 pounds which is sufficient for a four-point test in field.

- Select four representative locations within the sampling area.
- Identify the layer of soils needed to be sampled.
- Remove soils above the sampling layer.
- Take approximately a quarter of the sample from each the selected locations by using a proper tool.
- Place the four obtained samples into a bag or other acceptable container. These samples will be combined into a composite sample.
- Label the sample with a proper ID.

SAMPLING PROCEDURE FOR THE MOISURE TEST

The recommended minimum sample size is 3.0 pounds.

- Select a random location in the sampling area. Sample will be comprised of soil from three locations at this station, the center and the $\frac{1}{4}$ points from each side of the center.
 - Identify the layer of soils needed to be sampled.
 - Remove soils above the sampling layer.
 - Take approximately one-third of the sample from each the selected locations by using a spade or shovel.
 - Composite the soils taken from these three locations.
-

- Before performing the test, reduce the sample size to 1.1 lbs by quartering or other acceptable method.
- Place the obtained sample in a proper bag or container to prevent moisture loss if the test is not immediately performed.
- Label the sample with a proper ID.

Because moisture content may vary significantly over a project site, several samples and tests may be needed in order to obtain more realistic result of moisture content.

IM 335
MOISTURE CONTENT

DETERMINING MOISTURE CONTENT OF SOILS

SCOPE

This method describes several field procedures for determining moisture content of soil. The sampling procedure to obtain soils used for this test is given in IM 312.

PROCEDURE A – DETERMINATION OF MOISTURE CONTENT OF SOIL BY DIRECT HEAT

A. Apparatus

1. Balance having a capacity of at least 5,000 grams accurate to at least 0.1 grams.
2. Direct heat source – hot plate, electric or gas stove or burner, or other heat source. Direct application of heat by open flame to specimen is not appropriate.
3. Containers – suitable container made of material resistant to corrosion and not subject to change in mass or disintegration upon repeated heating, cooling, or cleaning.
4. Miscellaneous (as needed) – Mixing tools such as spatula, spoons, etc. for cutting and stirring the specimen.

B. Preparation of Test Sample

1. Obtain a test sample of at least 500 grams.
2. To avoid moisture loss due to evaporation, the weighing should be done immediately after obtaining the test sample. Also avoid any excessive manipulation of the soil, prior to weighing, which could cause a loss of moisture.

C. Test Procedure

1. Weigh a clean, dry container, and record mass.
2. Place the moisture content sample in the container, and immediately determine and record the mass of soil and container.
3. Apply heat to the soil specimen and container, taking care to avoid localized overheating. Continue heating while stirring and breaking up the specimen to obtain even heat distribution. Continue application of heat until the specimen first appears dry. (Note: A piece of dry, light-weight paper or tissue placed on the surface of the apparently dry soil will curl or ripple if the soil still contains significant water or a mirror will fog up when placed over the sample.)
4. After initial heating period has been completed and soil appears dry, remove the container and soil from the heat source. Determine and record the mass of the soil and container.

-
5. Return the container and soil to the heat source for an additional application of heat.
 6. With a small spatula or knife, continue to carefully stir and mix the soil, taking care not to lose any soil.
 7. Repeat above steps 3 to 6 until the sample has been dried to a constant mass. This is achieved when the change between the two consecutive mass determinations would have an insignificant effect on the calculated moisture content. A change of 0.1% or less of the initial wet mass of the soil should be acceptable for most specimens.
 8. Use the final dry mass determination in calculating water content.

D. Calculation

1. Calculate the moisture content, to the nearest 0.1 percent as follows:

$$\% \text{ Moisture} = \frac{(\text{Wet soil} + \text{pan}) - (\text{Dry soil} + \text{pan})}{(\text{Dry soil} + \text{pan}) - (\text{pan})} (100)$$

PROCEDURE B – DETERMINATION OF MOISTURE CONTENT BY MICROWAVE

A. Apparatus

1. Balance having a capacity of at least 5,000 grams accurate to at least 0.1 grams.
2. Microwave oven.
3. Containers – suitable container made of nonmetallic, nonabsorbent material resistant to thermal shock, and not subject to changes in mass or disintegration upon repeated heating, cooling, or cleaning. Porcelain evaporating dishes and standard borosilicate glass dishes perform satisfactorily.
4. Heat Sink – a material or liquid placed in the microwave to absorb energy and avoid overheating the specimen after the moisture has been driven from test specimen (e.g. glass beaker filled with water).
5. Miscellaneous (as needed) – Mixing tools such as spatula, spoons, etc. for cutting and stirring the test specimen. Glass rods have been found useful for stirring and may be left in specimen container during the testing, reducing the possibility of specimen loss due to adhesion to stirring tool.

B. Preparation of Test Sample

1. Obtain a test sample of at least 500 grams mass.
2. To avoid moisture loss due to evaporation, the weighing should be done immediately after obtaining the test sample. Also avoid any excessive manipulation of the soil, prior to

weighing, which could cause a loss of moisture.

C. Test Procedure

1. Weigh a clean, dry container, and record mass.
2. Place the moisture content sample in the container, and immediately determine and record the mass of soil and container.
3. Place the soil and container in a microwave oven with the heat sink and turn the oven on for 3 minutes. If experience with a particular soil type, specimen size, or microwave oven indicates shorter or longer initial drying times can be used without overheating, the initial and subsequent drying times may be adjusted.
4. After the set time has elapsed, remove the container and soil from the microwave oven. Determine and record the mass of the soil and container.
5. With a small spatula or knife or glass rod, carefully stir and mix the soil, taking care not to lose any soil.
6. Return the container and soil to the microwave oven and reheat for 1 minute.
7. Repeat above steps 4 to 6 until the sample has been dried to a constant mass. This is achieved when the change between the two consecutive mass determinations would have an insignificant effect on the calculated moisture content. A change of 0.1% or less of the initial wet mass of the soil should be acceptable for most specimens.
8. Use the final dry mass determination in calculating water content

D. Calculation

1. Calculate the moisture content, to the nearest 0.1 percent as follows:

$$\% \text{ Moisture} = \frac{(\text{Wet soil} + \text{pan}) - (\text{Dry soil} + \text{pan})}{(\text{Dry soil} + \text{pan}) - (\text{pan})} (100)$$

PROCEDURE C – DETERMINATION OF MOISTURE CONTENT BY DRYING OVEN

A. Apparatus

1. Balance having a capacity of at least 5,000 grams accurate to at least 0.1 grams
2. Drying oven – thermostatically controlled, capable of being heated continuously at a temperature of 230°F ± 9°F (110 °C ± 5°C).
3. Containers – suitable container made of material resistant to corrosion, and not subject to change in mass or disintegration upon repeated heating, cooling, or cleaning.

B. Preparation of Test Sample

1. Obtain a test sample of at least 500 grams.
2. To avoid moisture loss due to evaporation the weighing should be done immediately after obtaining the test sample. Also avoid any excessive manipulation of the soil, prior to weighing, which could cause a loss of moisture.

C. Test Procedure

1. Weigh a clean, dry container, and record mass.
2. Place the moisture content sample in the container, and immediately determine and record the mass of soil and container.
3. Place the soil and container in a drying oven overnight (at least 16 hours).
4. Remove the container and soil from the oven. Determine and record the mass of the soil and container.
5. Use the final dry mass determination in calculating water content.

D. Calculation

1. Calculate the moisture content, to the nearest 0.1 percent as follows:

$$\% \text{ Moisture} = \frac{(\text{Wet soil} + \text{pan}) - (\text{Dry soil} + \text{pan})}{(\text{Dry soil} + \text{pan}) - (\text{pan})} (100)$$

IM 540
QMA - EC

QUALITY MANAGEMENT & ACCEPTANCE - EMBANKMENT CONSTRUCTION

GENERAL

This IM describes the Quality Control Program (Embankment Construction) and quality assurance procedures for soils used in embankment construction that require moisture control or moisture and density control.

QUALITY CONTROL PROGRAM

A. Sampling.

The Contractor shall sample the soil per Materials IM 312.

B. Required Testing.

The Contractor shall use test procedures per Materials IM 204, Appendix A.

1. Proctor.

The Contractor shall determine optimum moisture content and maximum density by Proctor testing for each type of excavated or mixed soil which varies as to change the expected AASHTO classification, or if directed by the Engineer.

With Engineer's approval, and for soils that can be identified during excavation, the Contractor may use the optimum moisture content and maximum density as shown on the soils 'Q' sheets in the contract documents. In lieu of using values from the 'Q' sheets, the Contractor may choose to determine optimum moisture and maximum density from a field sample.

If the Engineer deems the optimum moisture and maximum density of material being excavated and/or mixed is not represented by that shown on the 'Q' sheets, the Contractor shall determine optimum moisture and maximum density from a field sample.

When determined from a field sample at the option of the Contractor or at the Engineer's request, the optimum moisture and maximum density values from the field sample prevail over that shown on the 'Q' sheets.

2. Moisture Content and Density.

The Contractor shall test and verify that moisture content of material placed is within optimum moisture content range and if required, greater than or equal to required minimum density. Upper and lower control limits for field moisture content of embankment material will be shown in the contract documents.

3. Frequency.

The Contractor shall test for proctor optimum moisture content and embankment moisture content and density at minimum frequencies in Materials IM 204, Appendix A.

If source of excavation and moisture have been consistent and within moisture control limits and density has been greater than or equal to minimum density (if required), testing of each lift will be waived for areas less than 1300 cubic yards, or for embankment placed as median dikes or safety dikes. Where testing per lift is waived, the contractor shall test randomly selected samples at a minimum frequency of one test per compacted volume of 1300 cubic yards.

C. Documentation.

The Contractor shall document changes in soil type, fill placement procedures/locations, and test results and submit to the Engineer weekly by uploading to DocExpress.

QUALITY ASSURANCE:

A. Required Testing.

The Contractor shall retain split samples of Proctor testing when requested by the Engineer. The Engineer may select any or all Contractor-retained split samples for verification or independent assurance testing at the minimum frequencies in Materials IM 204, Appendix A.

The Engineer will determine the random location of moisture and (if required) density verification tests and will test at the minimum frequencies in Materials IM 204, Appendix A. The Contractor shall obtain a sample at the same location as directed by the Engineer and provide results to the Engineer. Verification test results will be provided to the Contractor immediately after the Contractor's quality control test results have been reported.

The Engineer will periodically witness field testing being performed by the Contractor. If the Engineer observes quality control field tests are not being performed according to the applicable test procedures, the Engineer may stop production until corrective action is taken. The Engineer will notify the Contractor of observed deficiencies, promptly, both verbally and in writing. The Engineer will document witnessed testing.

B. Acceptability of Test Results.

The Contractor's quality control test results will be validated by the Engineer's verification test results using the criteria in Materials IM 216. If Engineer's verification test results validate the Contractor's test results, the Contractor's results will be used for material acceptance.

In the event that the Contractor's results cannot be validated, Engineer will investigate the reason immediately. Engineer's investigation may include:

- Comparison of Contractor's past and current test results with those of the Engineer,
- Reviewing data and calculations,
- Checking equipment operation, calibrations, and tolerances,
- Observations of Contractor's sampling and testing procedures and
- Testing of other locations or samples.

C. Referee Testing.

If a difference in procedures for sampling and testing and/or test results exists between the Contractor and the Engineer which they cannot resolve, the Iowa DOT's Central Materials Laboratory will provide referee testing. The Engineer and Contractor will abide by results of referee testing.

ACCEPTANCE

The Engineer will base final acceptance of tests and materials on results of the Contractor's quality control testing as validated by Engineer's quality assurance.

Personnel and laboratories performing tests used in acceptance of material shall participate in the Quality Assurance Program covered in Materials IM 205.

**IM 204 (A) FREQ.
& IM 208 LAB QUAL**

IM 204

Appendix A

Sampling & Testing Guide-Minimum Frequency

ROADWAY & BORROW EXCAVATION & EMBANKMENTS

April 19, 2022
Supersedes October 15, 2019

Sections 2102, 2107, 2109 & 2432

Matls. IM 204
Appendix A (US) Units

MATERIAL OR CONSTRUCTION ITEM	TESTS	METHOD OF ACCEPTANCE & RELATED IMS	QUALITY CONTROL				INDEPENDENT ASSURANCE & VERIFICATION S&T				REMARKS				
			SAMPLE BY	FREQ.	SAMPLE SIZE	TEST BY	REPORT	S&T TYPE	SAMPLE BY	FREQ.		SAMPLE SIZE	TEST BY	REPORT	
SOURCE INSPECTION															
Special Backfill, Crushed Stone (4132.02), Gravel (4132.03)		AS													
			209												
				209,210											
		Quality	AS	209											
Crushed Concrete (4132.02), RAP (2303.02)															
		Quality	AS	496.01											
Granular Backfill (4133.4134)															
		Quality	AS	545	IM 545	CONTR	IM 545 & Cert	V	RCE/ CONTR	1/10 QC tests	35 lb.	CTRL	Test Report		
Engr. Fabric (4196)															
Contractor Furnished Borrow															
GRADE INSPECTION															
Moisture Control, (QC by Contractor) Note 1	Proctor		309	CONTR	1/ soil class	25 lb	CONTR	Field Book & Test Report	V (7)	CONTR/ RCE	1/10 req'd QC tests (min. 1)(5) 1/proj.	25 lb.	RCE/ DME CTRL/ DME	Field Book Test Report	Note 8
	Moisture		335, 334	CONTR	1/ft/1500 ft (for max of 1300 cy) (6)	3 lb	CONTR	Field Book & Test Report	V (7)	RCE (2) DME	1/10 req'd QC tests (min. 1)(5) Witness 1/proj.	3 lb.	RCE	Field Book	Note 8
Moisture & Density Control, including Special Compaction of Subgrade (2109.03C), (QC by Contractor) Note 1	Proctor		309	CONTR	1/ soil class	25 lb	CONTR	Field Book & Test Report	V (7)	CONTR/ RCE	1/10 req'd QC tests (min. 1)(5) 1/proj.	25 lb.	RCE/ DME CTRL/ DME	Field Book Test Report	Note 8
	Moisture		335, 334	CONTR	1/ft/1500 ft (for max of 1300 cy) (6)	3 lb	CONTR	Field Book & Test Report	V (7)	RCE (2) DME	1/10 req'd QC tests (min. 1)(5) Witness 1/proj.	3 lb.	RCE	Field Book	Note 8
AS-Approved Source ASD-Approved Shop Drawing S&T-Sampling & Testing	In-place Density	326 & 334, ASTM D2937, D2167, D1556, D8167 (3) AASHTO T191 & T233		CONTR	1/ft/1500 ft (for max of 1300 cy) (6)	As req'd by test	CONTR	Field Book & Test Report	V (7)	RCE/ DME DME	1/10 req'd QC tests (min. 1)(5) Witness 1/proj.		RCE/ DME	Field Book	Note 8

Cert- Certification Statement
RCE-Resident Construction Engineer/Project Engineer
DME-District Materials Engineer
CTRL-Central Laboratory
CONTR-Contractor
IA-Independent Assurance
V-Verification

Note 1: When Contractor QC testing is not required in the contact documents. The RCE will perform verification testing at the frequency listed for QC.
 Note 2: RCE will direct the Contractor to take a moisture sample beside the RCE verification sample location.
 Note 3: Low activity nuclear gauge, such as Troxler EGauge, is approved for use for wet density only. Location for testing shall be as described in IM 334, and moisture content determined per IM 335.
 Note 4: For earthwork quantities of less than 50,000 Yd³, no IA will be required.
 Note 5: If no QC tests are required, then no verification or independent assurance tests are required.
 Note 6: If source of excavation and moisture have been consistent and within moisture control limits and density has been greater than or equal to minimum density (if required), testing of each lift will be waived. Minimum frequency will be 1 per 1300 Yd³.
 Note 7: For earthwork quantities of less than 1300 Yd³, no verification tests will be required.
 Note 8: For Local agency projects not receiving Federal funding, Independent Assurance, IA, tests are not required.

April 19, 2022

ROADWAY & BORROW EXCAVATION & EMBANKMENTS

Matls. IM 204

Supersedes October 15, 2019

Sections 2102, 2107, 2109 & 2432

Appendix A (US) Units

Sampling & Testing Guide-Minimum Frequency

MATERIAL OR CONSTRUCTION ITEM	TESTS	METHOD OF ACCEPTANCE & RELATED IMs	QUALITY CONTROL				INDEPENDENT ASSURANCE & VERIFICATION S&T				REMARKS		
			SAMPLE BY	FREQ.	SAMPLE SIZE	TEST BY	REPORT	S&T TYPE	SAMPLE BY	FREQ.		SAMPLE SIZE	TEST BY
GRADE INSPECTION Moisture & Density Control of MSE wall backfill	Proctor	309	CONTR	1/ source	25 lb	CONTR	Field Book & Test Report						
	Moisture	335, 334	CONTR	1/lift (for max of 250 cy) (1)	3 lb	CONTR	Field Book & Test Report	V	RCE				Note 3
	In-place Density	326 & 334 ASTM D2937, D2167, D1556, D8167 (4) AASHTO T191 & T233	CONTR	1/lift (for max of 250 cy) (1)	As req'd by test	CONTR	Field Book & Test Report	IA (2) V	DME RCE	1/proj. Witness 1/10 req'd QC tests		DME	
AS-Approved Source ASD-Approved Shop Drawing S&T-Sampling & Testing	Cert- Certification Statement		RCE-Resident Construction Engineer/Project Engineer DME-District Materials Engineer CTRL-Central Laboratory CONTR-Contractor				IA-Independent Assurance V-Verification						

Note 1: If source of excavation and moisture have been consistent and within moisture control limits and density has been greater than or equal to minimum density (if required), testing of each lift will be waived. Minimum frequency will be 1 per 250 Yd³.

Note 2: For MSE wall backfill quantities of less than 50,000 Yd³, no IA will be required.

Note 3: For Local agency projects not receiving Federal funding, Independent Assurance, IA, tests are not required

Note 4: Low activity nuclear gauge, such as Troxler EGauge, is approved for use for wet density only. Location for testing shall be as described in IM 334, and moisture content determined per IM 335.

IM 208

MATERIALS LABORATORY QUALIFICATION PROGRAM

GENERAL

The FHWA has outlined a Laboratory Qualification Program in the Federal-Aid Policy Guide update published as 23 CFR 637 on June 29, 1995. The updated guide has requirements for laboratories performing testing on Federal-Aid highway projects.

In order to avoid an appearance of a conflict of interest, any qualified non-DOT laboratory shall perform only one of the following types of testing on the same project: Verification testing, quality control testing, IA testing, or dispute resolution testing.

LABORATORIES TO BE QUALIFIED

The following laboratories are included in the qualification program for all Federal-Aid projects:

Central Materials Laboratory	Ready Mix Laboratories
6 District Laboratories	PCC Contractor Laboratories
District Area Laboratories	HMA Contractor Laboratories
Resident Construction Laboratories*	Consultant and Commercial Laboratories *
Aggregate Producer Laboratories	City and County Laboratories *
Soils Field Laboratories*	

* May be qualified at the time of a project.

LABORATORY QUALIFICATION PROCESS

A two-level qualification system is required by the FHWA. Laboratories are either accredited or qualified. The accreditation process is more rigorous than the qualification process.

Accredited Laboratory Process

The Central Materials Laboratory and the six District Laboratories will be accredited as outlined in the 23 CFR 637 guide. The Central Materials Laboratory is accredited through the AASHTO Materials Reference Laboratory Program. The District Materials Laboratories will be accredited by using the Central Materials Staff and equipment to check testing and testing procedures and by using the same calibration and training documentation process. Laboratories will be accredited for a two-year period. In addition, an annual review will be made by the Central Office Staff. [Appendix A](#) contains the procedures for accrediting the District Materials Laboratories.

Qualified Laboratory Process

The remaining laboratories will be qualified as outlined below:

The District Materials Offices will qualify laboratories. Laboratories will be qualified for a two-year period. In addition, an annual review will be made by District Staff. [Appendix B](#) contains the procedures for qualifying materials laboratories.

Four laboratory types will be qualified, aggregate laboratories, PC Concrete laboratories, soils field laboratories, and Hot Mix Asphalt laboratories.

Qualified laboratories will have the following:

1. Current manuals and test methods to perform the qualified testing available
2. A technician certified by the Iowa DOT to perform the qualified testing
3. Proper equipment to perform the qualified testing (calibrated or checked annually according to [Appendix B](#))
4. Satisfactory project and proficiency test results
5. Documentation of equipment calibrations, equipment checks, and proficiency results

The District may elect to accept qualifications, accreditations, or inspections from other government agencies or Laboratory inspection agencies. The AASHTO Materials Reference Laboratory (AMRL) and Cement and Concrete Reference Laboratory are 2 common Laboratory inspection programs. The links are:

<http://aashtoresource.org/>

<http://www.ccril.us/Lip/LabListReport.pdf>

Accredited Laboratories for Testing Soil Samples for Contractor Borrow

Laboratories for testing soil samples for contractor borrow shall be accredited for performing the following tests:

- Atterberg Limits (AASHTO T89 and T90, or ASTM D4318)
- Percent gravel, sand, silt, and clay (AASHTO T88 or ASTM D422)
- Proctor density and optimum moisture (AASHTO T99, ASTM D698)
- Hydrometer particle size analysis of soils (AASHTO T88 or ASTM D422)

The accreditation could be AMRL, A2LA, Army Corp of Engineers, or other acceptable accreditation program.

ADMINISTRATION OF THE PROCESS

The Central Materials Laboratory will be responsible for implementation and operation of the Laboratory Qualification Program. The Central Materials Laboratory will accredit the District Laboratories. The District Materials Offices will qualify laboratories.

NON-COMPLIANCE/DISPUTE RESOLUTION

A laboratory that does not meet the requirements of the IM is subject to elimination from the qualification program.

Disputes concerning calibration and correlation of equipment will be resolved by the office responsible for the qualification. For disputes that cannot be resolved at the District, the Central Materials Laboratory will be the final authority.

LABORATORY QUALIFICATION PROGRAM

The District Materials Office will qualify the other laboratories and maintain records of the qualification for three years. The District Staff will check the following prior to qualifying a laboratory:

1. Establish the type of laboratory (Aggregate, Hot Mix Asphalt, Soils Field, PC Concrete).
2. Check for current manuals and test procedures covering the qualified testing.
3. Check the certification of the testing personnel.
4. Document that proper equipment is available to perform qualified testing.
5. Check documentation system.

Scheduling of the qualification review will be discussed with the laboratories seeking qualification. The District staff performing the qualification review should have the appropriate certification ([IM 213](#)) for the type of laboratory and tests being reviewed. The District Materials Engineer should be contacted for laboratories that have been qualified in other states. The District Materials Office may qualify a laboratory based on an acceptable qualification report and qualification program from another state transportation agency.

Table 1 and the pages following cover the list of items to be reviewed.

An oral close out on any deficiencies will be held with the testing personnel. Written notice will be sent within two weeks of the inspection. District personnel will re-inspect after correction of any deficiencies.

A form showing the laboratory type, the date qualified, and the expiration date will be issued by the District Materials Engineer.

NON-COMPLIANCE/DISPUTE RESOLUTION

A laboratory that does not meet the requirements of the IM is subject to elimination from the qualification program.

The office responsible for the qualification will resolve disputes concerning calibration and correlation of equipment. For disputes that cannot be resolved at the District level, the Central Materials Laboratory will be the final authority.

Table 1 - Laboratory Qualification Checklist

	√	Calib./Verif. Interval	Calib./Verif. Procedure
Tester Qualifications-Proper Iowa DOT certifications			
Current Test Procedures			
Current Calibration Procedures & Records			
Documentation of correlation results and corrective actions taken for previous construction season.			

Soils Field Laboratory			
Balances		12 months	(b)
Sieves- wear, tear, size		12 months	
Mold, Base, and rammer condition		(a)	IM 309
Aggregate Laboratory			
Balances		12 months	(b)
Sieves- wear, tear, size, and opening size		12 months	Iowa 1506
Splitter- condition		12 months	(Visual)
Mechanical Shakers- condition (if used)		12 months	Iowa 1502
HMA Laboratory			
Balances- and water bath		12 months	(b)
Sieves- wear, tear, size, and opening size		12 months	Iowa 1506
Splitter- condition		12 months	(Visual)
Mechanical Shakers- condition (if used)		12 months	Iowa 1502
Rice equipment- vacuum and flask		12 months	IM 350
Thermometers		12 months	Iowa 1607
Ovens- temperatures		12 months	Iowa 1501
Gyratory Compactor and molds		12 months	Iowa 1522
PCC Laboratory			
Balances		12 months	(b)
Sieves- wear, tear, size, and opening size		12 months	Iowa 1506
Splitter- condition		12 months	(Visual)
Mechanical Shakers- condition (if used)		12 months	Iowa 1502
Air Meter		12 months	IM 318
Slump Cone and equipment-condition		12 months	
Flexural Strength Apparatus		12 months	Central Lab
(a) The mold, base or rammer should be checked if the condition warrants.			
(b) For checking the calibration either use the scale calibration firm's procedure or Iowa 917.			

LABORATORY ITEMS

PCC Portable Paving Plant

The following list contains, as a minimum, what is required for a qualified PCC paving plant laboratory. The test equipment to perform each of the required tests is contained in the respective IM.

- Field Lab of suitable size for workspace, space to perform tests, and sample storage. Locate the Field Lab so it is convenient to the plant, but outside the influence of plant vibration.

Air-conditioned
 Personal computer
 Phone
 All in one printer



Soils Field Laboratory Inspection Quality Control Checklist

Contractor/Producer: _____ Location: _____
Certified Technician: _____ Certification No.: _____

Balances (Iowa Test Method 917)

	Yes	No
Updated balance calibration records available?	<input type="checkbox"/>	<input type="checkbox"/>
Check balance using 500 gm & 1000 gm calibrated weights?	<input type="checkbox"/>	<input type="checkbox"/>
Is balance accurate to 0.1%?	<input type="checkbox"/>	<input type="checkbox"/>

Sieves

Are the sieves in good condition (no loose frames, holes, or tears)? Yes No

Mold, Base, and Rammer (AASHTO T99)

Are they in good condition? Mold round and the base flat? Yes No
If not, check the dimensions for out-of-tolerance.

Rigid Foundation

Do they have a concrete pad or floor or other rigid foundation to compact the specimen on? Yes No

Comments:

cc: Materials Engineer
Contractor/Producer
Ames
File

Inspected by: _____

Date inspected: _____

**IM 213 (D) DUTIES
& IM 216 TOLER.**

IM 213

Appendix D

SOILS TECHNICIAN DUTIES

A certified Soils Technician is required for all projects with Compaction with Moisture Control, Compaction with Moisture and Density Control, or Special Compaction of Subgrade (including for Recreation Trails). Refer to contract documents for Contractor QC testing requirements. Duties of the Soils Technician consist of, but are not limited to the following:

- A. Sampling: Obtain samples at required frequencies per [IM 204](#).
 - B. Proctor Testing
 - C. Other Testing as Required
 - 1. For projects with Compaction with Moisture Control: Determine moisture content per frequencies in [IM 204](#).
 - 2. For projects with Compaction with Moisture and Density Control or Special Compaction of Subgrade: Determine moisture content and in-place density per frequencies in [IM 204](#).
 - D. Sampling & Testing Equipment
 - 1. Clean and check testing sieves for defects.
 - 2. Assure scale accuracy.
 - 3. Check and maintain other testing equipment.
 - E. Evaluate the test data.
 - 1. For projects with Compaction with Moisture Control: Confirm soils are being placed within required moisture content range.
 - 2. For projects with Compaction with Moisture and Density Control or Special Compaction of Subgrade: Confirm soils are being placed within required moisture content range and soil is compacted to density equal to or greater than density requirement.
 - F. Documentation and Communication
 - 1. Document test data. A copy is sent to the Project Engineer.
 - 2. Relay test results to appropriate supervisory personnel.
 - 3. Notify the Project Engineer if any test results do not meet contract requirements and assure corrective actions are taken.
-

IM 216

GUIDELINES FOR DETERMINING THE ACCEPTABILITY OF TEST RESULTS

GENERAL

Criteria for determining the acceptability of test results is an integral part of the Quality Assurance Program. The comparison between two different operator's results is used in the independent assurance program and sometimes in the validation process. The tolerances in this IM are for comparing individual test results except in the case of the profile index where averages are used. When criteria for comparing test results is not established in this IM or any other IM, use of the AASHTO or ASTM test procedure precision criteria is appropriate for determining acceptability of test results.

When the tolerances are exceeded, an immediate investigation must be made to determine possible cause so that any necessary corrections can be made. Below are some steps that may be used to identify the possible cause:

1. Check all numbers and calculations.
2. Review past proficiency and validation data.
3. Review sampling and testing procedures.
4. Check equipment operation, calibrations and tolerances.
5. Perform tests on split samples or reference samples.
6. Involve the Central Materials Laboratory.

TOLERANCES

<u>TEST NAME</u>	<u>TEST METHOD</u>	<u>TOLERANCE</u>
Slump of PC Concrete 1" or less on IA or Verification More than 1" on IA or Verification	IM 317	1/4 in. 3/4 in.
Air Content of PC Concrete	IM 318	0.4% 0.5% for air >8%
Length of Concrete Cores	IM 347	0.10 in.)
NDT Pavement Thickness (MIT)		<=0.15 in.
Free Moisture in Aggregate, by Pycnometer	IM 308	0.2%
Specific Gravity of Aggregate, by Pycnometer	IM 307	0.02
Moisture in Aggregate, by Hot Plate		0.3%
Moisture in Soil	IM 335 , IM 334	1.5%
Proctor Optimum Moisture Content	IM 309	2.0%
Proctor Maximum Dry Density	IM 309	5.0 lb./ft ³

In-Place Wet Density, Soils & Bases	IM 334, 326, other approved	2.0 lb./ft ³
G _{mm} Maximum Specific Gravity	IM 350	0.010
G _{mb} Density of HMA Concrete, by Displacement	IM 321	0.020
G*/Sin Delta	T315	17% of mean
% Binder, Ignition Oven	IM 338	0.33%
G _{sa} Apparent Specific Gravity	IM 380	0.010
G _{sb} Bulk Specific Gravity	IM 380	0.028
Percent Absorption	IM 380	0.37%
Fine Aggregate Angularity	T304	2.0%
Sand Equivalency	T176	10 % of mean
Pavement Profile Index (0.2" blanking band) Verification Profile Index Test Result <u>Inches/mile</u> 6.0 or less 6.1 to 20.0 20.1 to 40.0 More than 40.0	IM 341	1.0 in./mi. 2.0 in./mi. 3.0 in./mi. 5.0 in./mi.
Pavement Profile Index (0.0" blanking band) Verification Profile Index Test Result <u>Inches/mile</u> 25.0 or less 25.1 to 40.0 More than 40.0	IM 341	3.0 in./mi. 4.0 in./mi. 5.0 in./mi.
Bridge Profile Index (0.2" blanking band) Verification Profile Index Test Result <u>Inches/mile</u> 6.0 or less 6.1 to 20.0 20.1 to 40.0 More than 40.0	IM 341	2.0 in./mi. 3.0 in./mi. 4.0 in./mi. 6.0 in./mi.
Pavement International Roughness Index (IRI) Verification IRI Test Result <u>Inches/mile</u> 50.0 or less 50.1 to 150.0	IM 341	10.0% of mean 8.0% of mean

IM 334
NUCLEAR GAUGE

**DETERMINING MOISTURE CONTENT & DENSITY OF SOILS,
BASES & SUBBASES WITH A NUCLEAR GAUGE**

SCOPE

This test method describes the procedure used in determining the in-place density and moisture content of soils, cold-in-place recycled asphalt pavement, soil aggregate sub-base, soil lime sub-base, and cement treated granular base or sub-base by the use of nuclear method.

OPERATOR QUALIFICATION

In addition to complying with IM 206 (as applicable), an operator, to determine the moisture content and density of soils, bases, and sub-bases with a nuclear gauge, must first demonstrate knowledge and proficiency in various related areas that may affect the test result. The specific areas will be determined by and demonstrated to the satisfaction of the District Materials Engineer or an authorized representative.

PROCEDURE

A. Apparatus

1. A recognized nuclear moisture-density gauge containing a radioisotope, detectors and related circuitry. The gauge shall be capable of determining densities by either the backscatter or direct transmission methods.
2. A reference standard for the purpose of taking standard counts, and for checking equipment operation.
3. A drill rod and combination guide-scraper plate for preparing the testing site.
4. Manufacturer Instructional Manual.

B. Standard Counts

1. Place the reference standard in a position recommended by the manufacturer to obtain standard counts.
2. Allow the gauge to warm up as suggested by the manufacturer.
3. Take one automatic four-minute standard count per manufacturer instructions. This count should be within 1% of the latest standard count established for the gauge. In the event the standard count varies by more than 1%, make a note of that number, reject that count on the gauge and then obtain another standard count. The two standard count numbers just obtained should be within 1% of each other and within 2% of the latest established standard count. If so, retain and record the last standard count taken.
4. If the day-to-day shift in the standard count varies more than 2% for moisture or 1% for density, reset the gauge on the standard and repeat the procedure in B3.
5. Keep a log of the gauge standard counts.

-
6. Standard counts should be taken twice a day to detect any shift during daily use.

C. Site Preparation

1. Select a random location in the testing area. Test will be run at three locations at this station, the center and the $\frac{1}{4}$ points from each side of the center. Moisture and density determinations will be based on the average of the readings from the three locations. Test locations should be such that the gauge will be a least 6 in. away from any vertical projection. Be sure the vehicle is at least 10 ft. away from the test site.
2. Remove all loose and disturbed material, and remove additional material as necessary to reach the top of the compacted lift to be tested.
3. Prepare a horizontal area, sufficient in size to accommodate the gauge, using the scraper plate supplied with the gauge; by planing to a smooth condition so as to obtain maximum contact between the gauge and material being tested. Make sure the gauge sits solidly on the site without rocking.
4. The maximum depressions beneath the gauge shall not exceed $\frac{1}{8}$ in. Use native fines or fine sand to fill voids and level the excess with the scraper plate. The total area thus filled with native fines or sand should not exceed ten percent of the bottom area of the gauge.

D. Moisture Determination

1. Prepare test site as described in C.
2. Obtain a one-minute moisture count.
3. The moisture measurement is based upon the thermalization of fast neutrons by hydrogen atoms. Because some materials may contain hydrogen other than free water or may contain thermalizing elements other than hydrogen, the moisture content value should be verified by comparison with Materials IM 335. If the moisture differential between the two tests is greater than 1.5%, then not less than four moisture samples should be oven dried to determine the moisture correction factor. Refer to gauge manufacturer instructions for correcting gauge-derived moisture content values. Typically, if the gauge reading is higher than the values obtained by oven dry samples, the error is due to hydrogen containing materials. If the gauge reading is lower than that obtained by oven drying, the error is likely due to materials which absorb thermalized neutrons. Note: Moisture correction is not typically required for embankment materials.

E. Density Determination - Direct Transmission

1. Place the guide plate on the site for the moisture determination and drive the drive pin through the guide to a depth at least 2 in. below the depth of material to be measured. Remove the drive pin by pulling straight up in order to avoid disturbing the access hole.
2. Place the gauge over the access hole and push the index handle down until the source has reached the desired depth.
3. With the source at the desired depth, pull the gauge so that the probe is in contact with the

near side of the hole, take and record a one-minute wet density count.

4. Generally no corrections for density need be made due to soil compositional error, however, if a soil has a mean atomic weight higher than limestone, the gauge may indicate a high density. If it is felt that the gauge is indicating an unrealistic high density, two undisturbed soil cores shall be obtained. These two cores should be sent to the Central Materials Laboratory and be tested for density using Iowa Test Method 102. A correction factor should be obtained based on the density measured by the Central Materials Laboratory. This factor should be applied to the field nuclear densities.

F. Calculations

When determining the moisture correction described in D3, refer to gauge manufacturer's instructions for moisture correction calculations.

G. General Notes

1. Do not attempt to operate a nuclear gauge before thoroughly reading the Instruction Manual.
2. Do not attempt to operate a nuclear gauge before thoroughly reviewing the radiological safety precautions described in IM 206, "Nuclear Test Equipment."

DOCUMENTATION

Links for various forms:

E107 Field Moisture Test

www.iowadot.gov/Construction_Materials/inspection_tools/Grading/E107_Field_Moisture_Test.xlsx

www.iowadot.gov/Construction_Materials/inspection_tools/Grading/E107%20Field%20Moisture%20Test.pdf

E108 Proctor Tests

www.iowadot.gov/Construction_Materials/inspection_tools/Grading/E108_Proctor_Test.xlsx

Form 821258 Nuclear Test Report

<https://forms.iowadot.gov/FormsMgt/External/821258.pdf>

Proctor Density Calculation Spreadsheet

www.iowadot.gov/Construction_Materials/earthwork_erosion/Proctor%20Density%20Calculation%20Sheet.xlsx

Random Sampling Worksheet

www.iowadot.gov/Construction_Materials/earthwork_erosion/Embankment_random_sample_locations.xlsx

2014

Construction and Materials Review

Roadway & Borrow Excavations and Embankments

Project No.: 0

Contract No.: 0

Refer to IM 204, Appendix A

Job Control Tests (Construction)

<u>Contract Item No.</u>			<u>Required</u>	<u>Documented</u>
<u> </u>	Q/C Proctor Tests	1 / soil class	<u> </u>	<u> </u>
<u> </u>	Verification Proctor Tests	1 / 10 req'd QC tests	<u> </u>	<u> </u>
<u> </u>	Q/C Moisture Tests	1 / lift / 1500 ft (for max 1300 cy)	<u> </u>	<u> </u>
<u> </u>	Verification Moisture Tests	1 / 10 req'd QC tests	<u> </u>	<u> </u>
<u> </u>	Q/C In-Place Density Tests	1 / lift / 1500 ft (for max 1300 cy)	<u> </u>	<u> </u>
<u> </u>	Verification Density Tests	1 / 10 req'd QC tests	<u> </u>	<u> </u>

Independent Assurance Tests --- Materials will furnish report(s)

Proctor Test	1 / project or systems approach	<u> </u>	<u> </u>
Moisture Test Witness	1 / project or systems approach	<u> </u>	<u> </u>
In-Place Density Test Witness	1 / project or systems approach	<u> </u>	<u> </u>

Comments: _____

**PROCTOR DENSITY
CALC WORKSHEETS**

Proctor Density Calculation

Pan Number		Point 1	Point 2	Point 3	Point 4	Point 5
Mass of wet soil + Pan, A, in grams	A					
Mass of dry soil + Pan, B, in grams	B					
Mass of Pan, C, in grams	C					
Mass of dry soil, D = B - C, in grams	D					
Mass of water, E = A - B, in grams	E					
Moist. Content , F = 100 x E / D , in %	F					
Proctor Mold mass, G, in grams	G					
Soil and Mold mass, H, in grams	H					
Soil mass, I = H - G, in grams	I					
Wet Den , J = I x 0.06614, in pcf	J					
Dry Den , L = J / [1 + (F / 100)], in pcf	L					

Proctor Density Calculation

		Point 1	Point 2	Point 3	Point 4	Point 5
Mass of wet soil + Pan, A, in grams	A					
Mass of dry soil + Pan, B, in grams	B					
Mass of Pan, C, in grams	C					
Mass of dry soil, D = B - C, in grams	D					
Mass of water, E = A - B, in grams	E					
Moist. Content , F = 100 x E / D , in %	F					
Proctor Mold mass, G, in grams	G					
Soil and Mold mass, H, in grams	H					
Soil mass, I = H - G, in grams	I					
Wet Den , J = I x 0.06614, in pcf	J					
Dry Den , L = J / [1 + (F / 100)], in pcf	L					

Proctor Density Calculation

Pan Number		Point 1	Point 2	Point 3	Point 4	Point 5
Mass of wet soil + Pan, A, in grams	A					
Mass of dry soil + Pan, B, in grams	B					
Mass of Pan, C, in grams	C					
Mass of dry soil, D = B - C, in grams	D					
Mass of water, E = A - B, in grams	E					
Moist. Content , F = 100 x E / D , in %	F					
Proctor Mold mass, G, in grams	G					
Soil and Mold mass, H, in grams	H					
Soil mass, I = H - G, in grams	I					
Wet Den , J = I x 0.06614, in pcf	J					
Dry Den , L = J / [1 + (F / 100)], in pcf	L					

Proctor Density Calculation

		Point 1	Point 2	Point 3	Point 4	Point 5
Mass of wet soil + Pan, A, in grams	A					
Mass of dry soil + Pan, B, in grams	B					
Mass of Pan, C, in grams	C					
Mass of dry soil, D = B - C, in grams	D					
Mass of water, E = A - B, in grams	E					
Moist. Content , F = 100 x E / D , in %	F					
Proctor Mold mass, G, in grams	G					
Soil and Mold mass, H, in grams	H					
Soil mass, I = H - G, in grams	I					
Wet Den , J = I x 0.06614, in pcf	J					
Dry Den , L = J / [1 + (F / 100)], in pcf	L					

Proctor Density Calculation

		Point 1	Point 2	Point 3	Point 4	Point 5
Mass of wet soil + Pan, A, in grams	A					
Mass of dry soil + Pan, B, in grams	B					
Mass of Pan, C, in grams	C					
Mass of dry soil, D = B - C, in grams	D					
Mass of water, E = A - B, in grams	E					
Moist. Content , F = 100 x E / D , in %	F					
Proctor Mold mass, G, in grams	G					
Soil and Mold mass, H, in grams	H					
Soil mass, I = H - G, in grams	I					
Wet Den , J = I x 0.06614, in pcf	J					
Dry Den , L = J / [1 + (F / 100)], in pcf	L					

Proctor Density Calculation

		Point 1	Point 2	Point 3	Point 4	Point 5
Mass of wet soil + Pan, A, in grams	A					
Mass of dry soil + Pan, B, in grams	B					
Mass of Pan, C, in grams	C					
Mass of dry soil, D = B - C, in grams	D					
Mass of water, E = A - B, in grams	E					
Moist. Content , F = 100 x E / D , in %	F					
Proctor Mold mass, G, in grams	G					
Soil and Mold mass, H, in grams	H					
Soil mass, I = H - G, in grams	I					
Wet Den , J = I x 0.06614, in pcf	J					
Dry Den , L = J / [1 + (F / 100)], in pcf	L					

Proctor Density Calculation

		Point 1	Point 2	Point 3	Point 4	Point 5
Mass of wet soil + Pan, A, in grams	A					
Mass of dry soil + Pan, B, in grams	B					
Mass of Pan, C, in grams	C					
Mass of dry soil, $D = B - C$, in grams	D					
Mass of water, $E = A - B$, in grams	E					
Moist. Content , $F = 100 \times E / D$, in %	F					
Proctor Mold mass, G, in grams	G					
Soil and Mold mass, H, in grams	H					
Soil mass, $I = H - G$, in grams	I					
Wet Den , $J = I \times 0.06614$, in pcf	J					
Dry Den , $L = J / [1 + (F / 100)]$, in pcf	L					

Proctor Density Calculation

		Point 1	Point 2	Point 3	Point 4	Point 5
Mass of wet soil + Pan, A, in grams	A					
Mass of dry soil + Pan, B, in grams	B					
Mass of Pan, C, in grams	C					
Mass of dry soil, $D = B - C$, in grams	D					
Mass of water, $E = A - B$, in grams	E					
Moist. Content , $F = 100 \times E / D$, in %	F					
Proctor Mold mass, G, in grams	G					
Soil and Mold mass, H, in grams	H					
Soil mass, $I = H - G$, in grams	I					
Wet Den , $J = I \times 0.06614$, in pcf	J					
Dry Den , $L = J / [1 + (F / 100)]$, in pcf	L					

GRAPHING PAPER

Sample 1

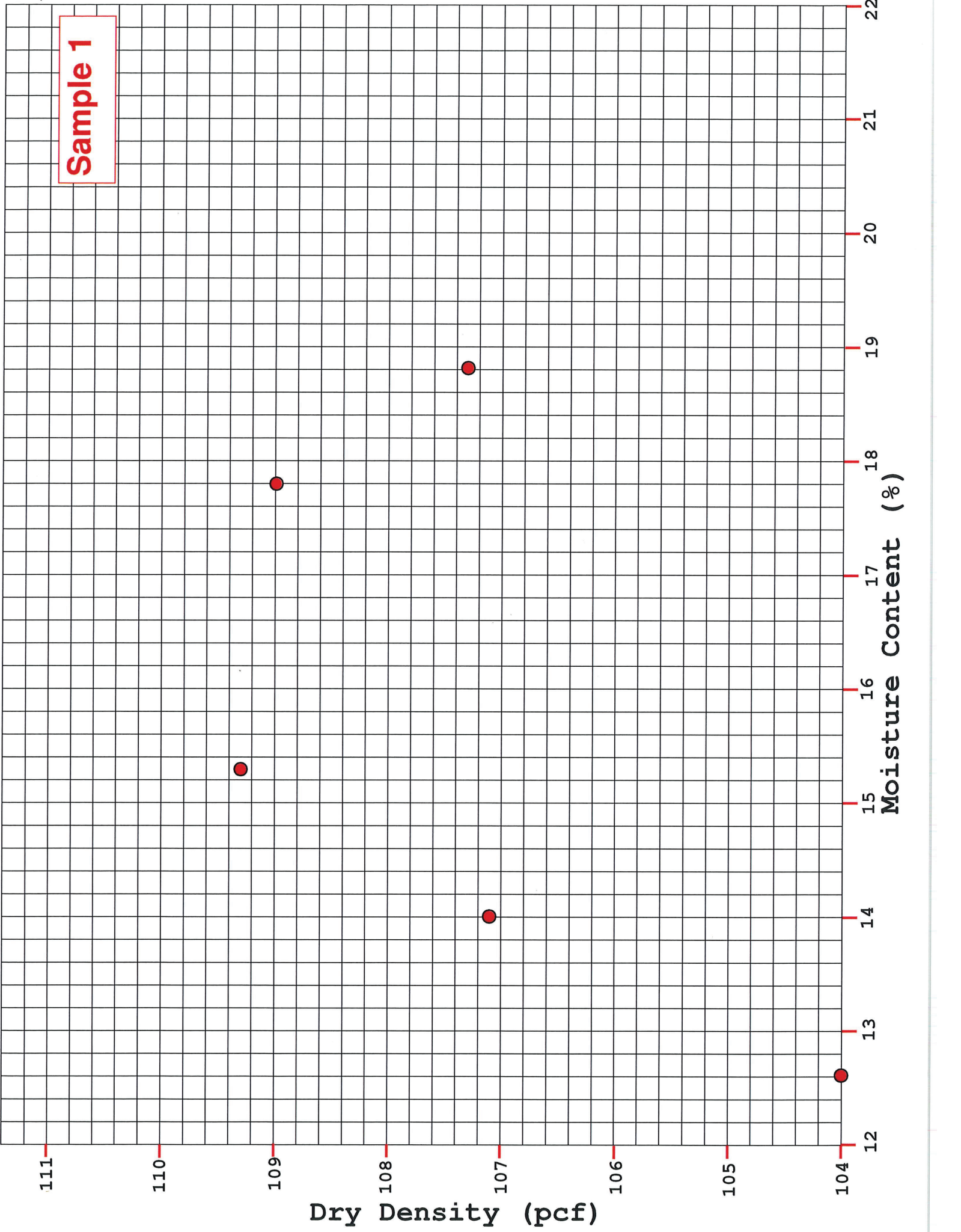

Sample 2

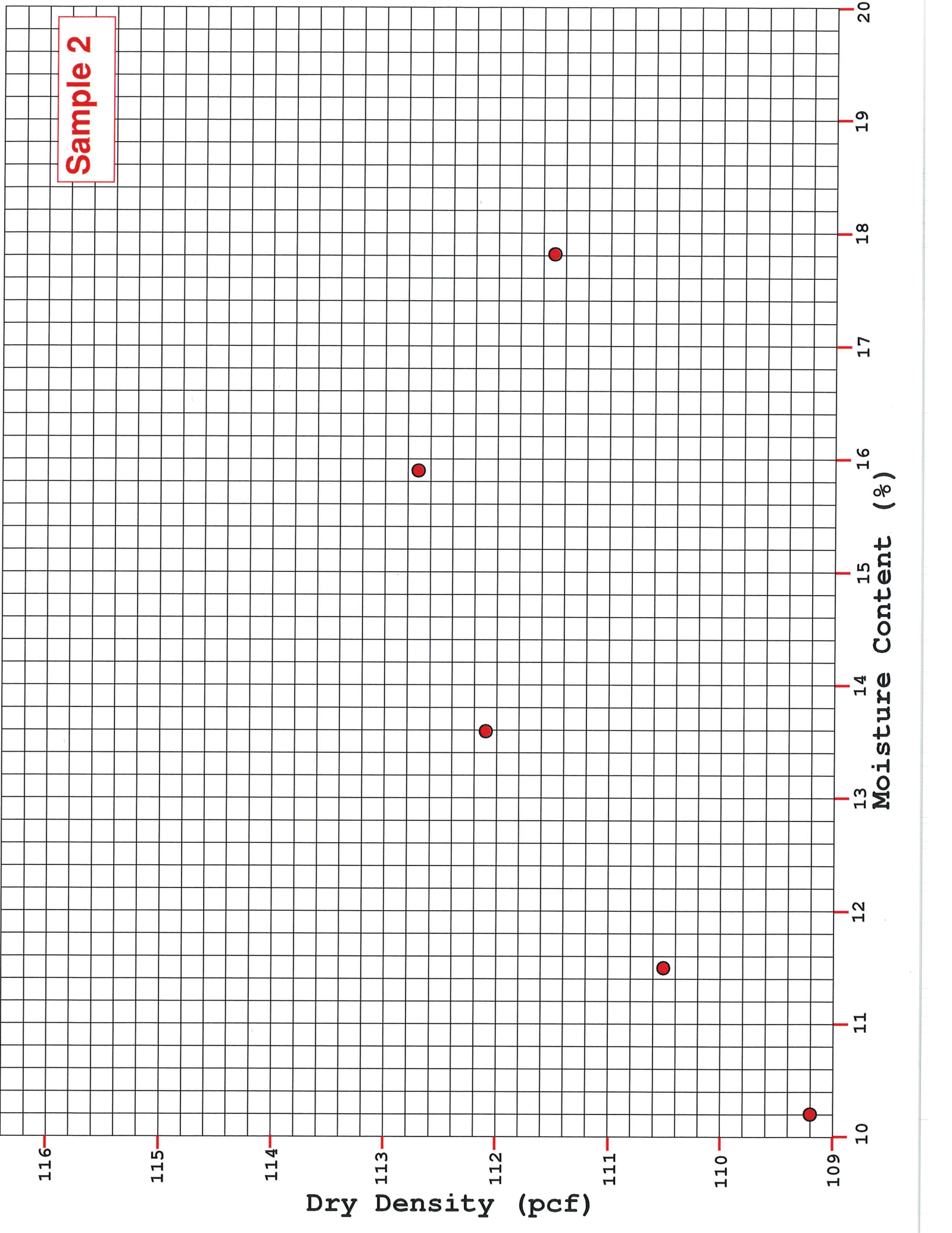

Lab - Day 2

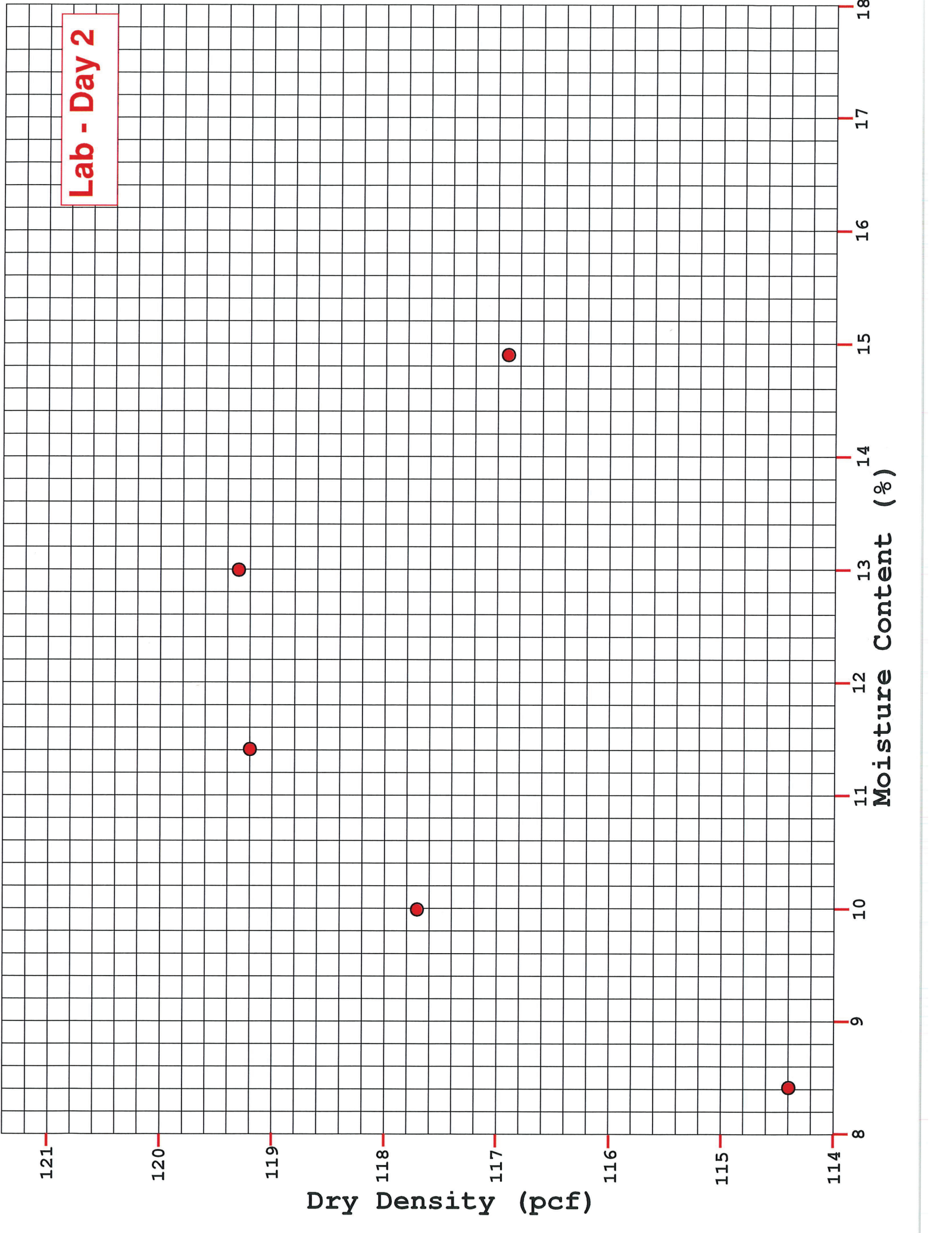

POWERPOINT



1

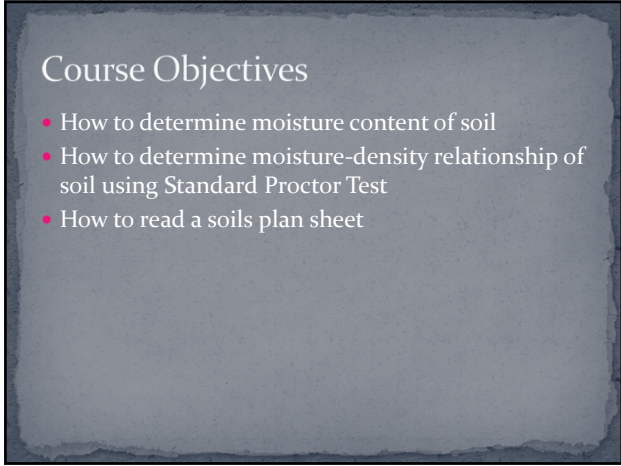

2

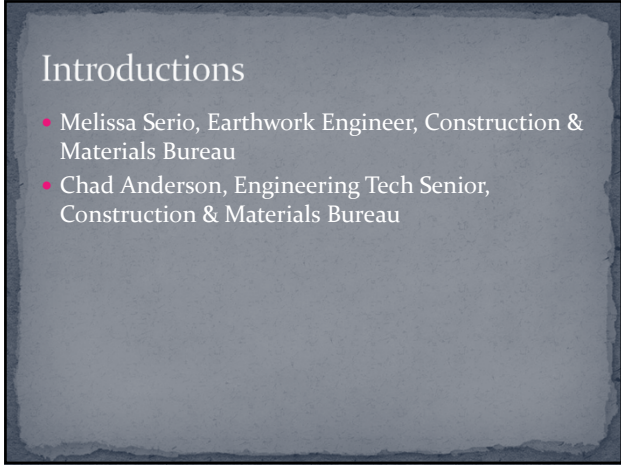

3

Now it's your turn

- Workplace
- Experience with soils

4

If you have a phone

Use below QR code



Or go to pollev.com/reneewhite885

Or send a text to 37607 with message reneewhite885

If it asks you to register, you can "Skip for now"

You can also "Skip" if it asks for your name.

5

Where do you work?

(A) Iowa DOT	0
(B) Consultant (non-geotech)	0
(C) Geotech consultant or testing company	0
(D) City or county	0
(E) Contractor	0
(F) Other	0

Start the presentation to see live content. For screen share software, share the entire screen. Get help at pollev.com/app

6

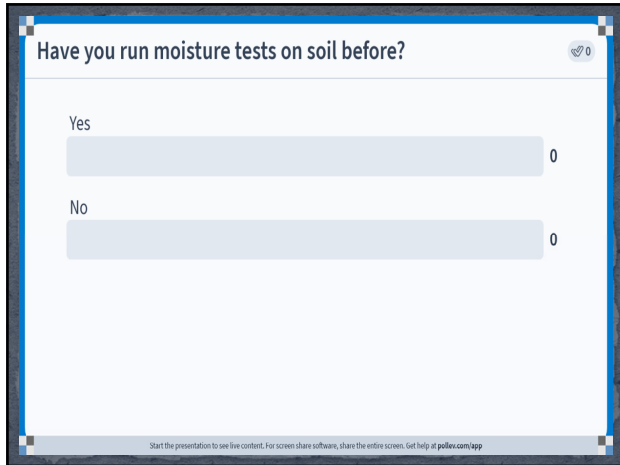

7

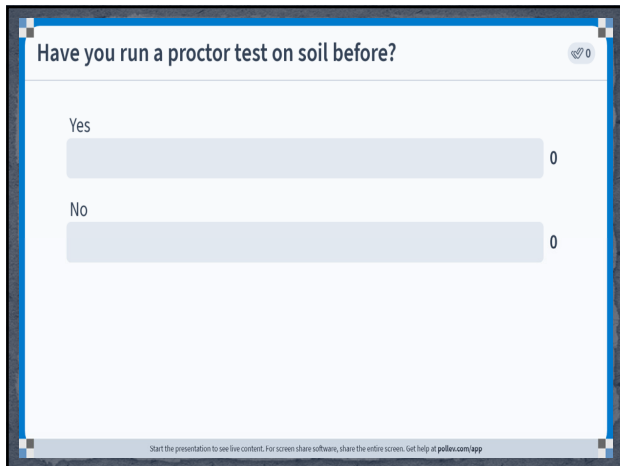

8

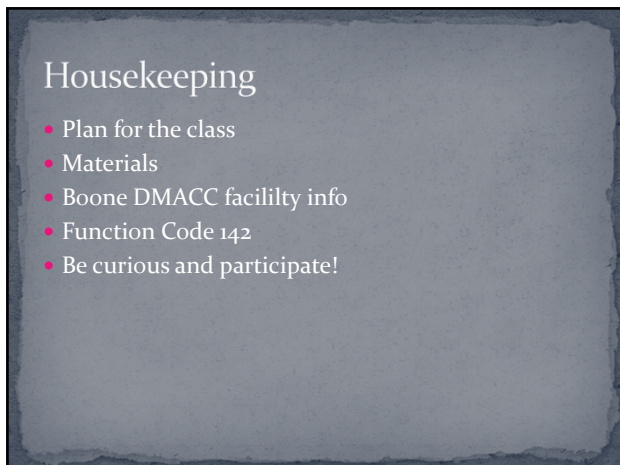

9

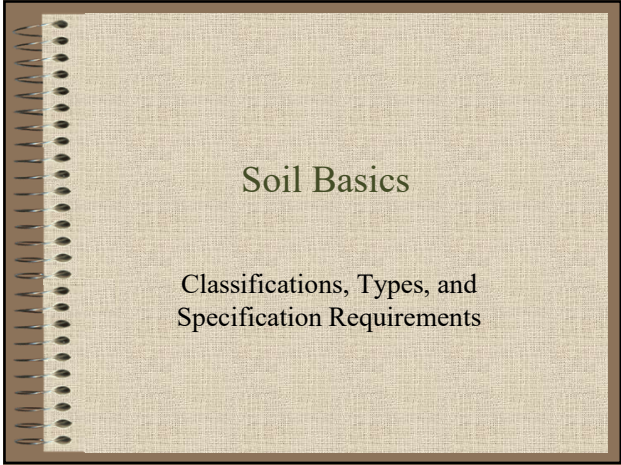

1

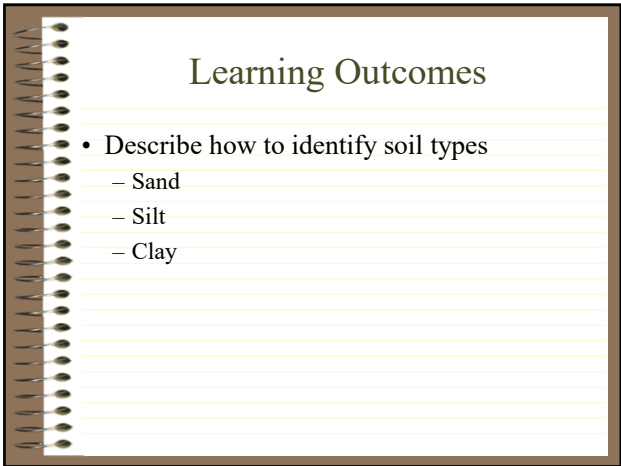

2

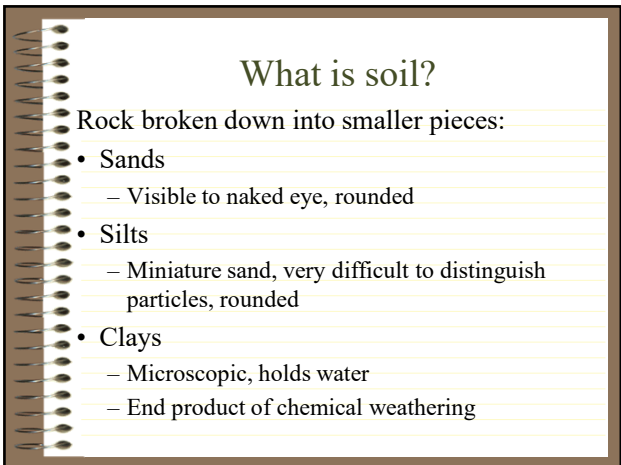

3

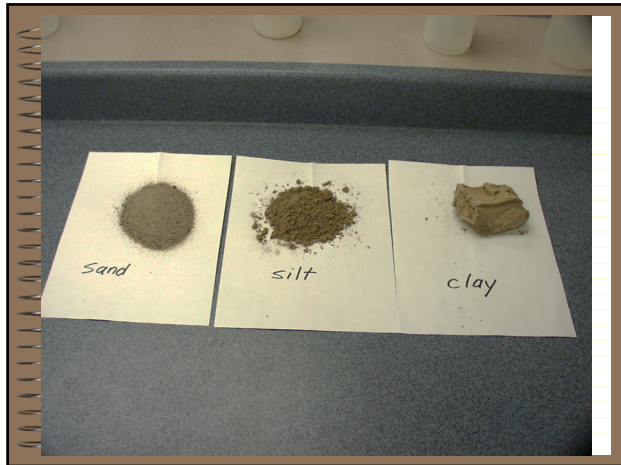

4

GRAVEL, SAND, SILT & CLAY

- Gravel > #10 sieve (2 mm)
or > #4 sieve (4.75 mm)
- Sand > #200 sieve (0.074 mm)
< -----Naked-eye limit at #200 sieve
- Silt > 0.002 mm
- Clay < 0.002 mm

 A diagram showing a vertical stack of sieves used for soil classification. From top to bottom, the sieves are labeled: 1/2" SIEVE, 3/8" SIEVE, #4 SIEVE, #10 SIEVE, #40 SIEVE, #200 SIEVE, and PAN. The diagram illustrates how particles of different sizes are retained at different stages of the sieve stack.

5



6

GRAVELS, SANDS
(granular or “cohesionless” soil)

- Identification - by eye
- Permeable to water, easily drained
 - Show video
- Settlement is small and happens right away
- Can act more like silts and clays if ‘dirty’

7

CLAYS

- Cohesive soils
- Identification
 - Plastic: can be molded when wet
 - Sticky and ‘buttery’ when wet
 - Dries hard in chunks
 - Shrinkage cracks after drying
- Strong when dry
- BUT loses much of its strength when wet

8



9

SILTS

- Is a transition between sand and clay
- Identification
 - Powdery like talc
 - Particles have a gritty texture.
- Windblown silt common in Iowa is loess



10

SILTS

- High capillary wicking potential, which makes it bad for frost action under roadbeds

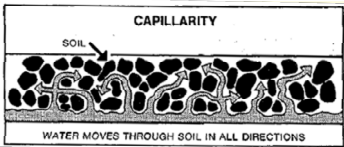

11

How can you tell the difference
between clay and silt?

Let's go to your binder!
Appendix Tab. Page 35

12

Learning Outcomes Check - in

- What type of soil is clay?
- What type of soil is sand?

13

Learning Outcomes

- Compare Soil Classification Systems
- List tests that are needed

14

SOIL CLASSIFICATION

- Needed because soils are a mix of materials and sizes
- Useful for practical purposes
- AASHTO
- USDA

15

AASHTO M 145

- “Classification of Soils and Soil-Aggregate Mixtures for Highway Construction Purposes”
- Gravels and Sands A-1, A-2, A-3
- Silts A-4, A-5
- Clays A-6, A-7
- Modifier - second number A-2-6
- Group Index A-7-6 (30)

16

AASHTO cont.

TESTS NEEDED:

- Gradation/sieve analysis:
 - Sieve gradation above #200 sieve
 - Passing #200 sieve = (silt + clay)
- Atterberg Limits/Plasticity:
 - Provides index properties of soil as moisture content increases
 - Plastic Limit - PL, Liquid Limit - LL

17

TABLE 1 Classification of Soils and Soil-Aggregate Mixtures (with Suggested Subgroups)

General Classification	Granular Materials (35% or less passing No. 200)								Silt-Clay Materials (More than 35% passing No. 200)			
	A-1		A-3	A-2				A-7				
Group Classification	A-1-a	A-1-b	A-3	A-2-4	A-2-5	A-2-6	A-2-7	A-4	A-5	A-6	A-7-5	A-7-6
Sieve analysis, percent passing:												
No. 10	50 max.											
No. 40	30 max.	50 max.	51 min.									
No. 200	15 max.	25 max.	10 max.	35 max.	35 max.	35 max.	35 max.	36 min.	36 min.	36 min.	36 min.	36 min.
Characteristics of fraction passing No. 40:												
Liquid limit				40 max.	41 min.	40 max.	41 min.	40 max.	41 min.	40 max.	41 min.	41 min.
Plasticity index	6 max.		NP	10 max.	10 max.	11 min.	11 min.	10 max.	10 max.	11 min.	11 min.	11 min.
Usual types of significant constituent materials	Stone fragments, gravel and sand		Fine sand	Silty or clayey gravel and sand				Silty soils		Clayey soils		
General rating as subgrade				Excellent to good				Fair to poor				

*Classification procedure: With required test data available, proceed from left to right on above chart and correct group will be found by the process of elimination. The first group from the left into which the test data will fit is the correct classification.
 *Plasticity index of A-7-5 subgroup is equal to or less than LL minus 30. Plasticity index of A-7-6 subgroup is greater than LL minus 30 (see Fig. 14.1).

18

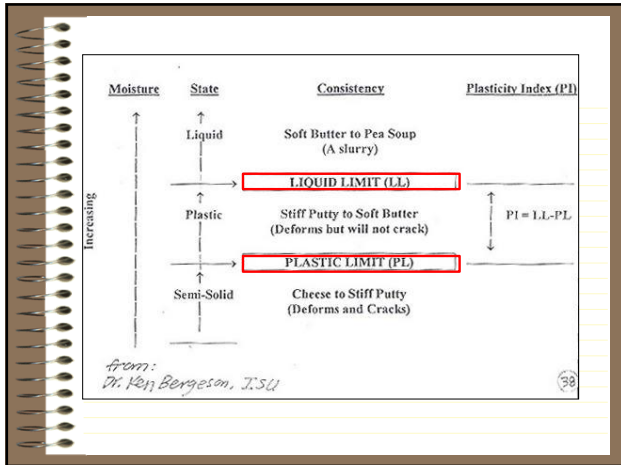

19

PLASTIC LIMIT (PL)

- Percent moisture at which soil becomes plastic like putty
- Defined as the lowest % moisture at which a 1/8" cylinder can be rolled

20



21

LIQUID LIMIT (LL)

- Percent moisture at which soil starts 'flowing'
- Uses an arbitrary but strict definition of 'liquid'
- Defined as the % moisture at which 25 drops of a calibrated cup will cause 1/2" closure of a separating groove made in a soil mass

22



23

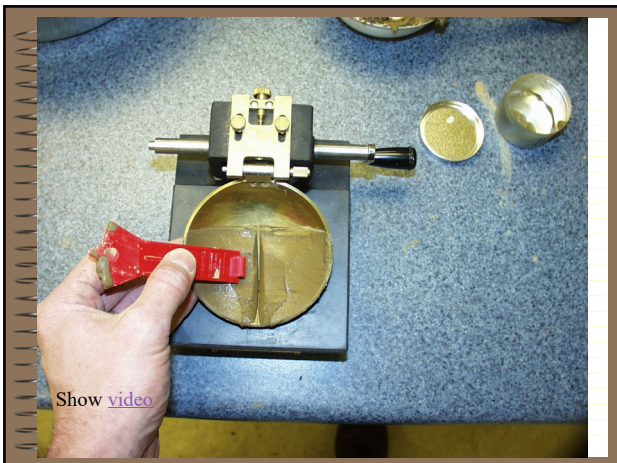

24

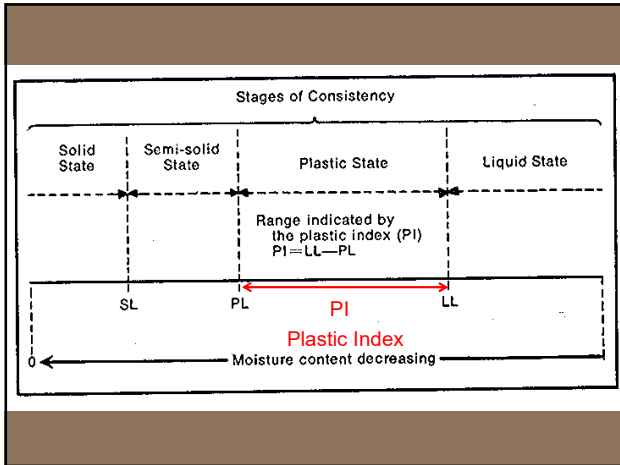

25

AASHTO M 145-91

- “Classification of Soils and Soil-Aggregate Mixtures for Highway Construction Purposes”
- Gravels and Sands A-1, A-2, A-3
- Silts A-4, A-5
- Clays A-6, A-7
- Modifier - second number A-2-6
- **Group Index** A-7-6 (**30**)

26

Group Index (GI)

- $GI = (F-35)[0.2 + 0.005(LL-40)] + 0.01(F-15)(PI-10)$
- Typically, if GI is 30 or greater, the soil is considered unsuitable and to have poor bearing characteristics
- F is the % passing #200 sieve

27

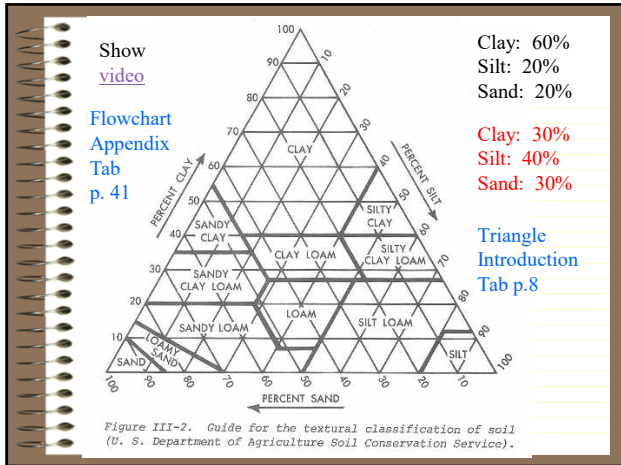

31

Now let's apply this to our jobs!

- Find where soils are classified on the Q-sheets

32

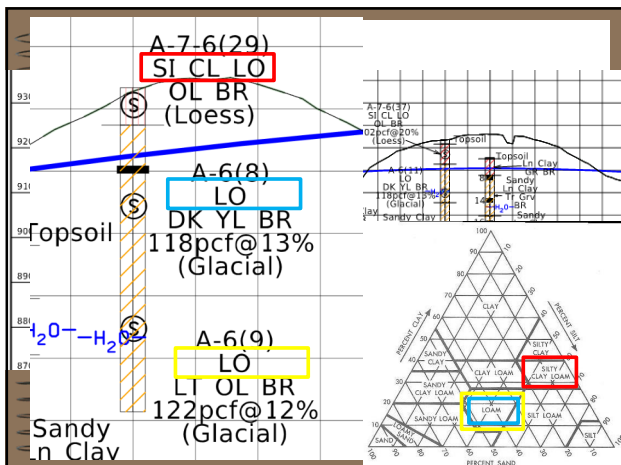

33

Learning Outcomes

- Describe the “types/groups” of Iowa DOT material
- Identify where unsuitable material can be placed

34

Iowa DOT Specification Requirements

- Reference: Section 2102 of the Standard Specifications



IOWA DOT
Electronic Reference Library
Standard Specifications for
Highway and Bridge Construction

35

Select Soils

- The “good stuff”
- Used for subgrade treatment
- The best quality granular or cohesive material for supporting pavements
- Can be granular or cohesive or special backfill material

36

Select Soils



1. **Select Treatment Material.**

a. **Cohesive Soils.**
 Meet all of the following requirements:
 1) 45% or less silt size fraction. Silt size particles are 0.074 to 0.002 mm.
 2) 110 pounds per cubic foot or greater density (AASHTO T 99 Proctor Density or Materials I.M. 309).
 3) Plasticity index greater than 10.
 4) A-6 or A-7-6 soils of glacial origin.

b. **Granular Soils.**
 Meet all of the following requirements:
 1) 15% or less silt and clay.
 2) 110 pounds per cubic foot or greater density (AASHTO T 99 Proctor Density or Materials I.M. 309).
 3) Plasticity index, 3 or less.
 4) A-1, A-2, or A-3 (0).

37

Suitable Soils



- The “okay stuff”
- Soils not meeting the specification requirements are considered unsuitable

2. **Suitable Soils.**

a. Ensure all soils provided for the construction of embankments meet the requirements below. They are suitable when moisture control or moisture and density control is designated.
 1) 95 pounds per cubic foot or greater density (AASHTO T 99 Proctor Density or Materials I.M. 309).
 2) AASHTO M 145 index of less than 30.
 3) Liquid Limit (LL) less than 50.

b. Soils not meeting these requirements are considered unsuitable soils, regardless of classification.

38

Unsuitable Soils



- The “bad stuff”
- Poor pavement support material
- To be typically buried deeper in the embankment
- See Standard Road Plan EW-102 on where material can be placed

39

What type of material is A-7-6(33)? 0

- Select 0
- Suitable 0
- Unsuitable, Type A 0
- Unsuitable, Type B 0
- Unsuitable, Type C 0

Start the presentation to see live content. For screen share software, share the entire screen. Get help at polllev.com/app

43

What type of material is A-7-6(28) with proctor density of 120 pcf & LL of 35? 0

- Select 0
- Suitable 0
- Unsuitable, Type A 0
- Unsuitable, Type B 0
- Unsuitable, Type C 0

Start the presentation to see live content. For screen share software, share the entire screen. Get help at polllev.com/app

44

What type of material is A-7-6(28) with a proctor density of 93 pcf? 0

- Select 0
- Suitable 0
- Unsuitable, Type A 0
- Unsuitable, Type B 0
- Unsuitable, Type C 0

Start the presentation to see live content. For screen share software, share the entire screen. Get help at polllev.com/app

45

What are three types of DOT material groups/types (Select all that apply)? 0

- Select 0
- Suitable 0
- Unsuitable 0
- Unstable 0

Start the presentation to see live content. For screen share software, share the entire screen. Get help at polllev.com/app

46

Where can I look to find where unsuitable material can be placed (Select all that apply)? 0

- Specification 2102 0
- Materials IM 309 0
- Standard Road Plan EW-102 0
- Design Detail 2602 0

Start the presentation to see live content. For screen share software, share the entire screen. Get help at polllev.com/app

47

DENSITY AND COMPACTION

Learning Outcomes:

- Explain density and moisture relationship
- Describe Standard Proctor Test
- Find optimum moisture and maximum density

1

DENSITY AND COMPACTION

- Goal with compaction is to increase density
- Density = Mass / Volume
- Density units
 - Typically use pcf (pounds per cubic foot)
- Will be calculating dry density which is the dry soil per unit volume
- Also, will be calculating wet density

2

DENSITY AND COMPACTION

- Primary purpose is to drive AIR out of the soil/water/air mix

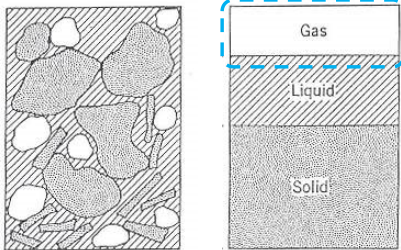

3

FACTORS AFFECTING COMPACTION

- Moisture content at time of compaction
- Soil type - material and gradation
- Compactive effort - equipment and passes
- Lift thickness - limits compaction depth

4

Effect of Moisture on Soil

- Friction between particles is high for soil in a dry condition.
- As moisture increases, the water acts as a lubricant and the friction is reduced.

5

So what does this mean???

- Too dry....
- Too wet....
- Just right.



6

STANDARD PROCTOR TEST

- Finds the best moisture for compaction – the “just right” area

You can find Moisture Control Limits in Spec. 2107, which are -2.0% to +2.0%

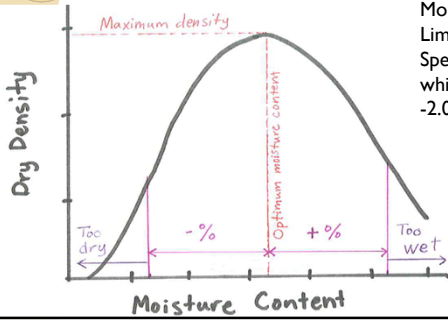

7

Equipment:

- Mold volume of 1/30 cubic foot (4 inches in diameter)
- Standard Proctor uses 5.5 lb. hammer, 12" drop, 25 blows per each of 3 lifts

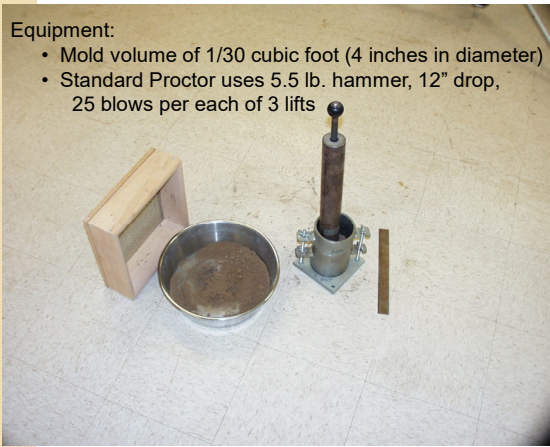

8

So, how do you get here?

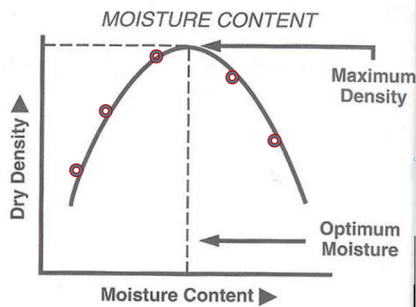

9

Let's go over the data that is collected and the calculations performed

10

How to calculate moisture content

- Weigh wet sample
- After sample is dried to a constant mass, weigh dry sample,
- Calculate mass of water in sample
- Moisture content in % =

$$100 \times \frac{\text{mass of water in the sample}}{\text{mass of dry soil}}$$

Note: Moisture content is calculated when checking moisture content of a lift in the field and for Standard Proctor Test.

11

Let's try a sample calculation!

Moisture Content



Go to page 23
Introduction Tab,
Sample 1, Point 1

12

Proctor Density Calculation Sample 3

	Point 1
Mass of wet soil + Pan, A, in grams	A 397.7
Mass of dry soil + Pan, B, in grams	B 364.4
Mass of Pan, C, in grams	C 100.1
Mass of dry soil, D = B - C, in grams	D 264.3
Mass of water, E = A - B, in grams	E 33.3
Moist. Content, F = 100 x E / D, in %	F 12.6

13

How to calculate wet density

- Calculate soil mass in mold
- We know the volume of the mold, so we can now calculate wet density
- Remember: Density = Mass/Volume

14

Proctor Mold mass, G, in grams	G 1804.4
Soil and Mold mass, H, in grams	H 3574.8
Soil mass, I = H - G, in grams	I 1770.4
Wet Den, J = I x 0.06614 in pcf	J 117.1

Where does 0.06614 come from?

$$\text{Wet density (in lbs./ft.}^3\text{)} = I \times 0.06614$$

$$= \text{soil mass (in grams)} \times 0.06614$$

$$0.06614 = 1 / (\text{volume of mold} \times \text{grams to lbs conversion factor})$$

$$= 1 / (1/30 \text{ ft.}^3 \times 453.6 \text{ g/lb}) = 1/15.12$$

15

How to calculate dry density

- Use moisture content previously calculated
- Use wet density previously calculated
- Dry density =

$$\frac{\text{wet density}}{[1 + (\frac{\text{moisture content}}{100})]}$$

16

Dry density = $\frac{\text{wet density}}{[1 + (\frac{\text{moisture content}}{100})]}$

There are various ways to do this calculation:

1. Enter everything into your calculator step-by- step. But remember order of operations!
2. Enter everything into calculator, incl. parentheses (if your calculator is capable of this).
3. Do the **bottom part** of the calculation without a calculator. **Then** enter wet density divided by bottom part into your calculator. Examples for bottom part:
 - Moisture content 10.4%. Divide by 100, which moves decimal over two spots (0.104). Then add 1. So bottom part becomes 1.104.
 - Moisture content 9.8%. Divide by 100, which moves decimal over two spots (0.098). Then add 1. So bottom part becomes 1.098.

17

	Point 1	Page 23
Mass of wet soil + Pan, A, in grams	A 397.7	
Mass of dry soil + Pan, B, in grams	B 364.4	
Mass of Pan, C, in grams	C 100.1	
Mass of dry soil, D = B - C, in grams	D 264.3	
Mass of water, E = A - B, in grams	E 33.3	
Moist. Content, F = 100 x E / D, in %	F 12.6	
Proctor Mold mass, G, in grams	G 1804.4	
Soil and Mold mass, H, in grams	H 3574.8	
Soil mass, I = H - G, in grams	I 1770.4	
Wet Den, J = I x 0.06614, in pcf	J 117.1	117.1
Dry Den, L = J / [1 + (F / 100)], in pcf	L 104.0	1.126

18

Let's complete the calculations for Sample #1!

Page 23



19

	Point 1	Point 2	Point 3	Point 4	Point 5
Mass of wet soil + Pan, A, in grams	A 397.7	392.3	415.8	388.7	385.7
Mass of dry soil + Pan, B, in grams	B 364.4	356.5	373.9	345.1	340.5
Mass of Pan, C, in grams	C 100.1	100.1	100.1	100.1	100.1
Mass of dry soil, D = B - C, in grams	D 264.3	256.4	273.8	245	240.4
Mass of water, E = A - B, in grams	E 33.3	35.8	41.9	43.6	45.2
Moist. Content, F = 100 x E / D, in %	F 12.6	14.0	15.3	17.8	18.8
Proctor Mold mass, G, in grams	G 1804.4	1804.4	1804.4	1804.4	1804.4
Soil and Mold mass, H, in grams	H 3574.8	3650.5	3709.4	3745.7	3732.1
Soil mass, I = H - G, in grams	I 1770.4	1846.1	1905	1941.3	1927.7
Wet Den, J = I x 0.06614, in pcf	J 117.1	122.1	126	128.4	127.5
Dry Den, L = J / [1 + (F / 100)], in pcf	L 104.0	107.1	109.3	109.0	107.3
	1.126	1.140	1.153	1.178	1.188

20

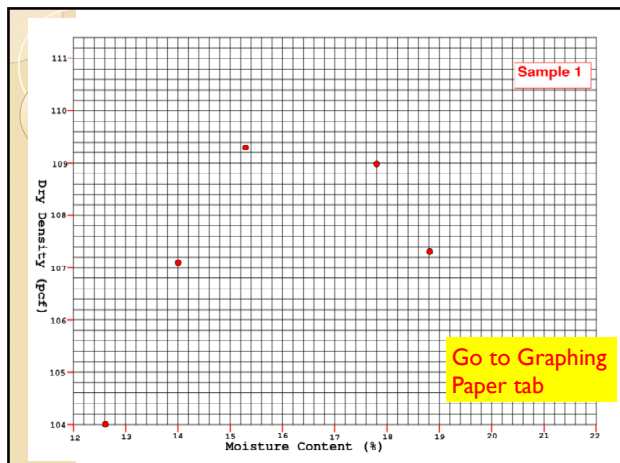

21

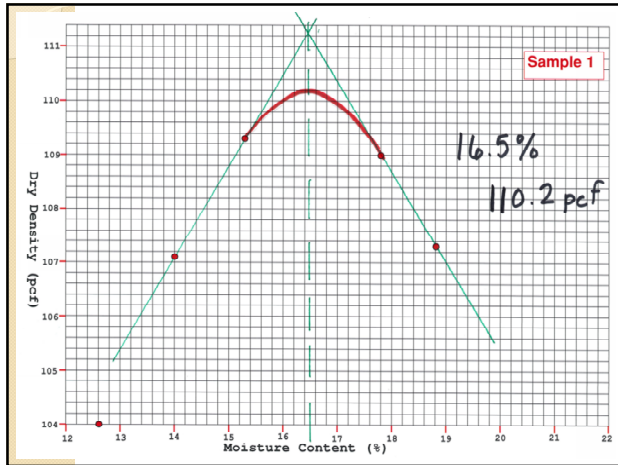

22

One-Point Proctors – Another option

- Learning outcomes:
 - Determine optimum moisture content and maximum dry density using One-Point Proctor curve

23

Reference
IM 309
Page 5

Example:
Moisture 12%
Wet density 124 pcf

Curve No.	Dry Weight	Moisture
1	128	8.0
2	128	10.1
3	127	12.4
4	128	13.7
5	125	14.6
6	124	15.2
7	123	15.8
8	122	15.7
9	121	15.8
10	120	15.3
11	119	15.8
12	118	15.9
13	117	15.8
14	116	15.6
15	115	15.4
16	114	14.8
17	113	14.1
18	112	13.6
19	111	12.9
20	110	12.3
21	109	11.7
22	108	11.1
23	107	10.5
24	106	9.9
25	105	9.3
26	104	8.7
27	103	8.1
28	102	7.5
29	101	6.9
30	100	6.3
31	99	5.7
32	98	5.1
33	97	4.5
34	96	3.9
35	95	3.3
36	94	2.7
37	93	2.1
38	92	1.5
39	91	0.9
40	90	0.3
41	89	-0.3
42	88	-0.9
43	87	-1.5
44	86	-2.1
45	85	-2.7

Example calculation:
Wet Density (lb/cu. ft) = 124 pcf
Moisture = 12%
Dry Density = 124 / (1 + 0.12) = 110.7 pcf

24

One-Point Test Procedure

- Prepare sample with an estimated moisture content of zero to 3% below optimum moisture
- If point falls outside of the “Range of Confidence”, recompact another specimen at an adjusted moisture content that will place the point within the range
- Not accurate for certain granular materials, black soils or soils with considerable amount of aggregate

HOW DO WE APPLY COMPACTION REQUIREMENTS TO OUR PROJECTS?

- Learning Outcomes:
 - Review Standard Specifications 2107
 - Show and Explain Different Types of Testing Methods – Moisture Content & Density

1



Standard Specifications for
Highway and Bridge Construction

<https://iowadot.gov/erl>

2

Be sure you use the correct specifications!

Check the letting date and use the correct GS version.

<https://iowadot.gov/erl>

3

Section 2107: Embankments

Provides requirements for building (i.e. compacting) embankments, such as:

- Type of equipment,
- Number of passes,
- Roller walk-out, and
- Moisture Control or Moisture & Density Control



Let's go to your binders –
Specifications Section 2107

4

A. General. First page of Section 2107

1. Prepare the site, and place and compact excavated materials to the required elevation and cross section shown in the contract documents.
2. If the type of compaction is not specified, **Type A compaction** will be required.

B. Equipment.

Use equipment that meets the requirements of Section 2001 and the following:

This will be defined on next page.

1. Compaction Equipment.

- a. When compaction with moisture and density control is not specified, **use equipment that meets the requirements of Article 2001.05.A.** Other types of compacting equipment may be used as provided in Article 2107.03, G.
- b. For compaction of sand or other granular material, use either a: **This is sheepfoot roller.**
 - Self propelled pneumatic roller meeting the requirements of Article 2001.05, C, or
 - Self propelled vibratory roller meeting the requirements of Article 2001.05, F.



5

D. Depositing Embankment Material.

1. Comply with the following:
 - a. Except for rock fills and granular blankets, **deposit embankments in horizontal layers not over 8 inches in loose thickness.**

E. Type A Compaction: Flip to next page

1. Type A compaction refers to compaction requiring a **minimum of one rolling per inch depth of each lift.** A further requirement is that the roller continues operation until it is supported on its feet, or the equivalent.
2. After smoothing the surface of the layer and before depositing material for the next layer, compact the layer with at least one pass of the sheepfoot type roller for each inch of loose thickness of the layer. **Compact until the roller is supported entirely on its feet. This occurs when the tamping feet penetrate no more than 3 inches into an 8 inch lift or 33% of the depth of the layer being placed.**

Roller walk-out

Roller Feet Embedded to Within 2 Inches of the Drum

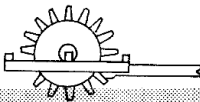

Roller After it has "Walked Out"

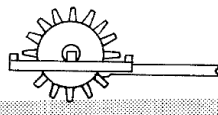

6. **The Contractor may request approval of other methods and equipment according to Article 2107.03, G.** **See next page**

6

What happens if lift thickness is too large?



10

Settlement



11

Soft Spots



12

HOW DO WE TEST MOISTURE???

13

IM 335 – Determining Moisture Content of Soils

Provides for 3 test methods of drying:

- Drying oven
- Microwave
- Direct heat

14

TIPS FOR DRYING

1. Dry specimen to a constant weight (i.e. dry until change in mass would have an insignificant effect on calculated moisture content). In most specimens, a change of 0.1% or less of wet soil mass in last two checks would be acceptable.

2. Make sure none of specimen is lost when stirring.

15

TIPS FOR DRYING

- 3. Do not overheat specimen. This can cause a higher than actual moisture content to be determined. Use incremental drying!
- 4. Make sure the same pan is used for each weighing.
- 5. Specimens used in this test should not be used for any other tests after drying.

16

HOW DO WE TEST COMPACTION?

17

Density Tests

- Nuclear gauge
- Sand cone density test
- Balloon density test
- Soil core (drive cylinder)



[Play video](#) showing summary of first three tests

18

**TEST FOR DENSITY BY SOILS CORES BY
DISPLACEMENT (DRIVE CYLINDER)**

ASTM D2937

**In-place
Wet Density = $\frac{(\text{mass of cylinder} + \text{wet soil}) - (\text{mass of cylinder})}{\text{Volume of cylinder}}$**



19

Drive Cylinder Example

Mass of cylinder + wet soil: Say 2.5 lb.

Mass of cylinder: Say 1.3 lb.

Volume of cylinder: Say 0.01 ft.³

Note: For simplicity in this example, we are providing mass in pounds.

What is in-place wet density?

20

Drive Cylinder Example

Let's say you took a moisture content sample and determined moisture content to be 14%.

What is in-place dry density?

21

% Density Requirements

- Learning Outcomes:

Calculate required in-place density/field dry density when a % compaction requirement is given

22

Example of % density requirement

- Say maximum dry density is 115.0 pcf and specifications require in-place density to be 95% of maximum dry density
- What is the dry density that contractor must obtain in the field?

[See next slide for calculation.](#)

23

Here's how it's done!

Known:

- Maximum dry density is 115.0 pcf
- Density is required to be 95% of maximum dry density

Required in-place dry density =

Req'd % compaction/100 x max dry density =
 $95/100 \times 115 \text{ pcf} = 0.95 \times 115.0 \text{ pcf} = \underline{109.3 \text{ pcf}}$

24

Higher than Maximum Density

- It is possible to achieve a higher density in the field than what was calculated in the lab, if the unit weight exerted in the field is higher than that exerted in the lab.
- So, if you get a compaction of over 100%, this may be why.

25

Learning Outcomes Check-in

Let's say contract requires 90% of maximum dry density

You run proctor test and come up with the following:

- Maximum dry density is 112.0 pcf
- Optimum moisture content is 14.5%

What dry density do you need in the field?

26

Learning Outcomes Check-in

Another example -

You run proctor test and come up with the following:

- Maximum dry density is 120.0 pcf
- In-place dry density is 113.0 pcf

What is **percent compaction**?

27

HOW OFTEN DO WE TEST?

28

Material IM 204, Appendix A

Sampling & Testing Guide-Minimum Frequency
 April 19, 2022
 Supersedes October 15, 2019

ROADWAY & BORROW EXCAVATION & EMBANKMENT
 Sections 2102, 2107, 2109 & 2432

MATERIAL OR CONSTRUCTION ITEM	TESTS	METHOD OF ACCEPTANCE & RELATED IMs	QUALITY CONTROL					INDEPENDENT ASSURANCE & VERIFICATION SAT				
			SAMPLE BY	FREQ.	SAMPLE SIZE	TEST BY	REPORT	SAT TYPE	SAMPLE BY	FREQ.	SAMPLE SIZE	
Moisture Control (QC by Contractor Note 1)	Proctor	329	CONTR	1/ soil class	25 lb	CONTR	Field Book & Test Report	V (7) IA (4)	CONTR/RCE/CONTR/DME	1/ 10 req'd QC tests (min. 1)(5)	25 lb.	
	Moisture	335, 331	CONTR	1/ 10/1500 ft. (for max. of 1300 cy) (6)	3 lb	CONTR	Field Book & Test Report	V (7) IA (4)	RCE (2) DME	1/ 10 req'd QC tests (min. 1)(5) Witness 10psi	3 lb.	
Moisture & Density Control, including Special Compaction of Subgrade (2.02.03C) (QC by Contractor Note 1)	Proctor	329	CONTR	1/ soil class	25 lb	CONTR	Field Book & Test Report	V (7) IA (4)	CONTR/RCE/CONTR/DME	1/ 10 req'd QC tests (min. 1)(5) Witness 10psi	25 lb.	
	Moisture	335, 331	CONTR	1/ 10/1500 ft. (for max. of 1300 cy) (6)	3 lb	CONTR	Field Book & Test Report	V (7) IA (4)	RCE (2) DME	1/ 10 req'd QC tests (min. 1)(5) Witness 10psi	3 lb.	
In-place Density	328 & 331, ASTM D2957, D2957, D1555, D6978(8), AASHTO T191 & T229	CONTR	1/ 10/1500 ft. (for max. of 1300 cy) (6)	As req'd by test	CONTR	Field Book & Test Report	V (7) IA (4)	RCE/DME/DME	1/ 10 req'd QC tests (min. 1)(5) Witness 10psi	As req'd		

29

If you have a phone

Use below QR code



Or go to pollev.com/renewwhite885

Or send a text to 37607 with message renewwhite885

If it asks you to register, you can "Skip for now"

You can also "Skip" if it asks for your name.

30

Which of the following is an acceptable way to measure in-place soil density (Select all that apply)?

- Soil core (drive cylinder)
- Balloon density
- Standard proctor test
- Nuclear gauge
- Sand cone density

Start the presentation to see live content. For screen share software, share the entire screen. Get help at pdxex.com/app

31

Using drive cylinder, you measure the following: Mass of cyl. + wet soil = 6.5 lb., Mass of cyl. = 3.0 lb., Vol. cyl. = 0.03 cu. ft. What is in-place wet density?

- 100 pcf
- 116.7 pcf
- 121.4 pcf
- 131.7 pcf

Start the presentation to see live content. For screen share software, share the entire screen. Get help at pdxex.com/app

32

What is % compaction if max. dry density is 116.4 pcf, in-place wet density is 132.1 pcf, and in-place dry density is 111.9 pcf?

- (A) 84.7
- (B) 88.1
- (C) 92.5
- (D) 96.1
- (E) 113.5

Start the presentation to see live content. For screen share software, share the entire screen. Get help at pdxex.com/app

33

Soils Review

1

If you have a phone

Use below QR code



Or go to pollev.com/reneewhite885

Or send a text to 37607 with message reneewhite885

If it asks you to register, you can "Skip for now"

You can also "Skip" if it asks for your name.

2

Where do I find minimum soils testing frequencies?

Specification 2102	0
Materials IM 204, Appendix A	0
Materials IM 213	0
Materials IM 216	0

Start the presentation to see live content. For screen share software, share the entire screen. Get help at pollev.com/app

3

Where do I find tolerances used to validate QC tests?

- Materials IM 204, Appendix A
- Materials IM 335
- Materials IM 309
- Tab 103-6
- Materials IM 216

Start the presentation to see live content. For screen share software, share the entire screen. Get help at pollex.com/app

4

Where do I find specified moisture range (-% and +% of optimum moisture content) for soil to be compacted with moisture control?

- Materials IM 204, Appendix A
- Materials IM 335
- Materials IM 309
- Materials IM 216
- Specifications Section 2107

Start the presentation to see live content. For screen share software, share the entire screen. Get help at pollex.com/app

5

Sampling for moisture should be

- Random
- Representative

Start the presentation to see live content. For screen share software, share the entire screen. Get help at pollex.com/app

Materials IM 312

6

What are the tolerances when validating proctor test results? ♥ 0

Proctor Opt. Moisture Content: +/- 1.5% and Proctor Max. Dry Density: +/- 2.0 pcf 0%

Proctor Opt. Moisture Content: +/- 1.5% and Proctor Max. Dry Density: +/- 5.0 pcf 0%

Proctor Opt. Moisture Content: +/- 2.0% and Proctor Max. Dry Density: +/- 2.0 pcf 0%

Proctor Opt. Moisture Content: +/- 2.0% and Proctor Max. Dry Density: +/- 5.0 pcf 0%

None of the above 0%

Start the presentation to see live content. For screen share software, share the entire screen. Get help at pollen.com/app

Materials IM 216

7

What equipment is needed for a standard proctor test (Select all that apply)? ♥ 0

Scale/Balance 0

Drying equipment 0

4-inch diameter proctor mold 0

10 lb. proctor hammer 0

Start the presentation to see live content. For screen share software, share the entire screen. Get help at pollen.com/app

8

How many blows per lift for the Iowa DOT standard proctor test?

5 0

20 0

25 0

50 0

Start the presentation to see live content. For screen share software, share the entire screen. Get help at pollen.com/app

Materials IM 309 and Worksheet

9

What sieves are used for the Iowa DOT standard proctor test (Select all that apply)?

No. 200

No. 4

3/4 inch

2 inch

Start the presentation to see live content. For screen share software, share the entire screen. Get help at pollux.com/app

Materials IM 309 and Worksheet

10

True/False: If I'm cooking soil using direct heat method, once the mirror stops fogging up, I can immediately stop heating the soil and take my final measurement.

True

False

Start the presentation to see live content. For screen share software, share the entire screen. Get help at pollux.com/app

11

True/False: Dry density always increases as moisture content increases.

True

False

Start the presentation to see live content. For screen share software, share the entire screen. Get help at pollux.com/app

12

When plotting a multiple point proctor curve, you will plot (Select all that apply)...

Wet density

Dry density

Moisture content

Dry weight of soil

Start the presentation to see live content. For screen share software, share the entire screen. Get help at pollux.com/app

13

When using the 1 point proctor curve, you use (Select all that apply)....

Dry density

Wet density

Moisture content

Dry weight of soil

Start the presentation to see live content. For screen share software, share the entire screen. Get help at pollux.com/app

14

Using 1 pt. proctor chart, if wet density is 111 pcf and M/C is 24%, what is the proctor density & opt. M/C?

91 pcf and 26.2%

90 pcf and 26.9%

89 pcf and 27.5%

Outside the range of confidence

Start the presentation to see live content. For screen share software, share the entire screen. Get help at pollux.com/app

15

Other info?

- Or helpful info:
- Formulas at a Glance page – right before **Introduction** tab
- Proctor Density Calculation Worksheets
