



# HMA Paving Field Inspection 2025



**Technical Training & Certification Program**



**HIGHWAY – SYSTEMS OPERATIONS DIVISION  
CONSTRUCTION & MATERIALS BUREAU**

# Table of Contents

<b>Chapter I</b>	<b>Introduction</b> .....	1-1
<b>Chapter II</b>	<b>Mix Properties</b>	
	Stability .....	2-1
	Density .....	2-1
	Workability .....	2-2
	Flexibility .....	2-2
	Durability .....	2-3
	Impermeability .....	2-3
	Fatigue Resistance .....	2-4
	Skid Resistance .....	2-4
	Smoothness .....	2-4
	Asphalt Binder Content .....	2-5
	Air Voids .....	2-6
<b>Chapter III</b>	<b>Equipment</b>	
	Brooms .....	3-1
	Tack Distributor .....	3-1
	Trucks .....	3-2
	Paver .....	3-3
	Rollers .....	3-5
	Windrow Pickup Elevator .....	3-6
	Material Transfer Vehicle (MTV) .....	3-7
	Mat Smoothness Machine .....	3-8
<b>Chapter IV</b>	<b>Role of the Inspector</b>	
	Description .....	4-1
	Important Documents .....	4-2
	Duties Typically Performed .....	4-6
<b>Chapter V</b>	<b>Traffic Control</b>	
	Flagger .....	5-1
	Standards .....	5-3
	Plan Notes & Detail Plan Sheets .....	5-5
	Traffic Control Devices .....	5-5
	Monitoring and Documentation .....	5-7
	Noncompliance .....	5-9

Accidents .....	5-10
-----------------	------

## **Chapter VI Preparation of Grade and Base**

Cleaning & Preparation of Base .....	6-1
Base Repair .....	6-1
Base Widening .....	6-2
Application of Tack Coat .....	6-3
Treatment of Fixtures .....	6-4
Fabric Reinforcement .....	6-5
Scarification .....	6-6
Heater Scarification .....	6-6
Cold In-place Recycling .....	6-8
Slab Fracturing Processes .....	6-11
Special Backfill .....	6-15
Modified Subbase .....	6-15
Unstable Subgrades and Subbases .....	6-16

## **Chapter VII Mix Delivery, Placement, and Compaction**

Truck Unloading .....	7-1
Dimensions .....	7-3
String Line .....	7-4
Edge Alignment .....	7-5
Wedge, Leveling and Strengthening Courses .....	7-5
Paver Speeds and Plant Production .....	7-7
Paver Operations .....	7-8
Runouts .....	7-9
Transverse Joints & Runouts .....	7-10
Longitudinal Joints .....	7-12
Hand Spreading .....	7-14
Compaction .....	7-14
Roller Operations .....	7-18
Classes of Compaction .....	7-19
Test Strips .....	7-21
Checking Roller Coverage .....	7-22

## **Chapter VIII Limitations and Miscellaneous Operations**

Warm Mix Asphalt .....	8-1
Recycled Asphalt Shingles .....	8-2
Safety Edge .....	8-3
Milled Shoulder Rumble Strips .....	8-4

Milled Centerline Rumble Strips .....	8-6
Granular Shoulders .....	8-7
Public Convenience and Safety .....	8-9
Haul Roads .....	8-10
Mat Surface Conditions .....	8-11
Surface Temperature .....	8-12
Mat Cooling .....	8-12
Mix Temperature .....	8-13
Calendar Dates .....	8-15
Cold Weather Paving .....	8-15
Winter Shutdown .....	8-16
Tickets, Quantities, and Yield .....	8-18
Contractor Sampling .....	8-20
Coring .....	8-21
Smoothness Testing .....	8-23

## **Chapter IX      Problems and Solutions**

Segregation .....	9-1
Tack Coat Application .....	9-5
Flushing or Bleeding .....	9-7
Tender Mixes .....	9-7
Mix Pickup .....	9-9
Roller Marks .....	9-10
Wavy Surface .....	9-10
Reflective Bumps .....	9-11
Cracking .....	9-12
Rutting .....	9-14
Crushing Aggregate .....	9-15
Longitudinal (Centerline) Joints .....	9-16
Screed Marks / Mat Texture .....	9-19
Mat Problem Trouble-Shooting .....	9-20

## **Chapter X      Appendix**

Superpave (Gyratory Mix Design) Discussion .....	10-1
HMA Paving in Iowa - A Brief History .....	10-3
Factors Influencing Compaction .....	10-9
Mat Problem Trouble-Shooting Guide .....	10-10
Asphalt Terminology (Glossary) .....	10-11
HMA Paving Field Inspection Checklist.....	10-29
Developmental Spec. for Electronic Ticketing .....	10-36

# **INTRODUCTION**

# I. Introduction

This training manual has been prepared to provide guidance and instruction to inspectors involved in the construction of hot mix asphalt (HMA) pavements. The important tasks involved in this work are explained and proper procedures are described.

The material is designed for use in conjunction with an introductory class for those with limited experience in HMA paving construction. It may also serve as a refresher for more experienced inspectors.

This manual has been prepared with the intent that it may be used in three ways: as a text for a training class, as a self-training manual, and as a reference to be used in the field.

The text is arranged in a fashion to help the inspector first learn the various aspects of what is involved in an HMA paving operation and then become familiar with the duties that are a part of the HMA pavement grade inspection responsibilities. This manual is not intended to cover every aspect of HMA paving. Specific operations such as aggregates, mix design, plant production, sampling & testing, etc. are covered in other training courses available through the Iowa Department of Transportation or HMA industry.

At the beginning of each section, references (shown in italics) are given to the Iowa Department of Transportation Standard Specification, Materials Instructional Memorandum (IM), Standard Road Plan, or Construction Manual section when they are applicable. These references will enable the inspector to refer to those documents for more detailed information. The actual documents are not included in this manual because they are continually being updated. Different versions may be applicable to different projects being constructed in the same construction season. The project letting date will determine which Specifications, Materials IM's, Road Standards, or other contract documents are applicable.

The Appendix (Chapter 10 of this manual) includes a glossary of common asphalt-related terminology. Many Iowa DOT-specific glossary terms may also be found in Materials IM 500.

The *HMA Paving Field Inspection Checklist*, also located in the Appendix, includes detailed information and references related to HMA project inspection duties.

Please note that all references to “HMA” would similarly apply to Warm Mix Asphalt (WMA) unless noted otherwise. WMA, which is discussed in Chapter 8, is fundamentally similar to and is considered an equal alternative to HMA.

This manual is arranged to provide space for related photographs and other illustrations adjacent to the text. The space may also be used to make notes for future reference.

### **What is hot mix asphalt?**

- Asphalt binder, aggregate, and air blended together in precise proportions to produce a mix with the desired qualities.
- There are many different types of asphalt binder and aggregates, so it is possible to combine them to make different hot mix asphalt pavements.

### **Why use hot mix asphalt?**

- Existing pavement surfaces can be upgraded relatively quickly with the least inconvenience to the traveling public.
- Maintenance repairs and surface corrections can be made quicker and cheaper than PCC pavements.
- Flexible pavement is not likely to suffer damage related to gradual settlements and movements.
- Other benefits include increased smoothness and higher contrast with pavement markings versus PCC pavements.

# **MIX PROPERTIES**



## II. Mix Properties

### Stability

Stability of a hot mix asphalt pavement is the ability to resist shoving and rutting under traffic. A stable pavement maintains its shape and smoothness under repeated loading. Stability requirements should be high enough to handle traffic, but not so high as to result in a stiff pavement that is less durable. The stability of a mixture depends on both internal friction between aggregate particles and cohesion. Internal friction relates to the shape and surface texture of the aggregate particles. Cohesion results from the bonding ability of the asphalt. Cohesion relates to asphalt binder content up to a point. Increasing the asphalt binder content beyond the critical point will reduce internal friction by creating too thick a film on the aggregate particles. The primary sources of pavement instability are excess asphalt binder in the mix, excess medium sized sand in the mix, or rounded aggregate with little or no crushed surfaces.



### Density

The density of the compacted mix is its unit weight, or the weight of a specific volume of mix. For compacted HMA, this is approximately 145 pounds per cubic foot. Density is particularly important because high density of the finished pavement is essential for long term pavement performance.

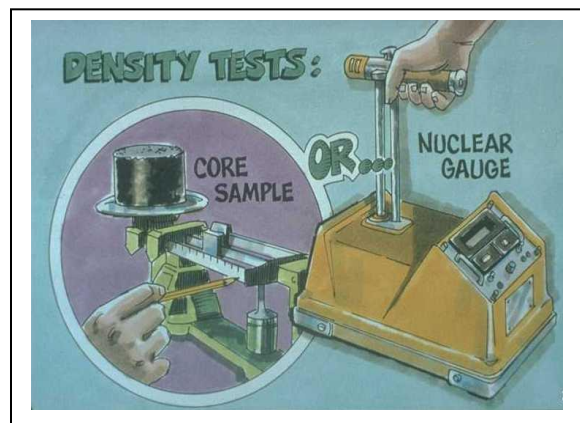

## Chapter 2

---

Laboratory density of a specific mix is essentially the maximum density for the mix and is the standard by which field compaction is measured. Field densities and specification limits are expressed as a percent of laboratory density.

### **Workability**

Workability describes the ease with which a paving mixture can be placed and compacted. “Harsh” mixes contain a high percentage of coarse aggregate, have a tendency to segregate with handling, and may be difficult to compact. “Tender” mixes are too easily worked or shoved and may be too unstable to place and properly compact. Tender mixes may be caused by a shortage of mineral filler, too much medium sized sand, smooth or rounded aggregate particles, too much moisture in the mix, and/or too high of mix temperature.



### **Flexibility**

Flexibility is the ability of a hot mix asphalt pavement to adjust to gradual settlements and movements in the subgrade without cracking. Since virtually all subgrades either settle (under loading) or rise (from soil expansion), flexibility is a desirable characteristic for all hot mix asphalt pavements. An open-graded mix or one with higher asphalt binder content is generally more flexible than a dense-graded mix or one with lower asphalt binder content.

## Chapter 2

---

Sometimes the need for flexibility conflicts with the need for stability, so that trade-offs must be made in selecting the optimum asphalt binder content.

### **Durability**

The durability of a hot mix asphalt pavement is its ability to resist disintegration by weathering and traffic. A lack of durability can result in aging or oxidation of the asphalt binder, disintegration of the aggregate, and stripping of the asphalt film from the aggregate. Thick asphalt films provide durability benefits in that they do not harden and age as thin films do and tend to seal the pavement better so as not to allow large volumes of air and water to penetrate the mat. A dense gradation of sound, tough, strip-resistant aggregate contributes to pavement durability by creating better particle interlock and minimizes disintegration and raveling of the pavement.



### **Impermeability**

Impermeability prevents the passage of air and water into or through the asphalt pavement. This characteristic is directly related to the void content of the compacted mixture. Even though void content is an indication of the potential for passage of air and water through a pavement, the character of the voids is more important than the number of voids. The size of the voids, whether or not they are interconnected, and the access of the voids to the pavement surface, all determine the degree of impermeability.



### **Fatigue Resistance**

Fatigue resistance is the pavement's resistance to repeated bending under wheel loads (traffic). Air voids and asphalt binder viscosity has a significant effect on fatigue resistance. As air voids in the pavement increase, either by design or lack of compaction, fatigue resistance is reduced. Likewise, a pavement containing asphalt that has aged and hardened significantly has reduced resistance to fatigue. The thickness and strength characteristics of the pavement and the support of the subgrade also play a role in determining pavement life and preventing load-associated cracking.

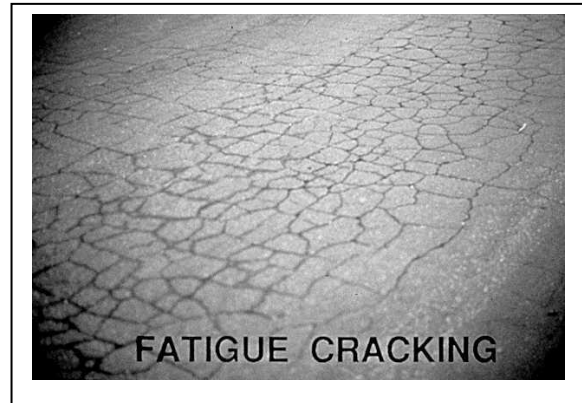

### **Skid Resistance**

Skid resistance is the ability of a hot mix asphalt pavement surface to minimize skidding or slipping of vehicle tires, particularly when wet. The best skid resistance is obtained by a rough-textured aggregate in a relatively open-graded mixture. Aggregates that tend to "polish" smooth under traffic have poor skid resistance. Flushing or bleeding of excess asphalt binder in the mix to the pavement surface can create serious skid resistance problems.



### **Smoothness**

Smoothness of the finished riding surface is considered the most important pavement property to the travelling public. The smoothness of primary and interstate pavements contributes to travelers' overall perception of the state.

## Chapter 2

---

Smooth pavements are generally safer, last longer, and cause less wear and tear to the vehicles they carry.

HMA pavement smoothness is adversely affected by a number of factors, including variations in paver speed and general lack of uniformity in the paving operation, improper aggregate gradations, improper operation of trucks, poor joint construction practices, and poor grade controls.

Since contractors may receive smoothness incentive payments (or price reductions) based on the relative smoothness of the pavement, it is in their own best interests to control their operations in a manner that produces pavements that are as smooth as possible.



### **Asphalt Binder Content**

The asphalt binder content in the mixture is critical and must be accurately determined in the laboratory and precisely controlled on the job. It is usually expressed as a percentage, by weight, of asphalt binder in the mix. For our purposes, it is the amount of asphalt binder that effectively forms a bonding film on the aggregate surfaces.

The optimum asphalt binder content of a mix is highly dependent on aggregate gradation and absorption. A finer mix gradation has a larger total surface area, thus requiring a greater amount of asphalt binder to effectively coat the particles. Conversely, coarser mixes have less total aggregate surface area



## Chapter 2

---

and demand less asphalt binder to coat particles. Highly absorptive aggregates increase the quantity of asphalt binder required to satisfy mix demands.

### Air Voids

Air voids are small pockets of air between the coated aggregate particles in the final compacted mix. The durability of a hot mix asphalt pavement is a function of the air void content. An air void content that is too high provides passageways for the entrance of damaging water and air into the mat. An air void content that is too low can lead to “flushing” under compaction by traffic. Flushing is a condition in which excess asphalt binder squeezes out of the mix onto the pavement surface, since there are not enough voids in the pavement to accept the displaced asphalt binder. A mix that is too low in air voids can also be prone to rutting under traffic and temperature extremes.

Density and air void content are directly related (inversely):

Higher Density → Lower Air Voids  
Lower Density → Higher Air Voids



# **EQUIPMENT**

### III. Equipment

#### **Brooms**

*(Specification 2001.14)*

Brooms are used for cleaning and preparation of base pavement. They provide a surface free of foreign material, which increases the bond between the existing pavement and HMA resurfacing. Brooms shall be of the rotary type, and the broom shall be driven by an auxiliary motor or by a power takeoff (PTO) from the power plant of the unit propelling the broom.



Some brooms are equipped with water spray bars, to help control fugitive dust generated during sweeping. In other (typically urban) situations, a "street sweeper" unit with an on-board dust and dirt collection system may be utilized.



#### **Tack Distributor**

*(Specifications 2001.11 & 2001.12)*

Tack distributors shall be mounted on motor trucks or trailers. Distributors shall be equipped with adequately sized burners for heating the bituminous material and with a means of circulating the material when the burners are in operation. Each unit shall be equipped with an accurate thermometer for indicating the temperature of the bitumen in the tank. The distributor shall be capable of distributing bitumen at specified rates ranging from 0.03 to 0.07 gallons per square yard. The size of the spray nozzles shall be such that bitumen may be spread in a uniform coating without the forward speed exceeding 20 mph.





## Chapter 3

---

The spray bars must be adjustable for the widths of application required by the work.

The contractor shall provide the manufacturer's instructions for each distributor, including specific recommendations for the following:

- Spray bar height above road surface.
- Nozzle size and angle of spray fan with spray bar axis.
- Tables showing rates of distribution for corresponding tachometer readings, spray bar pressure, or pump revolutions, and for various widths of spray bars.

The tanks of all distributors shall either be calibrated or have the manufacturer's calibration verified by appropriate testing firm/agency before initial use, and after any damage or alteration which may affect the calibration.



### **Trucks**

*(Specifications 2001.01 & 2001.03)*

Various types of trucks are used to deliver hot mix asphalt to the job site. The two most common types used are end-dump trucks and bottom-dump trucks. End-dump trucks deposit their loads directly into the paver hopper. Bottom-dump or "belly-dump" trucks deposit the hot mix in a windrow in front of the paver. Other types of hot mix delivery equipment include semi-trailer dump trucks and horizontal discharge (also called "flow-boy" or live-bottom) trailers.

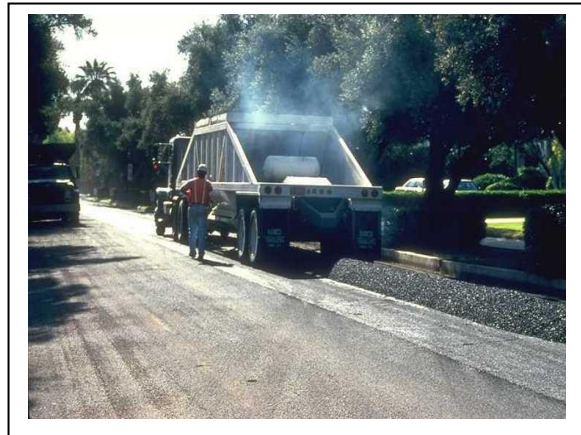

## Chapter 3

Hot mix asphalt must be transported in trucks with tight metal or metal-lined dump bodies.

For hot mixes on unusually long hauls or for work after October 1, the Engineer may require the truck bodies to be insulated to retain heat in the mixture. The insulation must be solidly attached to vertical sides only, with no broken or worn-through sheets allowed. All trucks are required to be equipped with canvas covers (tarps) which are recommended for use in all situations involving cool weather, long haul distance or hauls at highway speeds.

Truck bodies are to be kept clean by heating, scraping, or by use of an approved release agent described in *Materials IM 491.15*.

When kerosene, distillates, or other solvents are used, the trucks must be allowed to drain for a minimum of 5 hours before further use to transport asphalt mixtures.

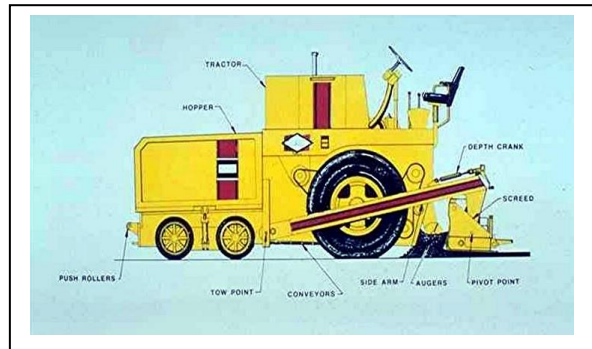

### **Paver**

*(Specification 2001.19)*

Pavers are machines designed to place and initially compact an HMA mixture on the roadway to a specified depth. The paver must be self-propelled for laying widths of 8 feet or more and mounted on crawler treads or pneumatic tires. The paver shall be designed to pass over small irregularities in the existing base without sharp vertical movements. The two major parts of a typical HMA paver are the tractor unit and the screed unit.



## Chapter 3

---

### Tractor Unit

The tractor unit provides the moving power for paver wheels or tracks and for all powered machinery on the paver. In operation, the tractor unit's power plant propels the paver, pulls the screed unit, and provides power to other components through various transfer devices.

### Screed Unit

The screed unit has two major functions. It strikes off the mix in a manner that meets specifications for thickness and smoothness, and it provides initial compaction of the mixture. The screed unit shall be attached to the tractor unit in such a manner that it is free floating on the mixtures being placed.

The screed must have vibrators and run at the frequency recommended by the manufacturer. Vibrators have essentially replaced the tamper bars found on earlier pavers, though a few models may be equipped with both. Screed extensions may be used, provided each has a screed plate with vibration. If the screed is extended more than one foot, the augers must also be extended.

The paver must be equipped with automatic screed controls to regulate mat thickness and crown shape. The automatic controls shall have grade and slope control systems, which are required to work in conjunction with a ski-type device, traveling stringline, or other approved grade referencing system.

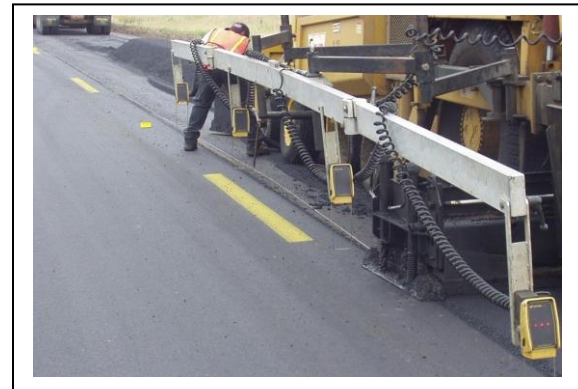

### **Rollers**

*(Specification 2001.05)*

Self-propelled rollers are required for the compaction of hot mix asphalt. Typical self-propelled compaction rollers consist of the following types:

#### **Vibratory Rollers**

Self-propelled vibratory rollers provide compactive force by a combination of weight and vibration of their steel drums. Vibratory rollers achieve compaction through a combination of three factors: dead weight, impact forces (roller vibration), and vibration response in the mixture. To ensure smoothness under vibratory compaction, the frequency (the number of vibrations or downward impacts per minute) and the roller speed should be matched to result in a minimum of 10 impacts per linear foot. The manufacturer's handbook should be available to the operator. Water spray bars and wetting pads are used to prevent adhesion to the drums. Scraper bars are also utilized to remove any particulate matter that may build up on the drum.



#### **Pneumatic-Tired Rollers**

Self-propelled, pneumatic-tired rollers have rubber tires instead of steel tires or drums. They generally feature two tandem axles, with 3 to 4 tires on the front axle and 4 to 5 tires on the rear axle. The wheels oscillate; that is, they move up and down independently of one another. The tires must be no smaller than the 7.50 X 15 size. Tire pressures must not vary by more than 5 psi. The rollers must be capable of producing contact pressures of 80 psi with a legal axle load. The roller shall be equipped with wheel sprinklers, scrapers, mats and, during cooler



## Chapter 3

---

weather, protective skirting around the tires to retain heat.

### **Smooth Steel-Wheeled (Static) Rollers**

Self-propelled, smooth steel-wheeled static rollers may be three-wheel type, two axle tandem type, or a vibratory steel roller operating in static mode.

The driving roller must not be less than 60 inches in diameter. On tandem type rollers, the driving drum shall be capable of being filled with liquid ballast. Water spray bars and wetting pads are used to prevent adhesion to the drums. Scraper bars are also utilized to remove any particulate matter that may build up on the drum.



### **Windrow Pickup Elevator**

*(Construction Manual section 8.80)*

Use of windrow pickup equipment has become a common procedure in Iowa. With this process, hot HMA is placed in a windrow onto the existing pavement surface using bottom dump trailers. A windrow pickup elevator picks up, elevates, and deposits the material into the paver hopper. The primary advantages of this method are contractor efficiency, uniform speed of the operation, and elimination of delivery trucks bumping into the paver.



The contractor must balance HMA delivery with mat placement rate to keep the paver hopper at a uniform level, which helps avoid segregation. Balancing mix delivery and placement minimizes the need to either feed the hopper additional mix or remove excess mix from in front of the machine. It is also important that the contractor picks up all windrow material from the



## Chapter 3

---

pavement surface and not allow the windrow to extend more than two truckloads in front of the paver to avoid excessive cooling of the mix.

Windrow length must be shortened if paving during cool or windy conditions. The windrow pickup process can be used successfully for the lower lift of a full depth pavement; however, it is important to make sure the pickup machine does not disturb (pick up) the subgrade or subbase material.



### **Material Transfer Vehicle (MTV)** *(Construction Manual section 8.80)*

Material Transfer Vehicles (MTV's) provide mix surge capacity, which allows more constant paver speed and a more efficient paving operation. These vehicles operate in front of or beside the paver and receive loads of hot HMA from delivery trucks. An MTV operates as a mobile HMA surge bin that remixes the HMA and continually feeds the paver hopper. Use of this vehicle results in a smoother pavement by minimizing paver stops and eliminating trucks bumping into the paver. Segregation is virtually eliminated, and a more uniform surface and pavement density is typically achieved.



The main disadvantage of MTV's is weight. The equipment is very heavy and may exceed the load-carrying capacity of the bridges over which it must travel. Before an MTV can be used on a DOT project, approval must be received from the Bridges and Structures Bureau. The contractor must initiate the approval process through the Resident Construction Engineer's office,



## Chapter 3

---

preferably no later than at the preconstruction conference.

The approval may be subject to load (hopper level) restrictions, depending on results of the analysis of existing bridge structures. By default, the MTV hopper level must be properly managed to result in a near empty condition when crossing all structures. In addition, the MTV must cross down the centerline of structures, operating at a speed of no more than 5 miles per hour.

Applicable permits must be obtained for moving the vehicles to and from the project on the open highway, to ensure compliance with Code of Iowa weight laws.

MTV use must be closely monitored and discontinued if evidence of detrimental distress in the base or underlying pavement is observed. Such distresses would typically show up as deformation / rutting of base in full depth paving or cracking and joint movement in existing pavement during an HMA overlay. The contractor is responsible for repairing any damage to existing pavement or base caused by MTV operation.



### **Mat Smoothness Machine**

*(Construction Manual section 8.80)*

Mat smoothness machines are similar to MTV's, but on a smaller scale. They consist of an HMA receiving hopper and elevator that deposits hot HMA into the paver hopper. Mat smoothness machines typically are pushed by the paver and do not require a separate operator. This can be a drawback, however, in that additional skills are required on the part of the paver



## Chapter 3

---

operator in order to successfully steer the unit being pushed ahead of the paver.

Use of a mat smoothness machine allows for more consistent paver operation, by providing some surge capacity for the paver.

It can also help remix the material and minimize segregation effects. Weight restrictions are usually not a concern with this piece of equipment.



# **ROLE OF THE INSPECTOR**

## IV. Role of the Inspector

### **Description**

*(Specification 1105.07; Construction Manual section 3.01)*

Inspection is one of the most important processes in any highway project. The quality of the finished product generally reflects the quality of the inspection performed.

An inspector must be honest and fair, exercising responsibilities with firmness and good nature. Inspectors must work cooperatively with fellow employees, supervisors, and contractors to promote the progress of the project. The inspector needs to be familiar with the construction schedule and know how the work to be inspected fits into the overall schedule.

### **Responsibilities**

Inspectors are accountable to the project engineer for satisfactory performance of their duties. The primary responsibilities for an inspector include:

- Plan Familiarity
- Work Done Without Inspection
- Contract Compliance
- Unacceptable Work
- Testing
- Daily Diary

### **Authority**

Inspectors have the authority to reject materials or suspend work if the quality of either is in dispute with the contractor. The project engineer decides settlement of a dispute. The grade inspector should immediately inform their

## Chapter 4

supervisor and the contractor of any materials or work they feel is outside of specification limits. The actual decision to reject materials or suspend work would come from a higher level of authority, typically the project engineer, following discussions with the inspector and contractor.

The inspector's authority does not extend to modification of any of the provisions of the contract documents, approval or acceptance of the work, supervising the contractor's work operations, or performing any other activity that is the responsibility of the contractor.

### **Important Documents** *(Specification 1105)*

#### **Proposal**

Proposals are supplied to the contractors upon request for the purpose of bidding on the work proposed. Some of the information listed on the proposal includes:

- Items of work to be performed on the project.
- Estimated quantities for each item of work.
- Proposed work period.
- Supplemental specifications, special provisions, and special notes, applicable to the project.
- Special job mix requirements for the project.

Proposals are subject to Addendums that may alter the work originally proposed (make sure you have all of the addendums).

```
ESTIMATING PROPOSAL -- FOR NON-FEDERAL AID CONTRACT PAGE: 1
To be valid for bidding, the Proposal Schedule of Prices form
Included with this Estimating Proposal or a computer generated RBS
Schedule of Prices form must be included with a "BIDDING DOCUMENT"
Issued by the IOWA D.O.T., Office of Contracts.
*****
A Proposal ID No.: 12-0033-053 Bid Order No.: 152 A
A Primary County: BUTLER Locating Date: July 14, 1998 A
A Type of Work: ACC RESURFACING Design: METRIC A
A Bid Goal: None 1995 Std Spec A
A Pre-Qual Group: ACC PAVEMENT/RESURFACING A
A Contracting Authority: IOWA DEPARTMENT OF TRANSPORTATION A
A Proposal Guaranty: $ 150,000.00 A
A Bid Proposal Package: None assigned to, or allowed with this Bid Order. A
*****

This Proposal Includes The Following Project(s):

Project: STPH-3-5(23)--23-12 County: BUTLER
Work Type: ACC RESURFACING / HEATER SCARIFICATION Plans: Yes
Route: IOWA 3 Design: METRIC
Location: FROM JUST EAST OF THE JCT. WITH IOWA 188, EASTWARD TO THE
WEST JCT. WITH U.S. 219 IN MAVERLY IN BREWER COUNTY.
Road System: PRIMARY ROAD (non-MS) Milepost: 210.59 To 220.19
Length: 16.25 Kilometers A
Non-Federal Aid - Predetermined Wages Are Not In Effect

Project: STPH-3-5(23)--24-12 County: BUTLER
Work Type: ACC RESURFACING Plans: Yes
Route: IOWA 3 Design: METRIC
Location: FROM JUST EAST OF THE EAST JCT. WITH IOWA 188, EASTWARD TO
JUST EAST OF THE JCT. WITH IOWA 188.
Road System: TRUNK ROAD (non-MS) Milepost: 202.62 To 210.59
Length: 12.58 Kilometers A
Non-Federal Aid - Predetermined Wages Are Not In Effect

Project: RP-16-2(703)158--16-18 County: GRUNDY
Work Type: ACC RESURFACING Plans: No
Route: IOWA 18 Design: METRIC
Location: FROM NEAR THE SOUTH JCT. OF U.S. 30, NORTHERLY TO THE ELUD
COUNTY LINE.
Road System: MAINTENANCE Milepost: 138.38 To 170.43
Non-Federal Aid - Predetermined Wages Are Not In Effect
```

Line No.	Item Number	Description	Quantity and Unit	Unit Price	Bid Amount
0130	12000000	ASPHALT CEMENT CONCRETE BASE, TYPE B CLASS 1, 4.5% MINIMUM PARTICLES	2,277.0000 AC	29.930000	77,063.98
0130	12000000	CEMENT CONCRETE SURFACE (CONCRETE TYPE B, 2% OR MORE 75# CHINA#1 PART, 5% CHINA#10, FINE#10)	15,177.0000 SQ	15.370000	233,229.49
0140	12000000	ASPHALT CEMENT	1,048.0000 TON	149.000000	155,154.00
0150	20000000	ASPHALT CEMENT LUMPS (1) FRYBLEN SAMPLES	LUMP	LUMP	2,000.00
0160	10000000	HEAVY METALLIC BY HEATER SCARIFICATION	110,413.0000 SQ	0.718000	79,275.83
0170	10000000	HEAVY METALLIC BY HEATER SCARIFICATION, CLASS A CONCRETE STONE	6.0000 SQ	20.000000	120.00
0180	2401-100000	REMOVAL OF EXISTING STRUCTURES	LUMP	LUMP	200.00
0190	2401-200000	REMOVAL OF EXISTING ROADWAY	LUMP	LUMP	1,800.00
0200	10000000	RETRACTED CONCRETE SANDWICH BEARING	416.4460 A	105.000000	43,745.50
0210	10000000	CONCRETE SANDWICH BEARING	100.5000 A	98.000000	9,845.00
0220	10000000	CONCRETE SANDWICH BEARING	9.4000 A	128.000000	1,203.20

## Chapter 4

### Contract

The contractor and the contracting authority enter into a contract after the acceptance of the bid. It obligates the contractor to perform the work as outlined in the proposal. The contract lists the unit prices and extended prices for all items of work outlined in the proposal.

### Project Plans

Project plans show the location, character, dimensions, and details of the work to be performed. The plans generally include typical drawings, plan notes, standards, and supplemental drawings. Also included are traffic control plans, layouts, and standards.

Plans are subject to revisions (make sure you have all of the revisions).

### Standards

Standard Road Plans show standardized design features, construction methods, and approved materials for performing various items of work on a project. Tabulation 105-4, on the plans title sheet, lists the applicable road standards for the project.

The standards are referenced by number and revision date (make sure you have the correct version the plans refer to).

### Specifications

Specifications represent the minimum requirements for performing the work of the contract. Specifications outline how the items of work are to be measured and on what basis payment will be made. The specifications for a project include the current Standard Specification Series (hardbound book) and General Supplemental Specifications (GSS), as well as any

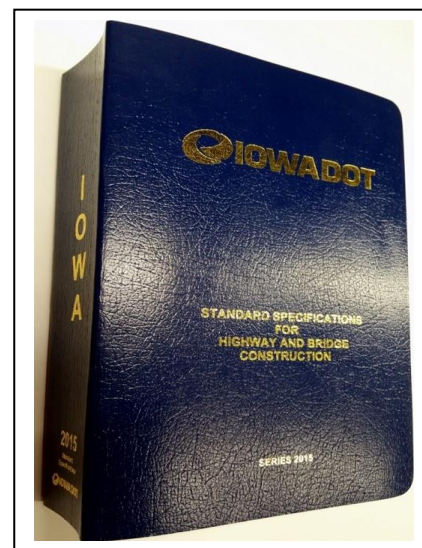
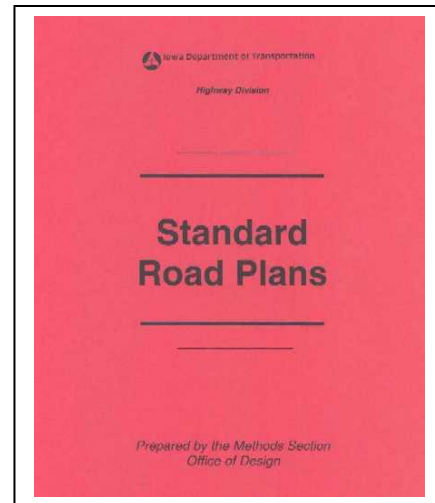
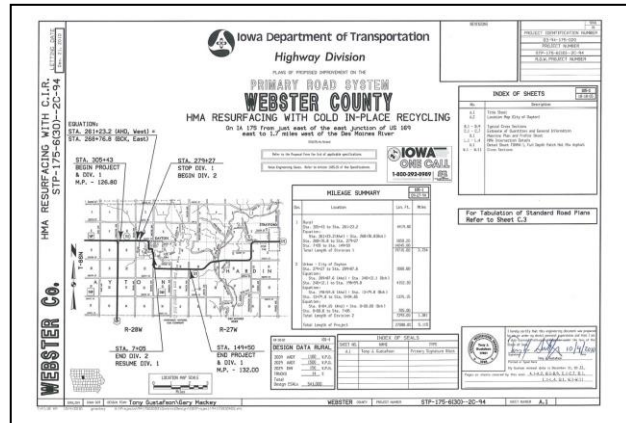

## Chapter 4

Supplemental Specifications (SS) or Developmental Specifications (DS) outlined on the proposal.

### Special Provisions

Special Provisions (SP) are additions and amendments to the Standard and Supplemental Specifications covering conditions peculiar to an individual project.

### Instructional Memorandums

Materials Instructional Memorandums (IM's) are guidelines and instructions for the testing and acceptance of construction materials.

### Construction Manual

The Construction Manual provides background information, required procedures, current instructions, and other departmental policy for uniform administration and inspection of construction projects. The manual is not considered a part of the contract documents for a project.

It is important to become familiar with the various contract documents, and the role they play in administering the project. It is also essential to understand how the contract documents are coordinated and their relative order of importance in case discrepancies or conflicts exist between documents.

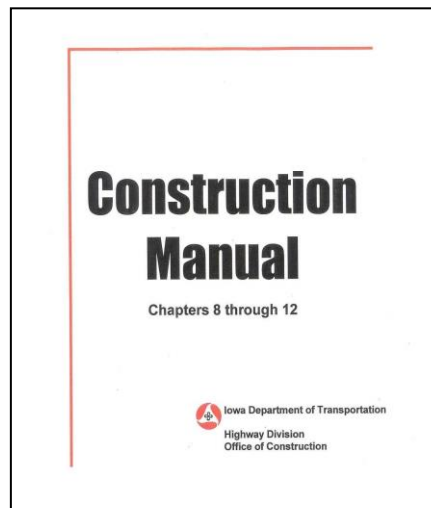
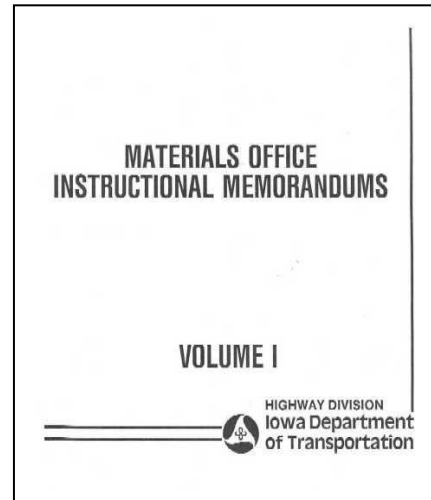
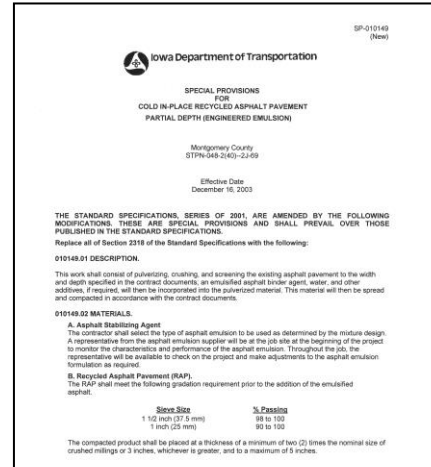

### Hierarchy of Contract Documents

In case of a discrepancy between contents of the contract documents, the following items listed by descending order shall prevail:

1. Addendum
2. Proposal Form
3. Special Provision
4. Digital Contract Files. Shall apply only when digital files are available and the Contractor uses automated machine control guidance.
5. Plans
6. Standard Bridge Plans, Standard Culvert Plans, and Standard Road Plans
7. Developmental Specifications
8. Supplemental Specifications
9. General Supplemental Specifications
10. Standard Specifications
11. Materials I.M.
12. Notice to Bidders

This list is also found in General specifications 1105.04.A.

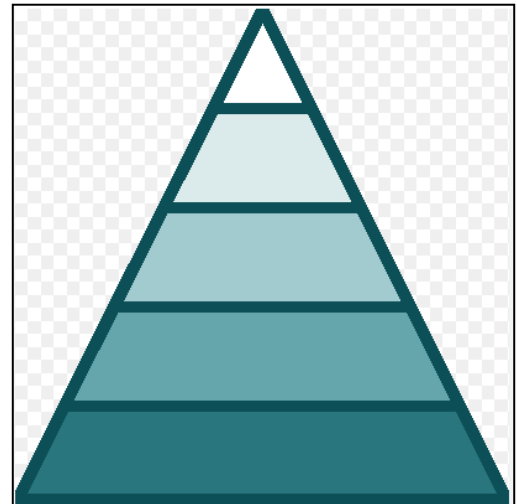
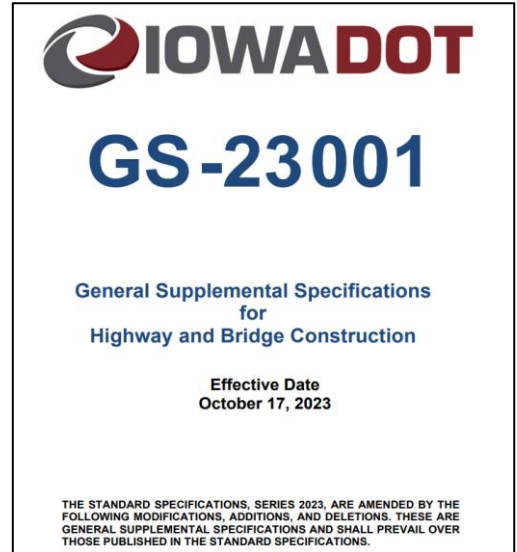

### **Duties Typically Performed**

*(Construction Manual Chapter 3;  
Materials IM's 204 & 511)*

#### **Checking**

Checking includes reviewing the project plans, preparing field books, and acquiring a working knowledge of the specifications that apply to the project.

#### **Observing**

Observing is done continually to insure compliance with the specifications. Thorough checking and diligent observation will result in good inspection. Some of the typical items to be observed include:

- Roadway Preparation
- Handling of Mix
- Equipment
  - Type & Features
  - Operation of Equipment
- Traffic Control
- Safety

#### **Collecting Material Truck Tickets**

Inspectors are responsible for making sure the material delivered to a project is the correct mix and meets current plans and specifications.

Things to look for on the truck tickets include:

- Type of material
- Date
- Project Number
- Contractor name
- Truck status times (load, left plant, arrive etc.)
- Gross weight
- Tare weight
- Net weight
- Mix design number



### Collection/Receive Electronic Tickets

Some projects are providing electronic tickets in lieu of paper tickets. This is a newer technology that is supposed to help the contractor and inspector to send and receive tickets in real time without collecting and filing paper tickets. Currently there is a developmental specification (DS-23032) for electronic ticketing. Any project with the DS attached will be required to provide the inspector with electronic tickets. DS-23032 is attached in the appendix (Chapter 10 of this manual)



### Sampling

Sampling and testing of materials are a very important part of construction work. Payment for many items of work is based on the compliance of tests performed on material that has been sampled.

Most project sampling is performed by contractor personnel, as directed and witnessed by the inspector or plant monitor. The timing and frequency of sampling is as stated in *IM 204*. Sampling procedures shall conform to applicable Materials IM's.



There is some project sampling that will be performed by District Materials Office personnel. They should be informed when that material will be available for sampling so it can be tested in a timely





## Chapter 4

---

### Testing

Testing of materials to be incorporated into the project may be performed by the contractor, District Materials Office personnel or by the inspector / plant monitor, depending on the material type, nature of the testing, and project staffing. Testing requirements and responsibilities are shown in *IM 204* and *IM 511 Appendices*. Testing procedures are found in applicable Materials IM's, or as directed by other contract documents.

All personnel involved in project sampling and testing shall have received the appropriate level of training and maintained all certifications required to perform their duties. The minimum required certification level is shown in *Construction Manual Appendix 3-4*.

*See Chapter 8 of this manual for additional information regarding HMA sampling and testing duties.*

### Documentation and Reporting

Complete documentation of all phases of the work is necessary. Good records of each item must be kept to document payment to the contractor. Some items to keep in mind:

- Keep complete, neat, accurate and up to date records and reports.
- Submit reports on time.
- Include lineal, quantitative, and unit count measurements to support pay quantities.
- Complete diary (You can never have too much information in the diary. Information found in a diary is useful to recreate events in the future).
- Daily traffic control records. For projects let under Traffic Quality



## Chapter 4

---

Control specifications, this is a contractor responsibility.

- Inform other inspectors and/or supervisor of any irregularities.

### Other Inspection Duties

- Check Contractor's Equipment
  - Type, Size & Features
  - Operation
  - Maintenance
  - Safety
- Check Material Certifications
- Check Dimensions
  - Width
  - Depth
  - Length
  - Alignment
- Check Quantities and Yields
- Check Traffic Control Setup
  - For projects let under Traffic Quality Control specifications, this is typically a contractor responsibility.
- Check Temperatures
  - Existing pavement surface
  - Mix (Plant & Grade)
- Check Mix Uniformity
  - Temperature
  - Segregation
  - Aggregate Clumps
- Direct and Witness Sampling
  - Aggregate (Cold-feed)
  - Asphalt Binder
  - Loose Hot Mix (Hot box)
  - Compacted Hot Mix (Density Cores)
    - Determine and layout density core locations.
    - Direct and witness core drilling.
    - Measure and inspect cores for defects.
    - Take possession of cores & deliver to field lab for testing (maintain

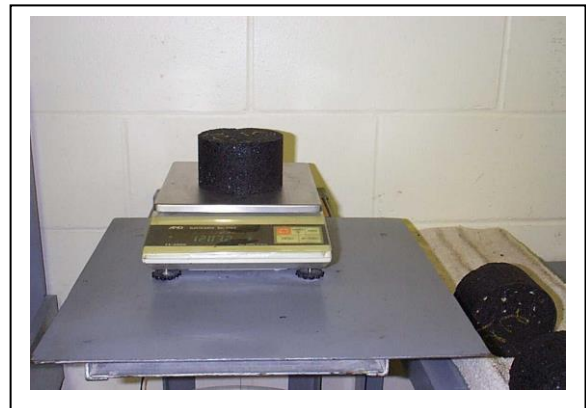

- agency chain of custody).
- Identify Samples
- Secure Samples (to be transported by others)
- Perform Testing
  - Compacted Hot Mix (Density Cores)
    - Perform density testing on HMA core samples.

These are some of the typical duties that the inspector will be asked to perform. Knowledge of job requirements and an interest in the work will contribute immensely to performing the duties of an inspector.

*Additional detailed information and references related to HMA project inspection duties may be found in the HMA Paving Field Inspection Checklist, located in the Appendix (Chapter 10).*

# **TRAFFIC CONTROL**

## V. Traffic Control

→ Please note the following Traffic Control information is included here for general information purposes only. See related training courses, specifications, and contract documents for the latest requirements.

### **Flagger**

(Specification 2528; MUTCD - Part 6)

Since flaggers are required for most traffic control situations, the importance of their duties and responsibilities must be stressed. Flagger operations, equipment, and apparel shall conform to the current Iowa DOT *Flagger's Handbook*. Copies of the Flagger's Handbook are available from the Iowa DOT and should be distributed to flaggers and inspectors.

A flagger's primary duties are to:

- guide traffic safely through work areas
- protect fellow workers
- prevent unreasonable delays for motorists
- answer motorist questions knowledgeably

### **Rules of Conduct**

- Flaggers should be neat in appearance.
- Conversations with the public should be polite. Do not engage in small talk or argue with vehicle occupants.
- Make sure to use the proper sign and flagging position for the situation.
- Stand alone. Do not mingle with the work crew or traveling public. Remain standing at all times and never turn your back on traffic.



## Chapter 5

---

- Do not leave your position for any reason unless relieved.
- Stay alert. Don't be distracted by the work operation.

### Equipment

All personnel in the highway right-of-way shall wear ANSI 107 Class 2 apparel at all times when exposed to traffic or construction equipment.

- ANSI 107 Class 2 vest, shirt, jacket or raingear.
- Soft cap meeting ANSI 107 headwear requirements. A hard hat in the same colors is an acceptable alternative to the soft cap and may be required in certain situations.
- For nighttime operations, additional clothing requirements include ANSI 107 Class E pants. Flaggers should also consider wearing highly visible retro-reflectorized wristbands or gloves. Nighttime equipment includes flashlight with red glow cone and lighted flagger station.
- A standard combination STOP/SLOW staff-mounted paddle sign with approved retroreflective sheeting.
- Red Flag (optional) - permitted only when stopping traffic in combination with the STOP/SLOW sign, or in emergencies when standard signs are not available.

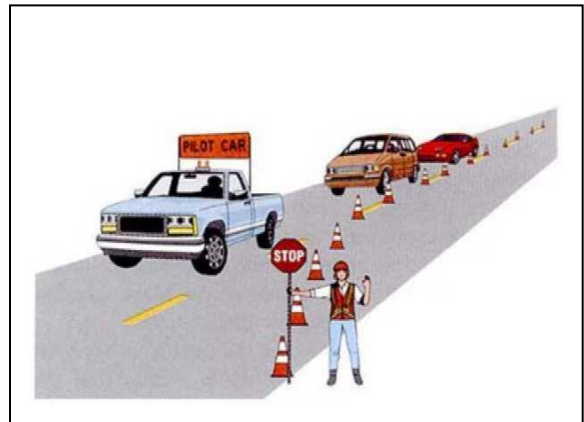

### Methods & Procedures

- For a pilot car situation, the flagger should stop the first vehicle while positioned on the shoulder adjacent to the lane being stopped. Do not stand in the path of an approaching vehicle.

## Chapter 5

- After the first vehicle has stopped, the flagger will move to the centerline position and stop succeeding vehicles from that position.
- To release traffic, return to position on shoulder and signal drivers to proceed into the open lane.
- Methods and procedures for other situations are addressed in the Flagger's Handbook.

### Traffic Quality Control

Flaggers shall be trained about safe flagging operations that comply with the Iowa DOT Flagger's Handbook, the *MUTCD - Part 6*, and the Standard Specifications prior to flagging operations. Training of flaggers shall include the following:

- Issue and review the Iowa DOT Flagger's Handbook.
- Presentation of the current Iowa Professional Flagging Video.
- Issue Flagger Training Card (Flaggers shall carry their card at all times and show it upon request).
- Contractor shall maintain a list of the flaggers trained and the date of training.

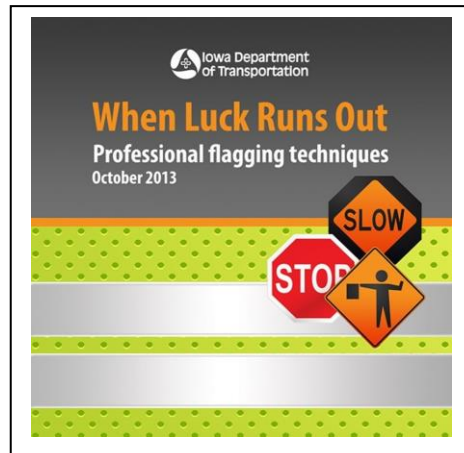

### Standards

*(Standard Road Plans TC- series)*

Standard Road Plans required for the project are listed by number and date in Tabulation 105-4 on the title sheet of the plans. The most common traffic control (TC-series) standards used on hot mix asphalt paving projects include:

## Chapter 5

### TC-202 Shoulder Closure (One-Lane)

Traffic control layout for work located less than 15 feet from the traffic lane that does not require a lane closure.

### TC-213 Lane Closure with Flaggers

Traffic control layout for a lane closure less than ¼ mile in length.

### TC-214 Lane Closure with Flaggers For Use with Pilot Car

Traffic control layout for a lane closure greater than ¼ mile in length.

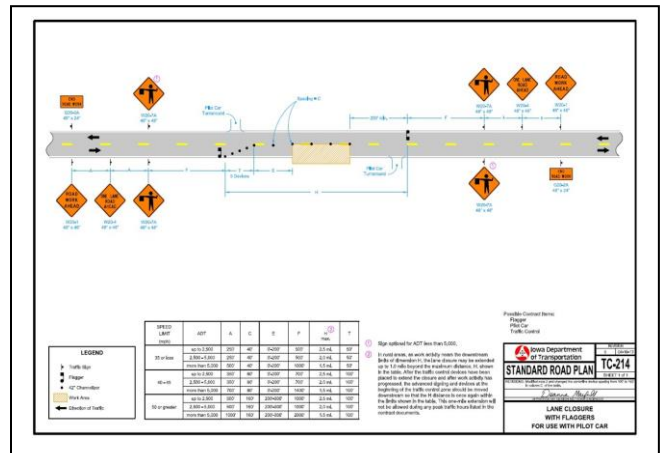

### TC-282 Uneven Lanes (2-Lane)

Traffic control layout to address centerline drop-off for design lift thickness 2" or less (without centerline fillet) and design lift thickness greater than 2" (with centerline fillet).

### TC-418 Lane Closure on Divided Highway

Traffic control layouts for right lane and left lane closures on divided highway.

### TC-419 Lane Closure on Undivided Highway

Traffic control layouts for right lane and left lane closures on a four-lane undivided highway.

### TC-420 Lane Closure at Ramps

Traffic control layouts for right lane and left lane closures through entrance ramp tapers.

### TC-482 Uneven Lanes (4-Lane)

Traffic control and pavement marking layouts to address centerline drop-off on 4-lane divided highways.

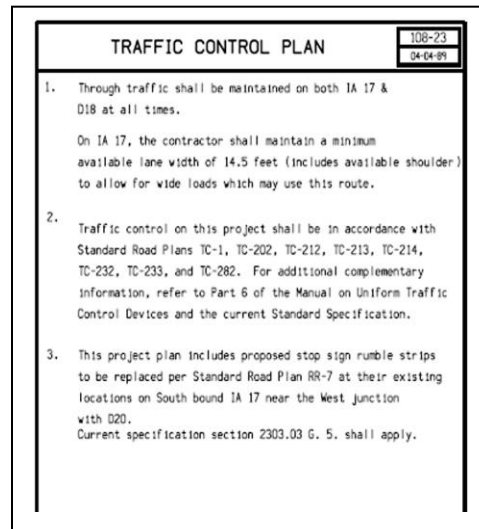



## **Plan Notes & Detail Plan Sheets**

*(Specification 2528)*

Traffic Control Plan (Tabulation 108-23) is included in the plans to provide special instructions such as whether traffic is to be maintained through the work area, staging sequence, storage of contractor's equipment and materials, responsibility for signing, etc. Review the project plans for traffic control notes and study special Detail Sheets to become familiar with specific traffic control requirements for the project. Please note that many common traffic control notes previously included in the plans are now found in *Section 2528* of the standard specifications.



### **Traffic Quality Control**

The Contractor must monitor traffic operations and submit proposed Traffic Control Plan changes to the Engineer for approval prior to changes being made. The Contractor must coordinate all changes to the Traffic Control Plan and coordinate all traffic control operations, including those of subcontractors and suppliers.

### **Traffic Control Devices**

*(Specifications 2528 & 4188; MUTCD - Part 6)*

All traffic control shall be in accordance with the current edition of the *MUTCD - Part 6*, as adopted by the Iowa DOT. Traffic control devices shall meet the applicable NCHRP Report 350 criteria for the category of device in question. The device categories and requirements are explained in *Specification Article 2528.01*.



### Signs

Signs shall be of the size and type shown in the contract documents and shall utilize retroreflective sheeting meeting requirements of *Specification Article 4186.03*. Signs for traffic control zones in duration of four calendar days or more shall be mounted on fixed posts. For duration less than four days, signs may be mounted on fixed posts or movable skids. Signs must be properly positioned and maintained in a condition so that the message is clearly readable when viewed from a vehicle. Gender specific signs, such as FLAGMAN and MEN WORKING, are not allowed. Signs shall either be neutral gender, such as FLAGGER, or equivalent symbol signs.

### Channelizing Devices

Channelizing devices shall be of the type shown in the contract documents. *Specification Article 2528.03, C*, gives specific requirements for Type I, Type II, and Type III Barricades, situations for their respective use, and allowable substitutions. Cones, vertical panels, drums, and tubular markers shall meet the current requirements of the Manual on Uniform Traffic Control Devices (MUTCD) and *Specification Section 4188*. Cones may be used as channelizing devices during daylight hours only. Different channelizing device types are not to be intermixed on a project. Channelizing devices may be placed up to 2 feet beyond centerline or lane line at specific locations where actual work activity is taking place. Devices must be returned to original position when work activity has passed. Channelizing devices may be omitted during work hours in areas where placement interferes with work.



### **Pilot Cars**

Pilot cars shall be pickup trucks or automobiles carrying the Contractor's company insignia, equipped with G20-4 signs reading: PILOT CAR - FOLLOW ME. The bottom of the signs shall be mounted at least one foot above the top of the vehicle's roof.

The message must be clearly visible from both in front of and behind the vehicle. Pilot cars shall be operated to maintain an appropriate uniform speed through the work area, no greater than 40 miles per hour.



### **Temporary Barrier Rail**

Temporary barrier rail requirements are included in the plans or other contract documents. Unless otherwise shown, precast concrete units shall be used.

### **Temporary Traffic Signals**

Traffic signal requirements are shown in the contract documents. Traffic signal details are included in Part 6 of the MUTCD. Actuated signal controllers are to be provided. All signal heads mounted over traffic shall be centered over the appropriate traffic lane. Clearance for overhead wiring shall be a minimum of 18 feet.



## **Monitoring and Documentation**

*(Specification 2528)*

### **Sign Checks and Surveillance**

- Check for cleanliness of the sign surface.
- Check to see that the sign is in good repair.
- Check sign spacing and positioning.



## Chapter 5

---

- Check to see that signs are properly anchored.
- Check signs a minimum of once in AM and once in PM, or whenever a work zone change is made.
- Check signs at night occasionally if traffic control features are to remain in place during nighttime hours.
- Make sign checks and document in the field book daily.
- Document time when correction of noncompliance is made.



### Traffic Quality Control

The Contractor is responsible to review all traffic control operations for compliance with contract documents and maintain a project traffic control daily diary, to be submitted to the Engineer for inclusion in the project records. The diary shall include:

- All reviews of traffic control devices and operations.
- Approved changes to traffic control.
- Incidents affecting the efficiency and safety of traffic.
- List of trained flaggers used on the project.



The Contractor shall have a technician on staff that has attended and passed the exam in an ATSSA Traffic Control Technician or International Municipal signal Association (IMSA) Work Zone Traffic Control training class, even though the Traffic Control portion of the contract may be subcontracted. This Traffic Control Technician shall be responsible for the overall management of the contractor's quality control program for traffic control.



While the quality control specifications shift more of the traffic control monitoring and documentation responsibilities to the contractor, the inspector must still be able to recognize noncomplying conditions or problems developing and respond accordingly.

## **Noncompliance**

*(Specifications 1107.08, 1107.09 & 2528; Construction Manual section 3.21)*

Inspectors must be familiar with traffic control requirements in order to recognize noncomplying conditions. Ground rules for dealing with noncompliance should be discussed with the Contractor at the Preconstruction Conference.

## **Reporting**

- Be alert to recognize potential problems early in the project.
- Discuss traffic control issues with the Contractor before full-blown problems develop.
- Response must be immediate.
- Report noncompliance to the contractor and see to it that corrections are made promptly.
- Cases of noncompliance involving Subcontractor should be reported to the Prime Contractor in addition to the Subcontractor.

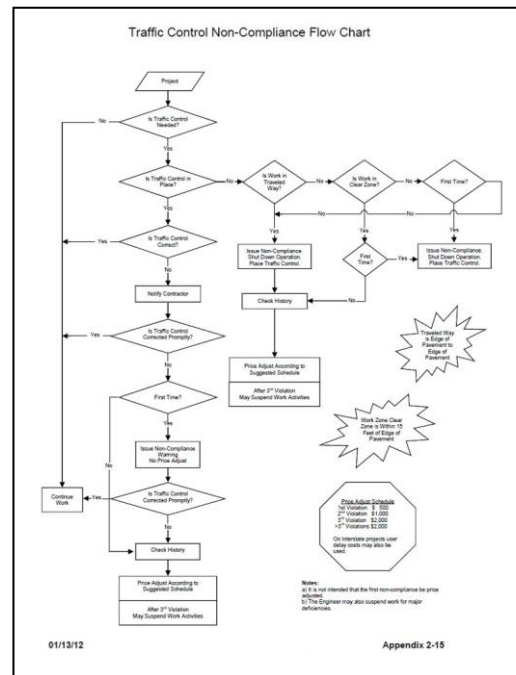

## **Repeated Violations**

- All incidents of noncompliance should be reported to the Engineer.
- In the case of repeated violations and/or major deficiencies, the supervising inspector will issue a Noncompliance Notice (Form 830245) to the contractor.

### **Penalties and Price Adjustments**

- Maintain good records of all incidents of noncompliance; specifics are important for determining penalty.
- If a penalty is to be assessed, a Noncompliance Notice must have been issued at the time of the infraction.
- It does not necessarily follow that penalty will be assessed for every Noncompliance Notice issued.

The flowchart in *Construction Manual Appendix 2-15* provides guidance on applying traffic control noncompliances and price adjustment assessments for various traffic control situations.

### **Accidents**

*(Construction Manual section 5.23)*

Accidents occurring on construction projects must be investigated and reported promptly.

Procedures for handling accidents during non-working hours will be set up in advance by the Resident Construction Engineer. Review *Construction Manual Section 5.23*, Report of Investigation - Vehicle Accident (*Appendix 5-1*), and Work Zone Incident Report (*Appendix 5-2*) for accident reporting forms and procedures.



### **Procedure for handling an accident during working hours:**

- Assist at the accident scene.
- Notify your office.
- Gather the following accident information:
  - Vehicle information
  - Pictures, diagrams, etc.
  - Weather conditions
  - Witnesses
  - Sign locations
  - Copies of the Investigating Law Officer's report
  - Other pertinent information

# **PREPARATION OF GRADE & BASE**



## VI. Preparation of Grade and Base

### **Cleaning & Preparation of Base**

*(Specification 2212)*

This item consists of cleaning and preparation of the base pavement prior to resurfacing with HMA. The contractor is typically required to do the following:

- Remove loose, spalled, and scaled material.
- Remove old patch and joint material, debris, and all other loose material that can be removed with hand tools.
- Clean cracks and joints by brooming and/or blowing out with forced air.

At the time of HMA placement, the entire base shall be free of any foreign material removed by scraping, air hose blast, or brooming. All materials removed from the pavement become the property of the contractor and should be taken off the project.

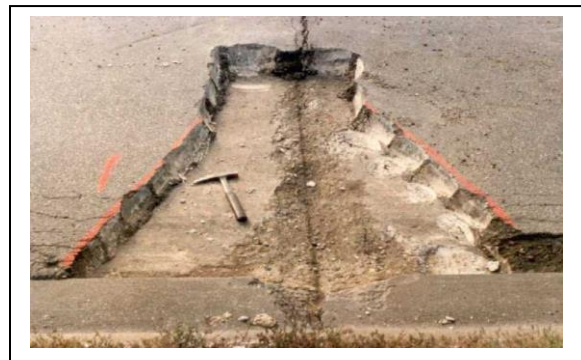

### **Base Repair**

*(Specification 2212)*

In many cases, repairs to the existing base pavement are necessary prior to HMA resurfacing. Base Repair generally consists of surface patches, partial depth repair patches, and full depth repair patches.

#### **Surface Patches**

Surface patches occur where spalled concrete or patching material is removed for a depth greater than one

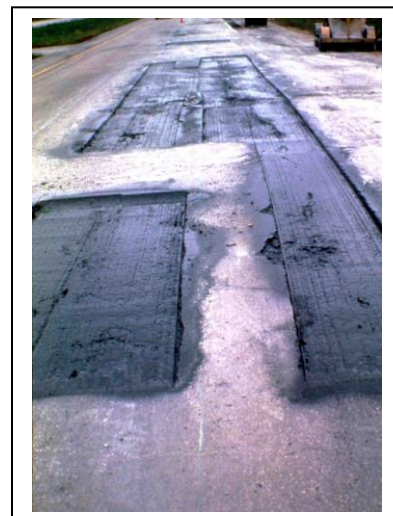

## Chapter 6

inch but less than the total thickness of the old pavement. The areas are cleaned, tack coated and filled with hot mix in lifts not to exceed three inches. A weighted pneumatic tire or mechanical tamper may be used to compact the mix. The final compacted surface shall be level with to  $\frac{1}{4}$ " above the surrounding surface.

### Partial Depth Patches

Partial depth patches are designated areas where the existing pavement is removed to a specified depth, usually by milling, and replaced by specified patching material to provide a new pavement surface.

### Full Depth Patches

Full depth patches are designated areas where the entire pavement section is removed, subbase or subgrade is restored if necessary, and specified patching material placed to provide a new pavement surface.

Patching locations are tabulated in the plans, along with such information as: type of patch, patch dimensions, quantities, and jointing requirements. Thickness, materials, and other specification requirements are based on the type of patch designated in the plans.



### Base Widening (Specification 2213)

Base Widening is necessary when the existing pavement width is less than the design width of the proposed resurfacing. The work involved may consist of excavating the shoulder material, removing existing curb or

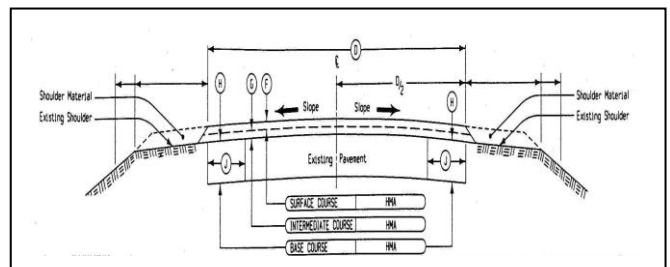

## Chapter 6

---

flumes, and constructing widened portions of base. The contract documents may designate PCC base widening, HMA base widening, or a contractor's option of these types. The plans will show the required total thickness of base widening to be placed. When the contractor's option is designated, payment will be based on square yards.

### **Application of Tack Coat**

*(Specification 2303.03, C, 2)*

The purpose of tack coat is to ensure a bond between the existing pavement surface and the new hot mix asphalt overlay. A good bond can increase the overall structural strength of the pavement and prevent intrusion of water between the layers. If a good bond is not formed between the existing surface and the new overlay, a slippage or sliding-type failure can occur. The pavement surface must be completely clean and free of moisture before the tack coat is applied. The tack coat material, which is normally asphalt emulsion, should be heated to the proper temperature so that it may be sprayed from the nozzles and not come out in strings. Tack coats shall not be applied when the temperature on the surface being covered is less than 25 degrees F.

The amount of tack coat applied to the surface to be overlaid is very important. Too little tack coat can result in no bond between pavement layers. Too much tack coat promotes slippage or sliding between layers and bleeding of asphalt emulsion to the pavement surface. A pavement that is scarified (milled) requires more tack coat than other



## Chapter 6

---

surfaces since this process creates more surface area to cover. Rates of application and other requirements for tack coats are given in the contract documents.

Tack coat must cure or “break” before it is covered with hot mix asphalt. As water evaporates from the asphalt emulsion, the tack coat becomes “tacky” and changes from a brown color to black. The rate of water evaporation will vary depending on the type and grade of emulsion used, the application rate, the temperature of the existing pavement surface, and other environmental conditions.

### **Treatment of Fixtures**

*(Specification 2303.03, C, 7)*

All manholes, intakes, valve boxes, or other fixtures encountered within the area to be covered by HMA shall be adjusted to conform to the final adjacent finished surface. All such fixtures should be identified on Tabulation 104-10 in the plans. Make sure the plan locations match field conditions. Tie out, to known reference points, the location of all fixtures that will be covered. This will minimize the search to uncover them later.

Unless indicated otherwise in the plans, the Contractor has the option of adjusting fixtures prior to placing the final surface course, or after placement of surface course using a composite patch or PCC patch. If the second option is used, the elevation of the adjusted fixture and patch shall not be higher than or more than  $\frac{1}{4}$  inch below the surrounding pavement surface.



### **Fabric Reinforcement**

*(Specification 2303.03, C, 2)*

Fabric reinforcement is sometimes specified between an existing pavement and overlay to prevent cracks, joints, or other defects from reflecting through the resurfacing layer. When fabric reinforcement is required, the locations and dimensions will be tabulated in the plans.

The method of application of fabric reinforcement varies with the type of fabric specified. Some fabrics have an adhesive backing, some use an adhesive binder specified by the manufacturer, and some are applied with a heavy coat of asphalt binder. Specific requirements are included in the contract documents.

Do not place fabric on wet or damp surfaces, or when the road surface is less than 50 degrees F. Precautions must be taken to avoid wrinkles in the fabric and to ensure that air bubbles are removed without breaking the fabric. A broom and/or squeegee is typically used to work out these imperfections. Wrinkles or folds that can't be removed by brushing are to be cut and lapped to provide a smooth surface. Normal traffic should not be allowed on the fabric during application and curing of binder material.

Fabric reinforcement may be placed up to two calendar days prior to being covered by an HMA overlay. Fabric that is soiled or damaged during this period must be repaired. Also, sanding may be required if the area is opened to traffic prior to overlay.



### **Scarification**

*(Specification 2214)*

Scarification is the removal of pavement surface by milling with cold planing equipment in preparation for resurfacing. This is generally done to improve the surface profile and cross section of the underlying pavement. The texture produced has the added benefit of enhancing the bond between the existing surface and the new overlay. The location and depth of the scarification is tabulated on the plans. Debris from scarification shall be removed from the pavement surface immediately and handled as specified in the contract documents. The HMA overlay operation shall start within 10 working days after completion of the scarification operation. Once started, HMA placement shall occur on each working day until the scarified surface is completely covered with HMA. The contractor is subject to penalty for failing to comply with these requirements and is responsible for repairing damage to a scarified surface that occurs during the time period for which penalties are assessed.

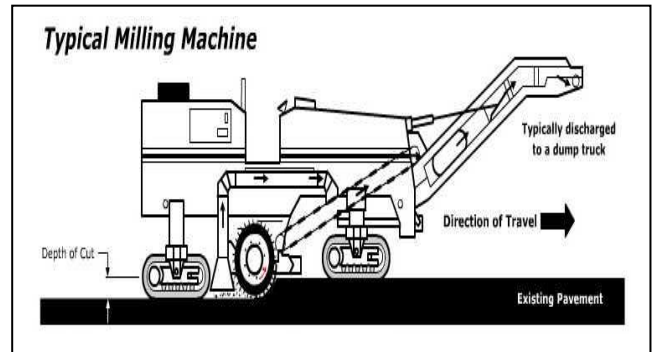

### **Heater Scarification**

*(Specification 2309)*

This work consists of recycling the existing asphalt pavement surface and resurfacing with HMA. This multi-step rehabilitation process involves preparing the existing asphalt pavement surface, softening the surface with heat, scarifying the surface, and thoroughly stirring or tumbling and leveling the mixture in preparation for an HMA surface course overlay.



## Chapter 6

---

The process is typically used in situations where the existing pavement has surface irregularities, such as minor rutting, oxidation or raveling, but remains structurally sound.

### Surface Preparation

The existing pavement surface must be cleaned of all debris, earth, etc. that would interfere with the work to be performed.

### Heating and Scarifying

The pavement surface is evenly heated and scarified for the full lane width as a continuously moving operation. The equipment must be capable of producing at least 10 million BTU's per hour and process a minimum of 1500 square yards per hour without charring or otherwise damaging the existing pavement material. The surface temperature of the old pavement can not exceed 475 degrees F during heating, and the heated material shall be in the range of 220 – 260 degrees F, measured immediately behind the heater scarifier. The heating operation shall be controlled, by enclosure or shielded hood, to prevent open flame from exiting from under the heater. The operation should be stopped if wind velocity creates either a hazardous situation (flame and smoke) or results in an ineffective heating and scarification operation.

Scarification shall be accomplished with pressure-loaded rakes or scarifiers. The minimum depth of scarification is  $\frac{3}{4}$  inch at the highest points, such as between wheel paths, and  $\frac{1}{2}$  inch at the lowest points, such as in the wheel paths.



## Chapter 6

---

### Leveling

Following scarification, the surface is leveled to provide a uniform cross slope. The method used to redistribute and level the scarified material must follow the scarifier as closely as practical and be capable of windrowing excess material to one side for removal when necessary.

### HMA Surface Course Overlay

After reshaping the scarified mix and before the temperature drops below 170 degrees F, a uniform layer of new surface course material is placed at the rate shown in the contract documents. The overlay may either be placed with a non self-propelled paver attached to the heater scarifier, or a conventional self-propelled paver within 400 feet of the scarification operation.



*Please note that alternative Heater Scarification processes exist and may be added to specific projects via Special Provisions or other contract documents.*

### Cold In-place Recycling

*(Specification 2318; Materials IM's 204 & 504)*

Cold In-place Recycling (CIR) is a method of reconstructing an HMA pavement that has typically suffered some type of surface or minor structural failure. These failures may include thermal (transverse) cracking, wheel rutting, stripping, or a combination of these distresses.

The work consists of milling the existing pavement to the width and depth specified, resizing and mixing the milled material with an asphaltic rejuvenating (stabilizing) agent, and placing and





## Chapter 6

compacting the mixture to an accurate grade and profile. The resulting mat provides a flexible base to be utilized as a paving platform for subsequent overlay or surface treatments.

### Preparation

All vegetation and debris within the width of the pavement to be recycled must be cleared.

### Milling Existing Pavement

The existing pavement is milled to required depth and width in one pass. The pulverized material must then be processed to the required gradation.

### Mixing Recycled Material

The Contractor shall apply the asphalt rejuvenating (stabilizing) agent to the pulverized material at the design rate specified. The Engineer may vary the rate as required by existing pavement conditions. Water may be added to facilitate uniform mixing, either prior to or concurrently with adding the rejuvenating (stabilizing) agent.

The contract documents will include applicable design rates and additional specification requirements if “foamed asphalt” is to be used in lieu of asphalt emulsion as the rejuvenating (stabilizing) agent in the recycling process. This is the method of choice for Iowa DOT cold in-place recycling projects. Foamed asphalt is made by adding a small amount of water to hot liquid asphalt binder, causing the water to boil, which in turn causes the binder to foam (much like a pot boiling over). The increased volume of the foam allows more pulverized material to be coated with less water added.

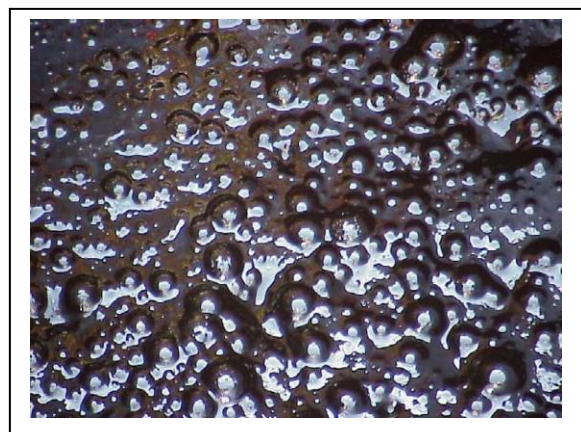
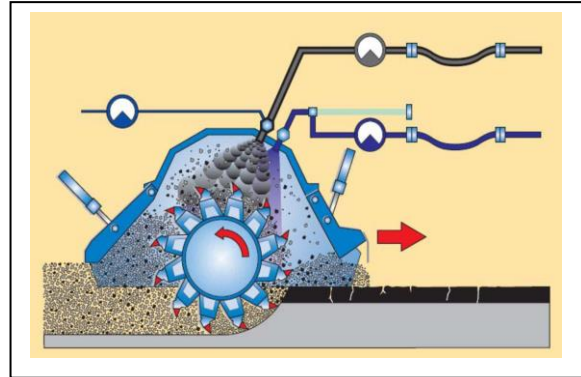

## Chapter 6

---

This can result in faster cure times and a wider working temperature range versus using emulsions.

When foamed asphalt is used as the CIR stabilizing agent, the project inspector should periodically verify that the expansion (foaming action) of the stabilizing agent is adequate to properly coat the RAP particles. This check is commonly referred to as the “bucket test.” The bucket test compares the maximum expansion level of the foamed asphalt with the level after completely collapsing. The resulting “expansion ratio” would ideally be approximately 8:1. Additional details are contained in Materials *IM 504*.



### **Placement of Recycled Material**

The recycled material is deposited in a windrow, spreader, paver, or loaded into trucks, without segregation. The material is placed and finished in one continuous pass, using a paver or approved spreader, to lines and grades established by the Engineer.

### **Compaction and Density**

A pneumatic tired roller (25-ton or greater) is used for initial rolling. Some contractors feel a 30-ton model is necessary to achieve required density. Final rolling with a steel tired roller, operating in either vibratory or static mode, follows to eliminate roller tire marks. Additional rolling may be required, within two calendar days of initial compaction, to achieve target density. Minimum field density shall be 94% for Interstate and Primary roads, and 92% for all other roads. The Contractor must perform ten daily nuclear gauge moisture and density tests at locations determined by the Engineer, as per Materials *IM 204*.



## Chapter 6

---

CIR is typically performed between May 1 and October 1, followed by an overlay or surface treatment. Any subsequent treatment or HMA overlay placement cannot occur until the in-place recycled pavement meets applicable moisture content and/or drying period criteria listed in Specification 2318.

### **Slab Fracturing Processes**

*(Specifications 2216 & 2217)*

Slab Fracturing processes are used to stabilize an existing PCC pavement prior to HMA resurfacing. The slab fracturing rehabilitation technique involves two stages: the “fracturing” process and the “seating” (compaction) process. There are three main types of slab fracturing processes – Crack and Seat, Break and Seat, and Rubblization.

#### **Crack and Seat**

The objective of the Crack and Seat technique is to minimize/eliminate reflective cracking in the HMA overlay by reducing the effective slab length of the PCC pavement. With a small effective slab length, horizontal slab movement is reduced. The cracking process is intended to produce tight cracks that permit load transfer with minimal loss of structural value. Seating of the broken slabs after cracking is intended to re-establish support between the base or subbase and the fractured slab. The Crack and Seat technique is applicable to jointed plain concrete pavements.

#### **Break and Seat**

The objective of the Break and Seat technique is essentially the same as Crack and Seat. However, the amount of effort required to reduce the slab size

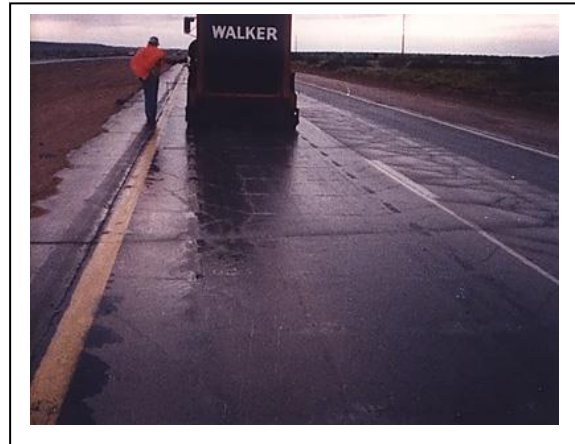

## Chapter 6

---

is normally greater. The increased effort is necessary because the original pavement typically contains steel reinforcing bars or wire mesh reinforcement. In order to reduce horizontal slab movements, all slab reinforcement in the PCC pavement must be broken and/or the concrete to steel bond must be destroyed for this technique to be truly effective in eliminating reflective cracking. The Break and Seat technique is considered applicable to jointed reinforced concrete pavements.



### **Rubblization**

The objective of the Rubblization technique is to eliminate reflective cracking in the HMA overlay by the total destruction of the existing slab action of the PCC pavement. This process is normally achieved by rubblizing the slab into fragments of nominal 4 inch size and less. This is often referred to as “full” rubblization. Existing site conditions may warrant larger maximum particle dimensions, not to exceed 12 inches (also known as “modified” rubblization). This is to ensure adequate structural support for the overlay, in areas with disintegrating PCC and/or high subgrade moisture. Reinforcing steel, if present in the PCC pavement, is generally fully debonded from the concrete by this approach. The Rubblization technique is applicable to all types of existing PCC pavements.

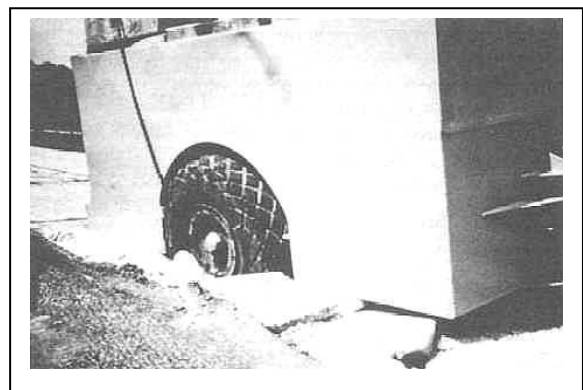

### **Fracturing Equipment & Techniques**

A variety of equipment can be used to accomplish the preparation of the fractured slab for eventual placement of the tack coat and HMA overlay.

## Chapter 6

---

Equipment typically used for cracking, breaking, and rubblizing PCC pavements include resonant pavement breaker, guillotine, and hydraulic / pneumatic hammers. The most effective type of equipment for a particular process may vary with existing pavement and other site conditions. A water system may be necessary to suppress dust caused by these operations, especially rubblization, and to verify slab-cracking effectiveness by better revealing the crack pattern.



### Seating Equipment & Techniques

The purpose of seating during the construction process for Crack & Seat and Break & Seat projects is to ensure complete contact of the fractured slab with the subgrade, and to provide a compacted fractured slab upon which the HMA overlay may be placed. For both Crack & Seat and Break & Seat projects, this is usually accomplished with a 50-ton rubber tired roller. In addition to seating the slab fragments, the heavy rubber tired roller also effectively serves as a “proof roller” for locating soft spots or existing voids under the fractured PCC pavement. For Rubblization, several passes with a 10-ton vibratory roller are typically employed to compact and prepare the rubblized slab fragments for placement of the HMA overlay.



### Slab Fracturing Process

#### Considerations:

1. Existing HMA overlays must be totally removed prior to the slab fracture process.
2. Use a test section to establish the desirable impact energy and impact spacing for the particular pavement system / fracture equipment combination to be used.



## Chapter 6

---

3. The resulting crack pattern is dependent on the type of equipment used.
  - Hydraulic / pneumatic hammers produce map-cracking pattern.
  - Guillotine produces a series of parallel transverse cracks.
  - Sonic (resonant) breakers result in a large size graded granular base/subbase quality.
4. Crack spacing is dependent upon the type of fracture equipment used and the type of existing PCC pavement to be fractured. As a general rule, the smaller the crack spacing and/or fragment size achieved, the greater the likelihood that reflective cracking will be eliminated in the HMA overlay.
5. Any soft spots and/or void areas located by the heavy proof rollers used in the seating process should be removed, replaced with comparable material, and then recompact.
6. In general, traffic should not be allowed on seated (compacted) fractured slab layers. At least one lift of HMA overlay should be placed prior to having traffic operate on the rehabilitated lane.
7. Care should be exercised to avoid exposing the fractured slab layer to rains, which tend to saturate and weaken the existing fractured slab pavement system. In general, the HMA overlay should occur within 24 hours of the seating process.



### **Special Backfill**

*(Specification 4132)*

Material used for special backfill shall be a uniform mixture of coarse and fine particles of crushed concrete, crushed limestone, or a mixture of gravel, sand, and soil, or a mixture of crushed limestone, gravel, sand, and soil. The requirement for this material is that it must meet a certain gradation: Gradation No. 30 of the Aggregate Gradation Table for crushed limestone or crushed concrete, and gradation No. 31 when mixed with gravel, sand, and soil. Since the materials vary, different behaviors may be expected.



Previously used as a subbase for full-depth HMA pavements, Special Backfill was intended to provide stability and allow construction traffic to run on the base during the paving operation. This is important in the delivery of hot mix to the paver. However, the drainability (permeability) of the layer often varied with the type of material used.

### **Modified Subbase**

*(Specification 2115)*

A relatively new material gradation has replaced Special Backfill in some applications. Modified Subbase was developed to address unacceptable stability and drainage characteristics of some sources of Special Backfill. Modified Subbase is typically specified under full-depth HMA pavements. Other uses for the material include pavement subbase under ramps and bridge approaches. This material has shown to provide the benefits of being stable enough to support construction traffic,



## Chapter 6

---

while still providing acceptable drainage characteristics with pavement in place.

The existing subgrade must be properly prepared prior to placement of modified subbase. This consists of disking to a depth of six inches, aerating, and recompacting. The subgrade is then proof-rolled with a loaded truck (as discussed in the next section), and any unstable areas corrected.

The following requirements must be adhered to when constructing Modified Subbase:

- Modified Subbase material shall be uniformly moist prior to and during compaction.
- Modified Subbase shall be placed in uniform lifts of not more than six inches.
- Modified Subbase shall be compacted with a minimum of six roller passes.

The specifications provide gradation and other material, equipment, and construction requirements for Modified Subbase.

### **Unstable Subgrades and Subbases**

*(Specification 2109.03; Construction Manual section 8.41)*

Inspectors shall not permit HMA to be placed over any distorted subgrade or subbase. Whenever trucks or other paving equipment cause rutting of subbase or subgrade in the HMA placement area, such that the layer being placed does not conform to design dimensions, inspectors shall immediately stop construction.





## Chapter 6

---

Construction shall not be permitted to resume until distorted subbase or subgrade has been repaired.

Locating wet or soft spots in advance can be accomplished by proof rolling the finished subgrade or subbase with a loaded truck. The amount of indentation of the truck wheels into base material should be noted and compared with recognized limits. When excessive distortions are observed under the truck, the unstable areas must be dried and reworked or stabilized, as necessary.

Areas of deep instability may require additional treatment, including coring out of unstable material and replacing it with a more stable material, adding subdrains, or over-depth paving.

Paving should not proceed unless testing gives a reasonable indication that distortions will not occur during construction of overlying pavement.

**MIX DELIVERY**  
**PLACEMENT & COMPACTION**

## VII. Mix Delivery, Placement, and Compaction

### Truck Unloading

Observe trucks unloading. The mix should look uniform. If segregation (non-uniform distribution of aggregate sizes in mix) is noticed, this is a good indication that there is a problem in the plant or in the way the trucks are being loaded. Also, look for other visual indicators of potential deficiencies in the mix, such as blue smoke (overheated mix), stiff appearance (cool mix), mix slumped in the truck (excess asphalt binder), or a lean, dull appearance (too little asphalt binder). Loads exhibiting such characteristics require close inspection and possible corrective action.

For bottom-dump trucks, the windrow of mix placed ahead of the pickup machine must be properly sized and located to meet the needs of the paver. The windrow size is normally controlled by the width of the gate opening under the truck and the speed of the truck. The amount of mix delivered is dependent on the width and thickness of the layer being placed by the paver. Ideally, the windrow should be sized so that the paver hopper is consistently 25 to 75 percent full during operation. The windrow should be centered in the lane being placed, and never extend more than two truckloads ahead of the paver. The actual distance the windrow is placed ahead of the paver depends on the speed of the paver, along with the mix temperature, weather, and other conditions that affect the rate of mix cooling.

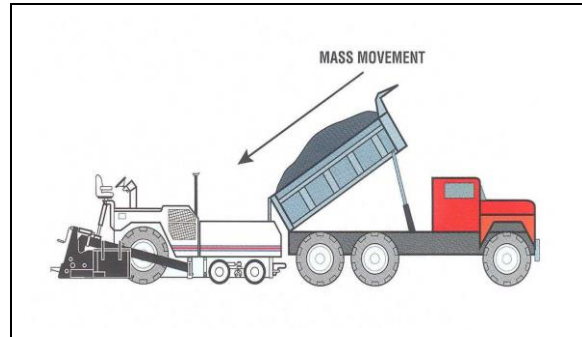

## Chapter 7

---

With end-dump trucks, unloading becomes an art. For continuous paving operations, the paver operator will “pick up” trucks while the paver is moving forward. This technique will reduce the incidence of screed marks and roughness in the mat due to trucks backing into and bumping the paver. The truck is dumped into the paver hopper while the paver is on the move. To minimize segregation, flood the hopper as much as possible. When the hopper is fully loaded, the mix tends to be conveyed from under the load rather than streaming from the truck into the hopper.

Watch for excessive spillage that falls in the path of the paver. Wheels or tracks that run over this will lift up and distort the trailing mat. If this occurs, stop the paver until the spillage is cleaned up. Watch for mix remaining in the corners of the truck bed after the load is dumped. Any remaining material needs to be removed before the truck is loaded again. However, drivers should be discouraged from the practice of “banging the gate” ahead of the paver to expel remaining mix from end-dump trucks. Cool, crusted mix that has been loosened from the truck bed must be completely removed from the project, and not incorporated in the mat.

Any equipment, including trucks, leaking fluid must be removed immediately from the paving train to avoid contaminating the mat. Many types of equipment fluids act as solvents, which can break down the asphalt binder in the mix and lead to premature deterioration of HMA pavement.

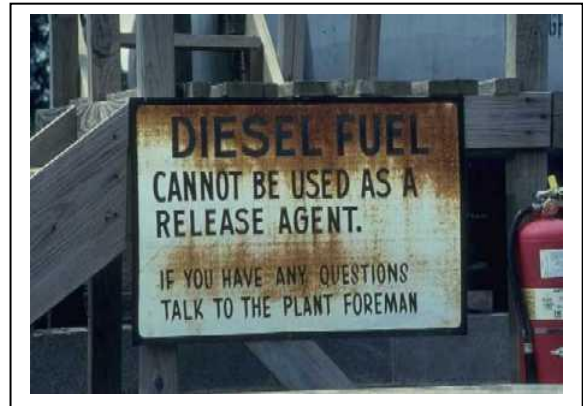

## Chapter 7

Do not allow the use of diesel fuel, kerosene or distillates for cleaning truck boxes or other equipment that comes into contact with the mix. If treated with distillates, trucks must drain for a minimum of 5 hours prior to being used to haul mix. Approved release agents are found in Materials *IM 491.15*.

### Dimensions

(Construction Manual sections 8.52 & 8.53)

Typical Sections are located in the plans that detail the design thickness, width, cross-slope, and other dimensions of the finished pavement. The inspector should review the plans to become familiar with these requirements and make frequent checks to insure they are being obtained.

The plans will show the total thickness of each course (base, intermediate, and surface) required for the project. The contractor must divulge the lift thickness(es) he intends to place in order to obtain the finished plan dimensions. Each placement thickness must be within the allowable range of lift thickness for the mix size specified. In general, lift thickness must be at least three times the nominal maximum aggregate size for effective compaction.

Since a typical HMA pavement will broaden in width during rolling, the contractor must adjust the spreading width so that the final dimension (as constructed) conforms to the design width specified in the contract documents.

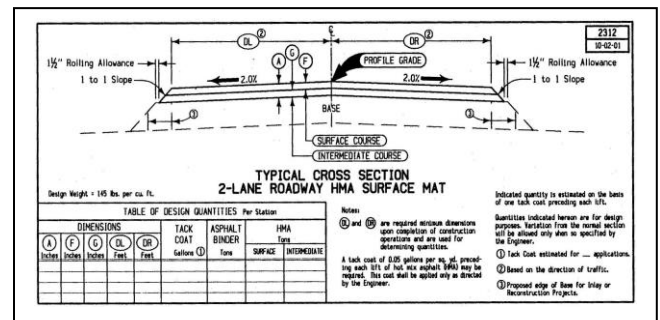
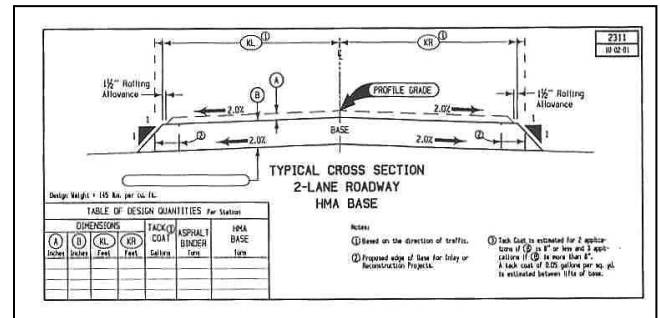
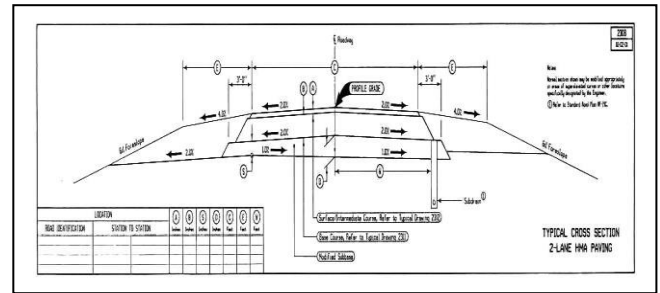

## Chapter 7

---

Spread rates for hot mix asphalt are normally found by using the contract quantity of mix as a basis. If the contract quantity is not sufficient to construct the required thickness, notify your supervisor as soon as possible. If necessary, the Construction Residency can contact the District Office to obtain spread rate adjustments required to obtain the design thickness.

### **String Line**

*(Specification 2303.03, C, 4;  
Construction Manual section 8.43)*

A wire / string guideline is used to guide the finishing machine and to maintain alignment. The inspector should make frequent checks to ensure the guideline string has been correctly set and maintained. Nails used to secure guideline string must be located at intervals close enough to provide a smooth transition and eliminate “chords” through curves.

The finishing machine operator shall follow the guideline string exactly. If machine goes offline for any reason, it shall be adjusted back onto the line immediately. It is incorrect to smooth out the edge alignment by coming back onto the line gradually. This produces long stretches where incorrect lap at the centerline joint will occur. A lack of material at the joint results in insufficient mix compaction, leading to water infiltration and premature deterioration of the pavement.



## Edge Alignment

(Construction Manual section 8.43)

The use of a string/guideline is very important for good edge alignment. Establish the center of the pavement early in the project and work from this line throughout the project. Check the contractor's methods and measurements to verify that the contractor is maintaining the line and making the appropriate adjustments.

When placing string/guideline through curve sections, make sure that the contractor is locating it with enough intermediate points to form a smooth radius, avoiding the appearance of placing a series of longer chords around the curve.

If a jog in the alignment occurs, have the contractor stop and correct both the centerline and edge line immediately. If cracking is noticed on the outside edge of the mat, check to see if the edge of the overlaying mat is being placed incorrectly by overhanging the underlying roadway surface.

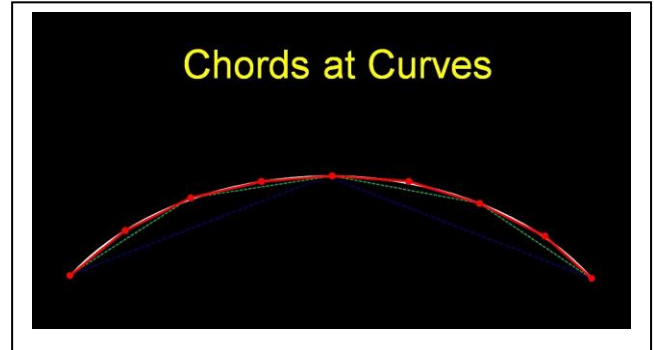

## Wedge, Leveling, and Strengthening Courses

(Specification 2303.03, C, 7;  
Construction Manual section 8.51;  
Standard Road Plan PV-202;  
Detail Sheet 560-4)

### Wedge Courses

Wedge courses are placed on resurfacing projects to correct (usually increase) the superelevation of existing roadway curves. Project plans will identify required rate of superelevation and transition lengths.

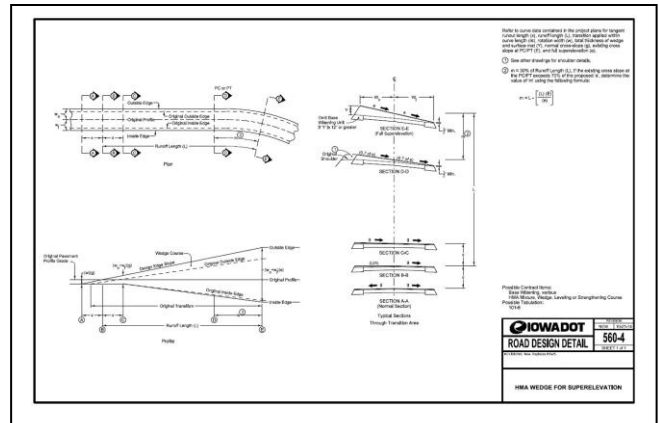

## Chapter 7

*Detail Sheet 560-4* provides additional detailed geometric design information used for superelevation wedge layout at various speeds and degrees of curvature.

In placing a wedge course, the maximum thickness of individual layers, when compacted, shall not exceed three inches. When rolling, care shall be used to avoid crushing the coarse aggregate in the thinner portion of the wedge. Wedge courses shall be placed to the full width of pavement before any other course is placed thereon.

*Construction Manual section 8.51* provides procedures to use in determining layout and placement of successive passes of wedge courses and placement sequence of required lifts. The inspector should constantly check the slope using 4-foot level and ruler. If the desired slope is not obtained on a given pass, then adjust slope and thickness of the next pass. The final pass should always be at the final superelevation rate.

### Leveling Courses

Leveling courses are used to correct existing pavement surface distortions, such as depressions or low areas typically more than one inch deep. The contract documents will show the thickness of the courses to be placed. A scratch course is a type of leveling course sometimes used to make minor corrections to the existing surface. The term “scratch” relates to the screed scratching on the aggregate, as the lift thickness is set at or just above the largest aggregate size in the mix. For scratch courses, the lift thickness does not adhere to the normal 3:1 (lift thickness: nominal maximum aggregate size) requirement.

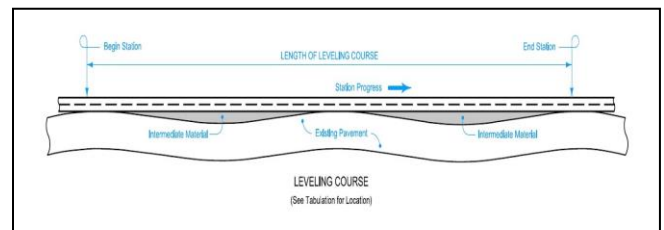
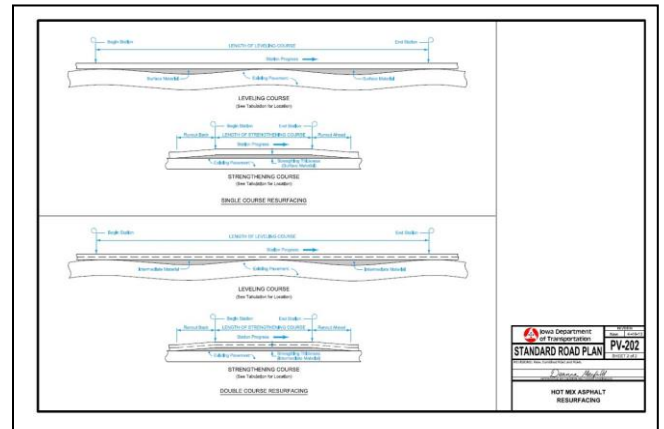



## Chapter 7

Leveling courses are compacted using pneumatic rollers to ensure uniform compaction versus “bridging” of mix over existing depressions.

### Strengthening Courses

Strengthening courses are placed over weak areas in the existing pavement. The contract documents will show the thickness of the courses to be placed.

*Standard Road Plan PV-202* shows typical details for leveling and strengthening courses in conjunction with double course and single course resurfacing, respectively. When the depth of leveling & strengthening course is more than three inches, the desired depth shall be placed in approximately equal layers not exceeding three inches thickness.

Areas of wedge, leveling and strengthening courses will be identified on the plans. Always check to make sure the plan locations match the actual field conditions.

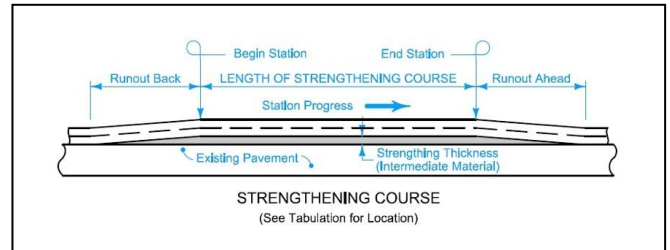

### Paver Speeds and Plant Production

(*Specification 2303.03, C, 3;*  
*Construction Manual section 8.13*)

Uniformity and consistency of operations is essential in hot mix asphalt paving. Uniform, continuous operation of the paver produces the highest quality pavement.

It is important to adjust paver speed to match plant output in order to minimize paver stoppages. Frequent stops of the paver may allow the screed to settle, creating bumps in the roadway surface.



## Chapter 7

Trying to continue laying mat with long waits between truckloads will decrease the head of mix in front of the screed, allowing it to settle and create a dip. Ideally, paver speed should be adjusted to delivery rate so that the paver does not have to stop and is not starved for mix as it is moving forward between loads.

Work with the contractor to make the appropriate adjustments so that the paver and plant are similar in their output. Adjustments to achieve proper paver speed must take the following into account: plant production, haul distance, number of haul trucks available, and lag time between loads due to traffic control or other delays.

### **Paver Operations**

*(Specifications 2001.19 & 2303.03, C, 3 & 4)*

While the proper operation and adjustment of the paver is the responsibility of the contractor, there are a number of things the inspector can check to ensure that a high quality pavement is produced:

- Keep the paver hopper sufficiently full at all times. The hopper level should consistently run between 25 and 75 percent full.
- If load interval segregation is present, make sure the contractor is not lifting the wings with each load.
- Make sure that the augers are running as much of the time as possible. To control this, the speed of the conveyor and the control gates can be adjusted to maximize the use of the augers.

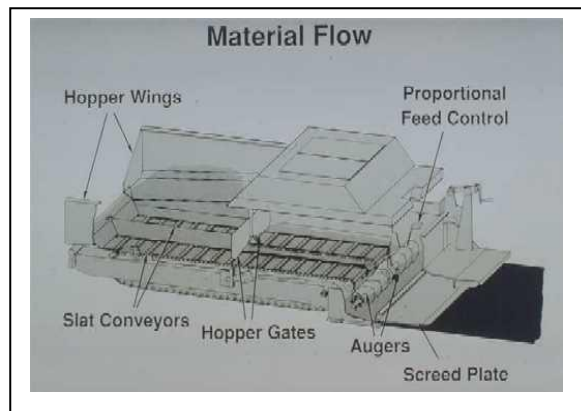

## Chapter 7

- Try to keep a consistent level of HMA ahead of the screed.
- Screed vibrators shall be in operation at all times mix is being laid. They should be run per manufacturer's recommendations.
- Check the automatic grade and slope controls. When approaching a curve, the automatic slope control can be shut off and controlled manually.
- The paver shall have automatic screed controls, except for the following instances:
  - Wedge courses.
  - Curb-fill resurfacing.
  - Urban type sections where fixtures or the other permanent grade control features take precedence.
  - Surfacing layers 1-inch or less in thickness.
  - Scratch courses.

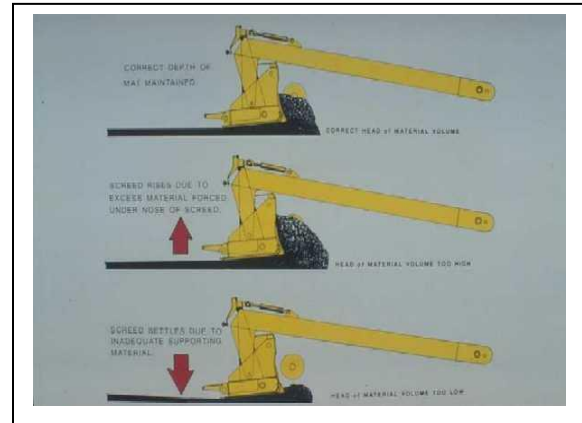

## Runouts

(Standard Road Plans PR-201, PR-202, and PV-202)

Runouts, sometimes called wedge shaped fillets, are used to provide a vertical transition from resurfacing course(s) to an existing pavement surface. The length of the runout is based on the thickness of the HMA resurfacing. Runout locations and lengths are found on Tabulation 100-25 and/or Tabulation 102-16 in the plans. Other runout information is found on the Standard Road Plans referenced above or may be included in plans by special notations or typical sections.

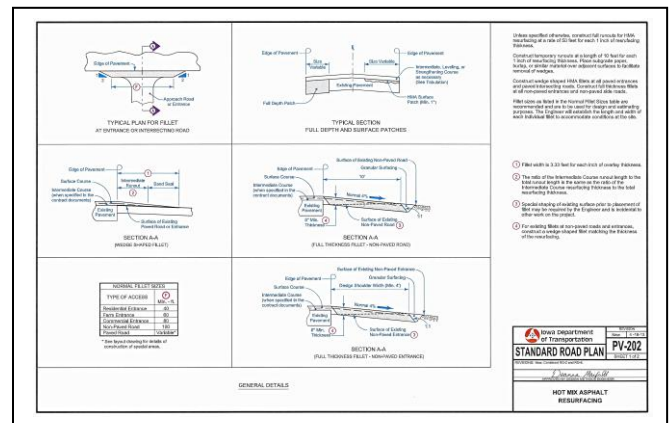

## Chapter 7

---

There are many different runout typical details available to fit many different situations (single vs. multiple lifts, notched vs. full runouts, etc.).

Use the information provided in the plans to layout and mark the runout location in the field. Make sure runouts fit field conditions properly, in order to prevent bumps.

The surface of the permanent runout is typically sand sealed after placement, to prevent water infiltration and premature deterioration of the thin HMA wedge.



### **Transverse Joints & Runouts**

*(Specifications 2001.19 & 2303.03, C, 6;  
Standard Road Plans PR-201 & PR-202)*

#### **Temporary Runouts**

- Slow paver and runout remaining material in the hopper.
- In order to maintain the proper mat thickness, the screed should be raised when the level of mix reaches the center of the auger shaft.
- Move paver; remove excess material to form a straight vertical edge along the joint.
- Place joint paper or burlap to separate the permanent pavement from the temporary runout material.
- Construct a temporary runout, tapering to the existing surface at the rate of no less than 10 feet of length for each 1 inch of compacted mat thickness being laid.



## Chapter 7

### Taking off from a Cold Joint

- Remove the joint paper (or burlap) and temporary runout material. The header shall be sawed to a straight line at right angles to the centerline, so that a full thickness vertical edge is provided.
- Make sure the screed is hot, but do not allow the screed to be placed directly on the existing mat.
- The contractor should use blocking material placed on the cold mat side of the joint in order to shim up the screed to obtain the desired lift thickness. The thickness of the shims is typically 20-25% of the compacted lift thickness (based on expected roll-down of the mix).
- After paving approximately 30 to 50 feet, check the surface with a 10-foot straight edge or string line.
- Continue paving if acceptable.
- If substantial bumps or dips are evident, scoop out the wheel tracks, back the paver up to the joint, and repave.

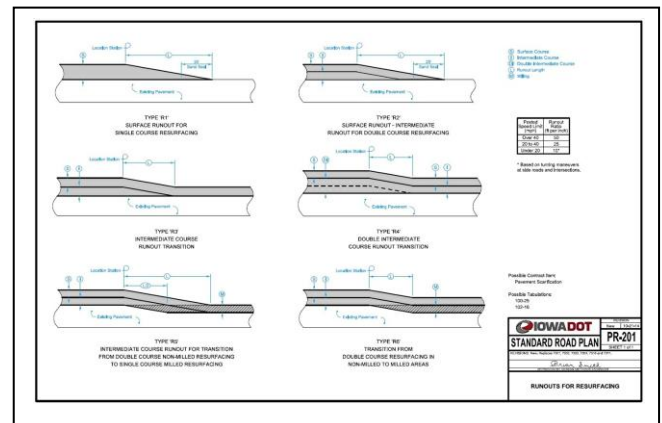
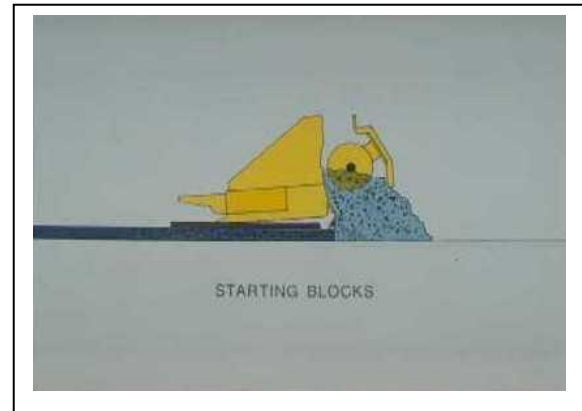

### Permanent Runout

- Taper at a rate of 50 feet to 1 inch of mat thickness being laid, or as specified on the plans.
- String line the existing slab in the area of the runout ahead of laying mix to see how the runout will tie into the existing profile. The length of the runout may have to be adjusted in order to achieve a smooth transition.
- Use a sand seal on the surface course runout as per plan and specification.

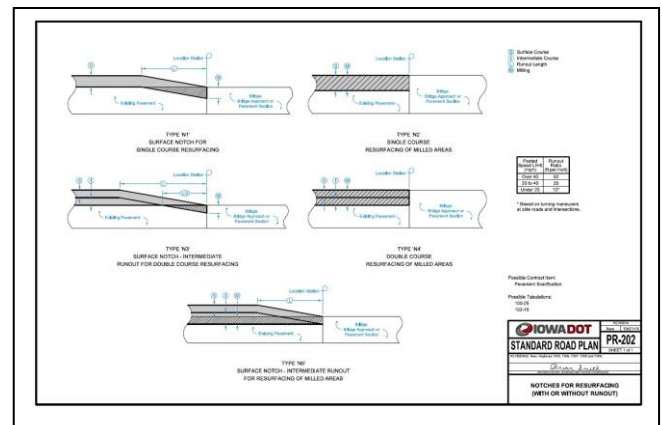

### **Longitudinal Joints**

(Specification 2303.03, C, 6;  
Construction Manual section 8.44)

Longitudinal joints occur wherever adjacent lanes are placed. Hot joints are formed when two pavers are operated in echelon. Cold joints occur when one lane is placed and compacted. At a later time, after the first lane has cooled, the companion lane is placed against it. Cold joints will be emphasized in this section, as they are the predominate type of longitudinal joint used.

There are several procedures that must be followed to ensure a high quality HMA longitudinal joint:

#### **First Lane Placement**

- Use a string line to maintain true edge alignment at longitudinal joint locations. The string line should be secured with extra nails in curves to minimize the “chord” effect, thereby facilitating a better joint match by the second lane.
- Provide enough mix at the end of the screed by maintaining a consistent head of mix along the length of the paver augers. Mix confinement by the end gate will result in a more uniform edge to match.
- The vertical face of the exposed longitudinal joint (cold mat) must be tack coated, as a separate operation, before placing the adjacent lane. This insures a good seal at the joint. Do not allow tack to be over-sprayed on the surface of the lane being matched.



### Second Lane Placement

- Allow 1/2 to 1-1/2 inches of overlap at the joint, with 1-inch being preferred. Too much lap at centerline will result in a wide scab of mixture at the surface or the appearance of a white streak at the joint, caused by the roller crushing aggregate in the mix against the surface of the cold mat.
- Allow enough loose lift thickness to compensate for roll down so that no bump or dip is produced at the joint (20 to 25 percent reduction in thickness is typical). If the loose lift thickness is insufficient prior to rolling, the joint will appear smooth but lack density.
- Keep the end plate of the paver tight against the screed and tight against the surface of the cold mat. Do not allow mix to run out between the edge of screed and end plate, or in front of the end plate.
- Minimize the amount of handwork used in constructing longitudinal joints. This includes raking, luting, and “bumping” the joint. If excess mix is placed at the joint location, the extra material should be pulled back and removed, rather than “broadcast” across the mat’s surface. Once adjusted, the paver will do a better job of uniformly placing the mix than can be achieved by using hand tools.
- Compact the joint from the hot side of the joint, not the cold side. This allows thru traffic to use the adjacent lane, and also prevents damage to the cold mat by vibratory (breakdown) rollers. Never have the vibrators turned on when the



## Chapter 7

---

majority of the breakdown roller is being supported by the cold side of the joint.

### **Hand Spreading**

*(Specification 2303.03, C, 4)*

Whenever practical, mix should be spread by the paver with no handwork necessary. "Bumping" of mix at centerline joint should not be necessary if the paver is being properly operated. Stop the lay down operation if there is excessive handwork required and correct the cause of the problem.

In small or irregular areas, however, spreading by hand may be unavoidable, as paver use is often either impossible or impractical. Placing and spreading by hand should be done carefully and the material distributed evenly to avoid segregating the mix. Workers shall not stand on the loose mixture while spreading.

All rakes, shovels, and other tools used for hand spreading shall be of a type designed for use on hot mix asphalt mixtures.

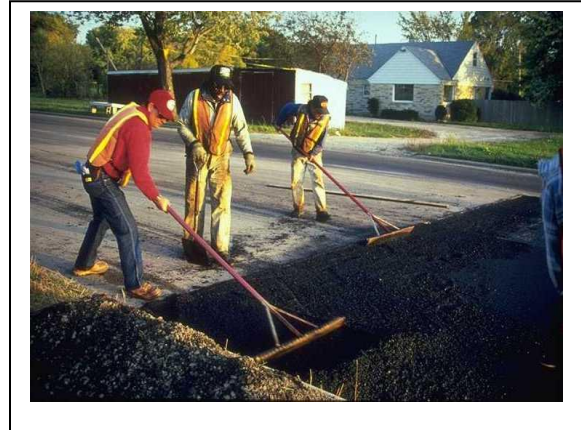

### **Compaction**

*(Specification 2303.03, C, 5)*

Compaction is the process through which the HMA mix is compressed and reduced in volume. Compaction permits the unit weight, or density, of the mix to be increased by placing more materials in a given volume of space. As a result of the compaction process, the asphalt binder-coated aggregates in the mix are forced closer together, which increases





## Chapter 7

aggregate interlock and inter-particle friction, and also reduces the air void content in the mix to a desirable level.

Compaction is the single most important factor that affects the ultimate performance of a hot mix asphalt pavement. Adequate compaction of the mix increases the fatigue life, decreases permanent deformation (rutting), reduces oxidation or aging, decreases moisture damage, and increases strength and stability. An HMA mixture that has all the desirable mix design characteristics will perform poorly under traffic if that mix is not compacted to the proper density level.

The mechanics of compaction involve three main forces at work: the compressive force of the rollers, the resistive forces within the mixture, and the supporting forces exerted by the surface beneath the mat, be it subgrade, aggregate base, or pavement. If the underlying surface is not firm and stable, the hot mix asphalt will not be confined, and compaction will not be achieved. Similarly, if the hot mix asphalt is not stable enough to resist the compaction forces, it will tend to displace and not compact to the desired air void level. Finally, if the rollers do not exert enough force to overcome resistance within the mixture, the pavement will not be sufficiently compacted.

Internal resistance of the hot mix asphalt greatly affects compaction, and is dependent upon:

- Mixture properties and characteristics
- Environmental conditions
- Layer (lift) thickness
- Subgrade and bases

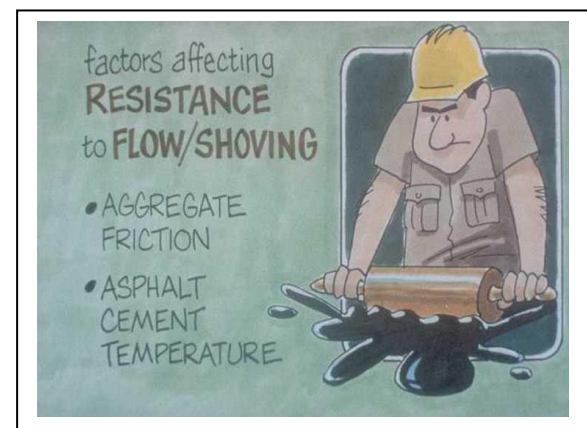
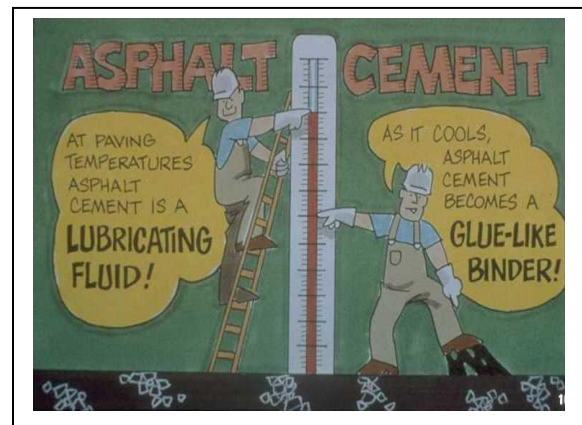

## Chapter 7

### Mix Properties and Characteristics

It is important to remember that hot mix asphalt is a combination of aggregate and asphalt binder.

Interlocking aggregate acts as the structural skeleton of the pavement, and asphalt binder acts as the glue which holds the mixture together.

Aggregate gradation, surface texture and angularity are the primary characteristics that affect workability of a mixture. Mixtures with large amounts of coarse aggregate, along with higher levels of surface texture and angularity, require a greater amount of effort to compact.

Asphalt binder is a thermoplastic, temperature susceptible material. At higher temperatures, it acts as a lubricant, coating aggregate particles and facilitating compaction of the mixture. As the asphalt binder cools, it becomes stiffer and binds the aggregates to produce a long lasting mixture. All compaction must take place before the in-place mix temperature falls below the prescribed minimum for the type of asphalt binder in the mix.

### Environmental Conditions

Construction of quality pavements is highly dependent on the conditions under which they are placed. Ambient air temperature, wind, and the temperature of the surface on which the hot mix asphalt is placed can all affect the cooling rate of the mixture.

Placement and compaction of hot mix asphalt is often a race against time. Cool air temperatures, strong winds, and cool surfaces can shorten the time in which compaction must take place.

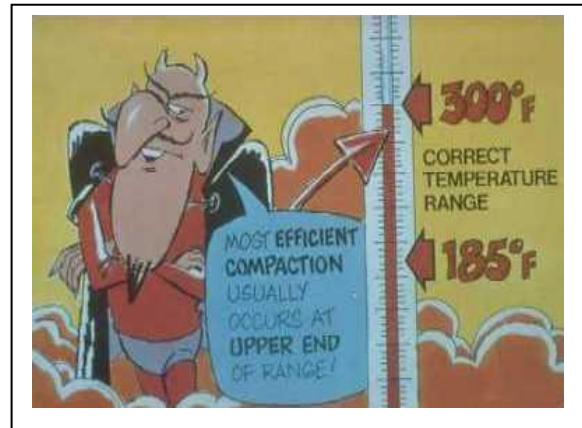

MAJOR FACTORS AFFECTING ROLLING TIME	allows MORE time	allows LESS time
MAT THICKNESS	THICK	THIN
MIX TEMPERATURE	HIGH	LOW
BASE TEMPERATURE	HIGH	LOW



## Chapter 7

---

Increasing plant mix temperature, covering hauling units, minimizing haul length, and shortening windrows in front of pickup machines can all minimize the effects of the environment on HMA paving.

### Layer Thickness

All HMA mixtures cool with time. The greater the surface area of the mixture, the faster the environment can cool the mixture. Thick layers, or lifts, have less material exposed to the air and subsurface in relation to their volume, and therefore cool slower.

Generally, it is easier to achieve required density in thicker lifts than in thinner ones. This is because the thicker the mat, the longer it retains heat, thus increasing the time during which compaction can take place. Thicker layers can permit mixtures to be placed at lower temperatures because of the reduced rate of cooling.

### Subgrade and Bases

The subgrade or base must be firm and non-yielding under the haul trucks and other construction equipment. Subgrades or bases that show movement under equipment will require additional compaction or some type of remedial action to overcome the softness. Such remedial work may include PCC or lime stabilization, or removal and replacement with more suitable material. In some cases, the size and weight of the haul trucks or other construction equipment may be limited to prevent damage to the base.



### **Roller Operations**

#### **Breakdown**

Breakdown rolling is the first interaction between the roller and the mat. Most contractors use steel drum vibratory rollers to breakdown the mix, increase the mat density, and establish the mat smoothness. However, some may use rubber-tired rollers for this operation.

The majority of density is obtained during breakdown rolling, so it is important to keep this roller moving as much of the time as possible. Rollers should always stop and start slowly on the uncompacted mix and angle the drum when stopping to reverse. When the roller does stop, it is important to park on a cold mat. Parking on a hot mat, particularly near the paver, will leave roller marks that are difficult to remove.

In most cases, the breakdown roller(s) should follow the paver as closely as possible. It is important to obtain as much compaction as possible before the mat has cooled significantly. This is especially true when working in cool and/or windy conditions, or when compacting tender mixes. *Tender mixes are discussed in more detail in Chapter 9 of this manual.*

#### **Intermediate**

Intermediate rolling may or may not be required on a project. In most cases, a pneumatic (rubber-tired) roller is used. Intermediate rolling is usually required if adequate density cannot be achieved with the breakdown roller, or if the surface texture and kneading action of a rubber-tired roller is desired.

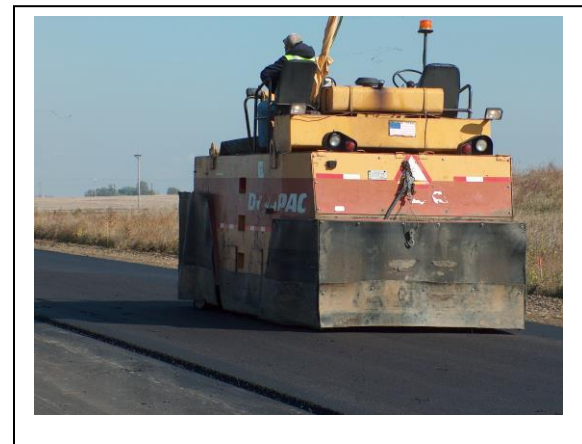

## Chapter 7

Intermediate rolling is commonly seen on interstate and higher volume primary paving projects, which typically use stiffer mixes and higher crushed aggregate contents.

Intermediate rollers generally operate at higher speeds than breakdown rollers, and often make more passes over a given section of mat than other roller types. As with breakdown rollers, intermediate rollers may operate independently or in tandem, depending on paver production rates, mat cooling rates, and other variables.

### Finish

Finish rolling is the last step in the operation and is normally used to “iron” out any roller marks left by breakdown and intermediate rollers. Very little additional compaction is achieved during finishing rolling, as it is done after the mat has cooled significantly. This roller is typically a static steel wheel roller, or a steel vibratory roller operating in a static mode.

### Classes of Compaction

(Specification 2303.03, C, 5)

The Iowa DOT specifies two classes of compaction, Class I and Class II. Class I compaction is intended for use on base, intermediate and surface courses for traffic lanes, ramps and loops on Interstate, Primary, and Secondary highways. Class II compaction is intended for paved shoulders, temporary crossovers, onsite detours, base widening in a non-travel lane and for other situations where Class I compaction is not specified.

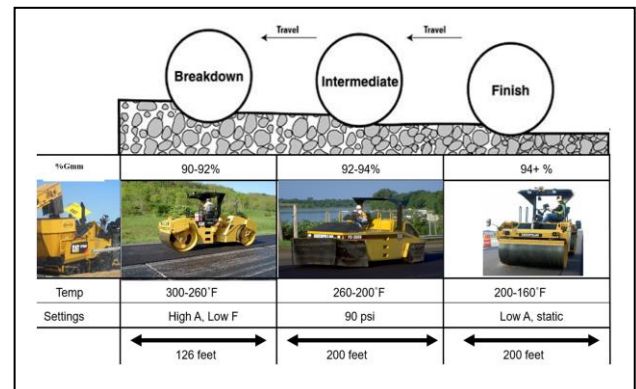

## Chapter 7

---

### **Class I Compaction**

Class I compaction specifications require a minimum of 91.5 percent of maximum specific gravity (G<sub>mm</sub>) for all mainline paving. Payment is determined by Quality Index (Q.I.) and Percent Within Limits (PWL) calculations for the lot, based on 8.5 percent maximum and 3.5 percent minimum field voids limits.

### **Class II Compaction**

Class II compaction requires a specified procedure and does not measure the density or the voids.

Procedures for Class II compaction are as follows:

1. Establish a rolling pattern to verify adequate density.
2. At Engineer's option, cores or gauge readings at the frequency designated in Materials IM 204, Appendix F for the first day of placement will be used. The Engineer may modify the sample size and frequency provided the compaction is thorough and effective.
3. The Engineer will accept the rolling pattern based on the average test results. When the average of field voids is less than or equal to 8.0%, the pattern is considered thorough and effective.
4. When the average of field voids exceeds 8.0%, modify the rolling pattern. The Engineer may require additional testing until thorough and effective compaction is achieved.
5. For areas inaccessible to rollers, use mechanical tampers or other approved compaction methods.

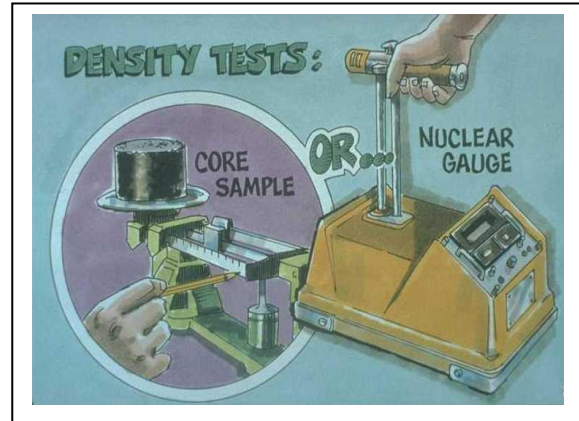

## Test Strips

(Specification 2303.03, C, 5;  
Construction Manual section 8.13)

Test Strips may be required under Class I compaction only, for the purposes of evaluating properties of the HMA mixes and for evaluating an effective rolling pattern. The current specifications contain the following test strip requirements:

- Construct a test strip of the surface mixture prior to its placement on the surface course for Interstate highways, Primary highways, and ramps connecting Interstate and Primary highways.
- Construct a test strip of the intermediate mixture at the start of its placement on the intermediate course for Interstate highways and Interstate-to-Interstate ramps.
- Test strips for base mixtures may be constructed but are not typically required. An exception would be for a base mixture placed as a surface course.
- Only one test strip will be allowed for each mixture. The Engineer may require additional test strips if a complying HMA mixture or rolling pattern is not established.
- The quantity of HMA mixture subject to test strip construction is pre-established with the Engineer and limited to one-half day's production.

Procedures for proper construction and documentation of test strips are outlined in *Section 8.13* of the Construction Manual.

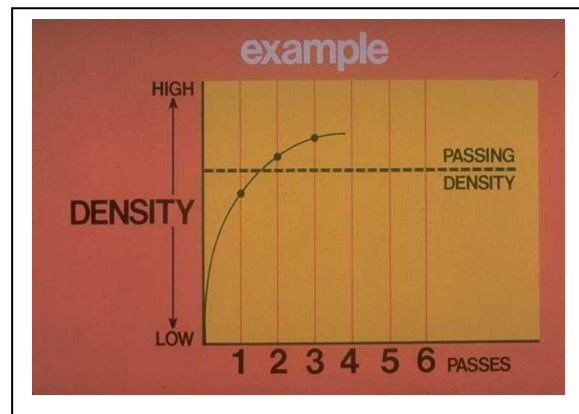
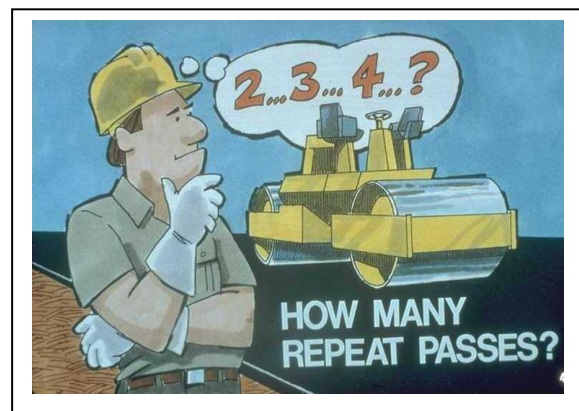
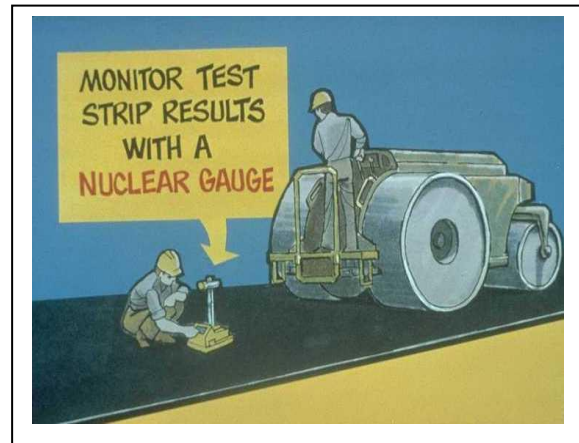

### **Checking Roller Coverage**

For Class I compaction, the number of roller passes will be determined by test strip required in situations discussed in the previous section. When a test strip is not required, the contractor will have to determine the number of roller passes to achieve the compaction effort necessary for the desired density. In this situation, the contractor would base their rolling pattern on previous experience working with the mixtures and equipment involved in the paving operation.

Further adjustments may be necessary after stable production is established.

For Class II compaction, the number of roller passes is determined by the process used to establish rolling pattern providing adequate density, meeting specification requirements. As with Class I compaction, previous experience working with mixtures and equipment involved could prove to be valuable in this effort.

Pay particular attention to the area at the end of one rolling area and the beginning of the next, to see that this area is not being over-rolled or under-rolled.

*Additional discussion of compaction procedures and roller operations are contained in Chapter 9 of this manual.*



**LIMITATIONS &  
MISC. OPERATIONS**

## VIII. Limitations and Miscellaneous Operations

### Warm Mix Asphalt

(Specification 2303)

Warm Mix Asphalt (WMA) refers to a group of technologies used to produce asphalt concrete mixtures at temperatures 50 degrees F or more below those typically used in production of HMA. Temperature reductions may be achieved through use of approved chemical additives, organic (wax-like) additives, or water injection systems. WMA technologies work to lower mix viscosity (resistance to flow), which promotes better aggregate coating during production, workability during placement, and compaction at reduced temperatures.



#### Advantages of using WMA

- Lower mix temperature.
- Reduced burner fuel use.
- Reduced plant emissions.
- Better working conditions, due to less heat and fumes.
- Acts as a compaction aid for stiff mixes or during cool weather.
- Increased time available to haul & compact mix.
- Less binder oxidation, leading to increased durability.



#### Challenges in using WMA

- Moisture control / removal issues.
  - Longer aggregate drying times.
  - Requires better stockpile management practices.
- Potential Instability / Rutting
  - Initial tenderness - may delay opening roadway to traffic.
  - Bump to stiffer binder grade to counteract.



## Chapter 8

### Conditions on WMA use

- WMA (vs. HMA) use is contractor option.
- WMA system used is subject to approval.
- Specifications include lower surface, production & placement temperature requirements for WMA (vs. HMA).
- Moisture sensitivity testing requirements (same as for HMA).

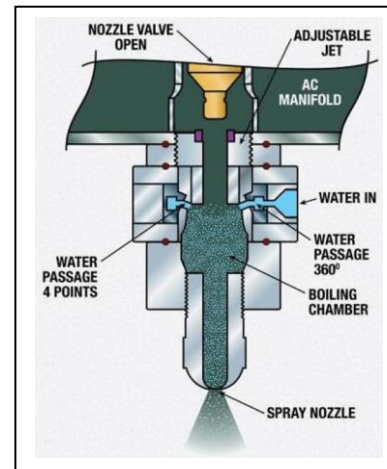

### Recycled Asphalt Shingles

(Specification 2303; Materials IM 505 & IM 506)

Use of ground Recycled Asphalt Shingles (RAS) in asphalt mixtures has increased in recent years, due to the rising cost of asphalt binder, the desire to reduce the volume of waste being sent to landfills, and improvements in shingle grinding / processing methods.

### Advantages of using RAS

- Reduced landfilling of shingles.
- Replaces raw materials in the mix.
- Cost savings.
- Desirable materials properties.
  - High binder content (20-30%).
  - Granular coating provides good frictional properties.
  - Lime dust acts as a natural anti-strip agent.
  - Fibers promote mix flexibility.



### Challenges in using RAS

- Harder asphalt binder in RAS - may require "bumping" to lower virgin binder grade.
- "Black Rock" effect (some asphalt binder remains in solid form, with no contribution to binder content).



## Chapter 8

- Chunks / clumping vs. fine (loose) grindings, often a result of stockpile exposure to high temperatures.
- Limited supply / suppliers for full-scale use.

### Conditions on RAS use

- RAS processed from pre-consumer (factory scraps) or post-consumer (tear-off) shingles.
- RAS certified by an approved supplier (listed in *IM 506*).
- Up to 5% RAS - by total weight of aggregate in the mix.
- Two-thirds (67%) credit for asphalt binder in RAS.



RAS is often used in combination with Recycled Asphalt Pavement (RAP). In this case, the RAS replaces an equal percentage of the allowable percentage of RAP in the mix.

RAS works hand-in-hand with Warm Mix Asphalt (WMA). In this situation, the slightly “harder” binder in the RAS is offset by the somewhat “softer” binder resulting from the WMA process.

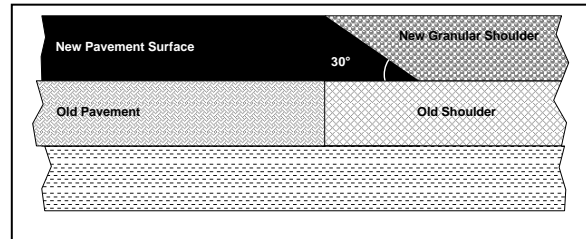

### **Safety Edge**

(*Specification 2305; Materials IM 502; Standard Road Plan PV-3*)

A Safety Edge is a beveled pavement edge to help lessen the severity of roadway departures. When a driver drifts off the paved surface, the Safety Edge provides greater ease of re-entering the roadway and reduces the risk of over-steering and subsequent loss of vehicle control.

The angle of the bevel is critical for the Safety Edge to function properly.



## Chapter 8

---

Measured from level, the bevel is 30 degrees. Adding in the pavement surface slope, the resultant angle is between 30 and 35 degrees.

The sloped pavement edge is produced by a “shoe” type device that attaches to the end of paver screed. The device confines the mix at the end gate and extrudes the material in a wedge shape. Approved devices are listed in *Materials IM 502*. Alternative devices may be approved by the Engineer, who may require proof that the alternative device will produce acceptable results.

A pavement section with a properly constructed Safety Edge does not require placement of a granular shoulder or temporary shoulder fillet (discussed later in this chapter) prior to opening the roadway to traffic.

### **Milled Shoulder Rumble Strips**

(*Specifications 2308 & 2548; Construction Manual 8.61; Standard Road Plan PV-12*)

Milling has become the standard method for installing rumble strips in HMA paved shoulders. The process utilizes a milling machine to produce shallow concave depressions in the HMA shoulder surface. The milled surface is then sealed with asphalt emulsion to prevent intrusion of water into the HMA shoulder.

*Standard Road Plan PV-12* illustrates configurations and details for shoulder rumble strips on Interstates, Expressways, and paved shoulders of two-lane roadways. The grinding pattern itself is the same for all three



## Chapter 8

---

situations, utilizing a standard width, depth, and spacing. Differences lie in the distance offset from the painted edge line and the “skip” pattern specified for two-lane roadways and the outside shoulder of expressways. Grinding dimensions and alignment of the pattern should be randomly checked and adjusted, if necessary. Rumble strips are typically placed on mainline HMA shoulders only, with the pattern omitted at specified locations near intersections and ramps & loops.



Milling equipment variations can result in differences in the rumble strip construction operation. The cutting head must be capable of providing a smooth cut, without tearing or snagging the HMA pavement. Multiple cutting heads and electronic controls can speed the process and eliminate variability in milling depth and pattern.



All loose material resulting from the milling operation must be removed from the shoulder on a daily basis. Some milling machines are equipped with a vacuum system to assist in this effort. Millings may be used as fillet material adjacent to the paved shoulder or may become property of the contractor and properly disposed of off the project. Specific plans may require the millings to be taken to a designated location.

Bituminous Fog Seal is used to coat the rumble strips and thereby reduce premature deterioration of the milled (open) surface. Undiluted asphalt emulsion is typically only placed on the milled rumble strips unless the contract documents call for its use in sealing the entire shoulder.

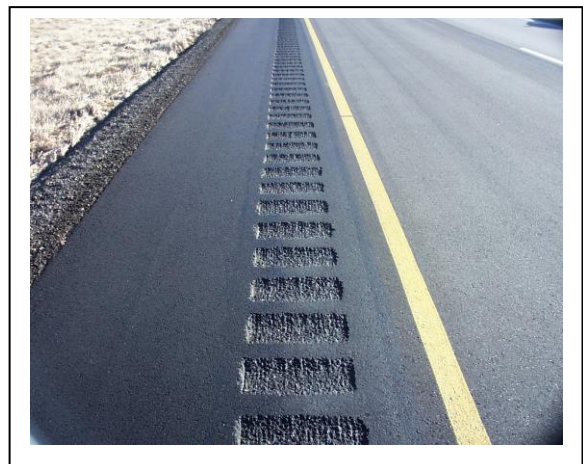

## Chapter 8

Additional equipment, material and construction requirements are included in *Specification Section 2548*, entitled “Milled Rumble Strips - HMA or PCC Surface”.

### **Milled Centerline Rumble Strips** (*Specification 2548; Construction Manual 8.62; Standard Road Plan PV-13*)

Milled centerline rumble strips are transverse concave depressions that are ground into the pavement surface, along the centerline of an undivided roadway. These devices can be installed on new or existing HMA or PCC pavements, utilizing similar milling equipment as for shoulder rumble strips. Using noise and vibrations, centerline rumble strips alert drivers whose vehicle is crossing the centerline that corrective action is needed.

A unique gapped milling pattern, consisting of skipping every third centerline cut, is used to provide a noticeable difference between the rumbling warnings of milled centerline rumble strips and milled shoulder rumble strips. Differentiating between the two is intended to break the conditioning of a driver to always veer left when traveling over rumble strips which, in the case of centerline rumble strips, would be the opposite of the desired effect.

*Standard Road Plan PV-13* shows configurations and details for milled centerline rumble strips. The milling pattern is gapped at the centerline joint to reduce water infiltration and potential pavement deterioration at the joint.

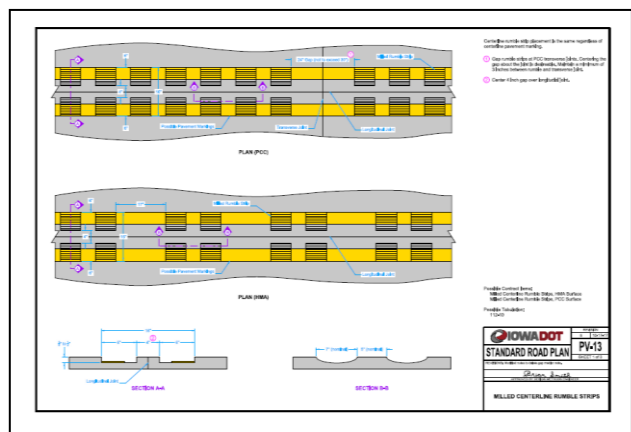

## Chapter 8

Alignment tolerances and other requirements are contained in *Specification 2548*.

Grinding dimensions and alignment of the pattern should be randomly checked and adjusted, if necessary. Centerline rumble strips are gapped at intersections and bridge approaches, as shown on *Standard Road Plan PV-13*.

As with shoulder rumble strips, milling equipment variations can result in differences in the centerline rumble strip construction operation. The cutting head must be capable of providing a smooth cut, without tearing or snagging the HMA pavement. Multiple cutting heads and electronic controls can speed the process and eliminate variability in milling depth and pattern. Similarly, all loose material resulting from the milling operation must be removed from the pavement surface and either used as fillet material adjacent to the pavement edge or properly disposed of off the project.

Unless specified otherwise in the contract documents, centerline rumble strips are not sealed with Bituminous Fog Seal. Since centerline paint markings are subsequently placed through milled areas, there are concerns that the fog seal will prevent adequate bonding of the paint to the pavement surface.

### **Granular Shoulders** (*Specification 2121*)

Type B granular shoulders are often specified adjacent to HMA pavements.

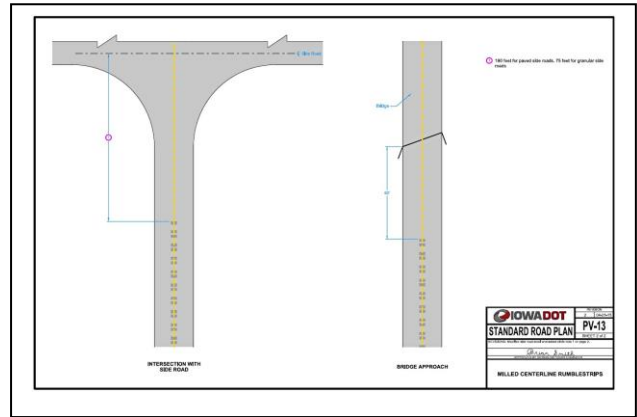



## Chapter 8

---

For resurfacing projects, additional granular material is added to existing shoulders to bring them up to the design cross section and eliminate drop-offs at the pavement edge. In some cases, earth fill is required prior to placing granular material.

Minimal surface preparation is generally required prior to placement of granular shoulder material. Existing vegetation is removed and deposited on the foreslope. Bituminous edge rut material and existing aggregate is salvaged and placed on the outer shoulder area.

Granular shoulder material is deposited directly on the shoulder for the width designated and shall not be dumped on the pavement. Blading granular material across the pavement will potentially damage / scar the surface. The aggregate is compacted with no less than four complete coverages of the entire surface with either a pneumatic tired roller or steel tired roller. One finish pass with steel roller follows. Additional moistening may be required if the aggregate is too dry to readily compact.

Placement of granular shoulders must be coordinated to bring up the shoulders adjacent to the paving operation before the lane may be opened to traffic. A fillet of granular material (minimum width six times the thickness of resurfacing completed) may be used to temporarily correct a drop-off created by resurfacing. Material used for the temporary fillet must be bladed across the width of the shoulder prior to placing the final layer of granular shoulder.



## Public Convenience and Safety (Specification 1107.08)

When it is not practical for the Contracting Authority to close the road for construction, the contractor will be expected to perform the work under traffic. The contract documents will indicate this fact and provide instruction on handling traffic through the work zone. If traffic is to be maintained through the project, the contractor shall conduct the work to assure the least possible obstruction to access by residents along the project, and to provide for the safety of workers and the traveling public.



Unless otherwise stated in the contract documents, all work shall be performed by the contractor between the hours of 30 minutes after sunrise and 30 minutes before sunset. Charts and tables of official daily sunrise and sunset times for locations throughout the state are readily available and may be used as a basis in determining specification compliance.

The contractor's machines and equipment should all be in good mechanical condition. This should also include all safety guards required for the equipment. This is for the protection of workers and inspection staff in the immediate area, as well as the nearby traveling public.

The condition of the haul roads used by the contractor should also be inspected. The contractor has the responsibility to maintain dust control on these roads, and the inspector has the responsibility to assure they do so.

Day	Jan.	Feb.	Mar.	Apr.	May	June	July	Aug.	Sept.	Oct.
01	0743 1654	0727 1729	0650 1805	0587 1860	0510 1913	0441 1948	0431 1954	0508 1933	0540 1848	0611 1756
02	0743 1655	0726 1731	0648 1804	0556 1841	0509 1914	0441 1948	0443 1954	0509 1932	0541 1846	0612 1754
03	0743 1655	0725 1732	0646 1807	0554 1842	0508 1914	0440 1948	0444 1954	0510 1931	0542 1845	0614 1753
04	0743 1656	0724 1733	0645 1808	0552 1843	0506 1917	0440 1948	0444 1953	0511 1930	0543 1843	0615 1751
05	0743 1657	0723 1734	0643 1809	0550 1845	0505 1918	0440 1947	0445 1953	0512 1928	0544 1841	0616 1749
06	0743 1658	0722 1736	0643 1811	0549 1846	0504 1919	0439 1947	0445 1953	0513 1927	0545 1840	0617 1748
07	0743 1659	0721 1737	0640 1812	0547 1847	0503 1920	0439 1948	0446 1952	0514 1926	0546 1838	0618 1746
08	0742 1700	0719 1738	0638 1813	0545 1848	0502 1921	0439 1948	0447 1952	0515 1925	0547 1836	0619 1744
09	0742 1701	0718 1740	0637 1814	0544 1849	0500 1922	0439 1949	0447 1952	0516 1923	0548 1834	0620 1743
10	0742 1702	0717 1741	0635 1815	0542 1850	0459 1923	0438 1950	0448 1951	0517 1922	0549 1833	0621 1741
11	0742 1704	0716 1742	0633 1816	0541 1851	0458 1924	0438 1950	0449 1951	0518 1920	0550 1831	0622 1739
12	0741 1705	0714 1743	0631 1818	0539 1852	0457 1925	0438 1951	0450 1950	0519 1919	0551 1829	0624 1738
13	0741 1706	0713 1745	0630 1819	0537 1853	0456 1926	0438 1951	0450 1950	0520 1918	0552 1827	0625 1736
14	0741 1707	0712 1746	0628 1820	0536 1855	0455 1927	0438 1951	0451 1949	0521 1916	0553 1826	0626 1734
15	0740 1708	0710 1747	0626 1821	0534 1856	0454 1928	0438 1952	0452 1948	0522 1915	0554 1824	0627 1733
16	0740 1709	0709 1749	0625 1822	0532 1857	0453 1929	0438 1952	0453 1948	0523 1913	0555 1822	0628 1731
17	0739 1710	0708 1750	0623 1823	0531 1858	0452 1930	0438 1953	0454 1947	0524 1912	0557 1820	0629 1730
18	0739 1712	0706 1751	0621 1824	0529 1859	0451 1931	0438 1953	0455 1946	0525 1910	0558 1819	0630 1728
19	0738 1713	0705 1752	0620 1824	0528 1900	0450 1932	0438 1953	0455 1946	0524 1909	0559 1817	0631 1727
20	0737 1714	0703 1754	0618 1827	0526 1901	0449 1933	0438 1953	0456 1945	0527 1907	0600 1815	0632 1726
21	0737 1715	0702 1755	0616 1828	0525 1902	0448 1934	0439 1954	0457 1944	0528 1906	0601 1813	0634 1724
22	0736 1717	0700 1756	0614 1829	0523 1903	0448 1935	0439 1954	0458 1943	0530 1904	0602 1812	0635 1722
23	0735 1718	0659 1757	0613 1830	0522 1904	0447 1936	0439 1954	0459 1942	0531 1903	0603 1810	0636 1721
24	0735 1719	0657 1759	0611 1831	0520 1906	0446 1937	0440 1954	0500 1941	0532 1901	0604 1808	0637 1719
25	0734 1720	0656 1800	0609 1832	0519 1907	0445 1938	0440 1954	0501 1940	0533 1900	0605 1806	0639 1718
26	0733 1722	0654 1801	0607 1833	0517 1908	0445 1939	0440 1954	0502 1940	0534 1899	0606 1805	0640 1716

## Chapter 8

---

If any violations of the specifications or any safety problems are noticed, the inspector should notify the contractor immediately. The grade inspector should also notify the inspector in charge of the project as soon as possible.

Any violations or problems and conversations with the contractor about them should be noted in the inspector's diary.

### **Haul Roads**

*(Specifications 1105.13 & 1107.07;  
Construction Manual 2.12)*

A haul road is the designated road on which the contractor is to haul material to the grade from the plant or supplier. There are many considerations given to a road before it is declared a haul road. The structure of the road, weight restrictions of structures, traffic signing, and other aspects are reviewed before a road is declared a haul road. An agreement is reached with the affected entity (city or county) before its roadways are used as designated haul roads.



There will be occasions when the haul road will not be the most direct route for the contractor to take and, consequently, they may want to use a different road. It is the responsibility of the both the grade inspector and plant monitor to ensure the contractor is using the designated haul road. If the contractor is allowed to use different roads than those designated as haul roads, the county or city that owns the road will most likely seek damage considerations.

## Chapter 8

---

*Specification Article 1107.07, "Safety, Health, Pollution, and Sanitation", and Construction Manual Section 2.12* explain when and how dust control should be maintained. These items should be reviewed before operations begin.

### **Mat Surface Conditions**

*(Specification 2303.03, C, 4)*

HMA mixtures shall not be placed on a wet or damp surface. An HMA overlay placed on a wet or damp surface may result in a slippage or sliding-type failure of the overlay. This failure mode, which usually shows up relatively quickly, requires removal and replacement of the affected overlay.

Clearly, HMA placement should not start if wet conditions exist or rainfall is imminent. The major issue is what to do if rain begins at some point during paving. Some contractors expect to be able to place the remaining "trucks on the road" despite wet conditions. The contractor should not be allowed to place HMA under wet or damp conditions simply because the trucks have already been loaded. Contractors must take a proactive approach in assessing the weather conditions with forecasts, radar, etc., and adjusting their operations accordingly. This includes slowing or stopping the plant as rain approaches to minimize loads arriving at the paver after rain begins.

There is still some room for judgement on the part of the field inspector. If the rain has temporarily stopped and using a broom and/or air compressor can



## Chapter 8

artificially dry the surface, then waiting load(s) can be placed. This assumes the temperatures of the road surface and hot mix have remained above the respective specification minimums, the tack coat remains in place and undamaged, and that placement and compaction can take place prior to additional rains.

### **Surface Temperature**

*(Specification 2303.03, C, 4)*

HMA mixtures shall not be placed when temperature of the shaded portion of the roadway surface is less than shown in the tables within the specification listed above. The tables provide minimum surface temperatures based on thickness and location of the lift to be placed. The project engineer may further limit placement when other conditions exist that are considered detrimental to quality work. An example of this situation is when the temperature is near the minimum and wind is significant.



### **Mat Cooling**

*(Construction Manual Section 8.55 & Appendix 8-2; PaveCool software)*

Base temperature is the single greatest factor in the rate of cool down for freshly placed HMA mat. Consequently, base temperature has direct affect on recommended minimum laydown temperature and rolling time available to obtain specified density. The tables in *Construction Manual Appendix 8-2* illustrate this relationship.

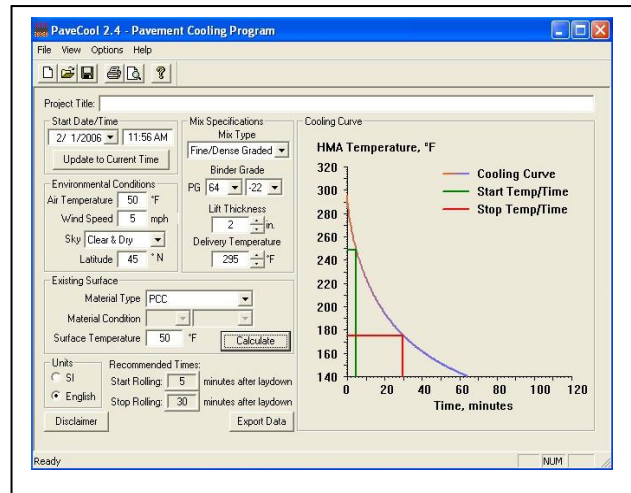

## Chapter 8

Wind velocity, air temperature, and cloud cover are additional factors that affect the cooling rate of HMA.

*PaveCool* is a software program, developed by the Minnesota Department of Transportation and Minnesota Asphalt Paving Association, used to determine approximate cooling rates for hot mix asphalt pavement under various conditions. The program uses numerous variables to graph cooling curves and provide a resulting “time available for compaction” following mix laydown.

The latest version of the *PaveCool* software is currently available to download through links provided under “Hot Mix Asphalt (HMA)” on the Construction & Materials Bureau websites found on DOTNET (for DOT network users) and the worldwide web (www). A *PaveCool* link is also provided within *Construction Manual Section 8.55* text on the Electronic Reference Library (ERL) version.

This program is not intended to replace good engineering judgement; rather, it is a tool to provide the user with insight on how actual climate conditions affect the time available for compaction of HMA mixtures. Results can be used to decide when to pave and/or make compaction operation adjustments.

### **Mix Temperature**

(Specification 2303.03, C, 3)

The mix temperature is usually established at the plant. It is important to know what the minimum, maximum and intended temperatures are for the mix you plan to use.

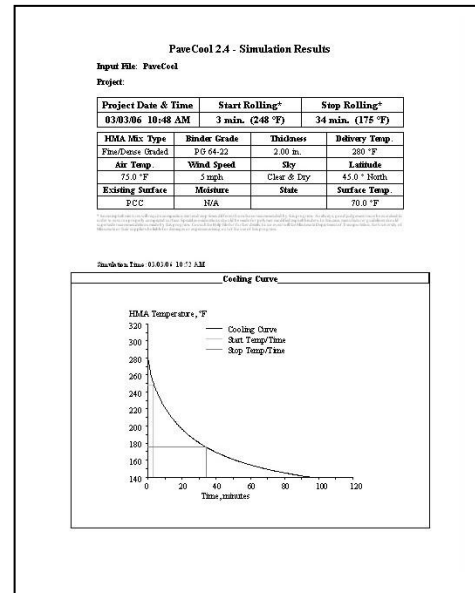

### Minimum Temperature

The minimum HMA temperature for placing a nominal layer thickness of 1-1/2 inches or less is 245 degrees F. The minimum HMA temperature for placing a nominal layer thickness greater than 1-1/2 inches is 225 degrees F. For WMA, the minimum production temperature is 215 degrees F. A mix temperature that is too low will allow the mat to crack and tear under rolling operations. Also, specified compaction and mat density will be hard to achieve if mix temperature is too low.

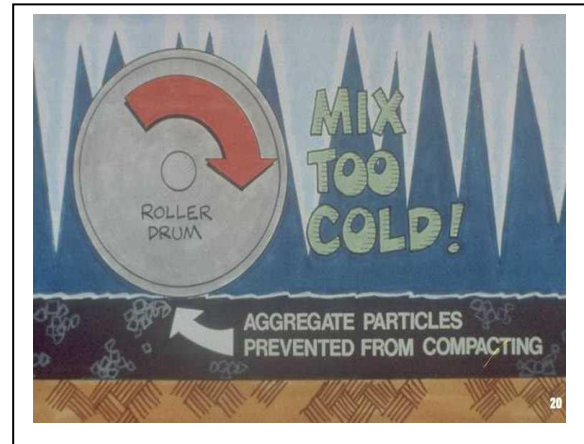

### Maximum Temperature

The maximum production temperature of HMA is 330 degrees F, unless otherwise approved by the Engineer. For WMA, the maximum temperature is 280 degrees F (up to 330 degrees F allowed after October 1<sup>st</sup>). Overheating a mix may burn the "oil" in the mix and produce a mix with undesirable properties. The appearance of blue smoke rising from a loaded delivery truck is indication of an overheated mix.

A mix temperature that is too high may also lead to shoving and blistering of the mat during rolling operations.

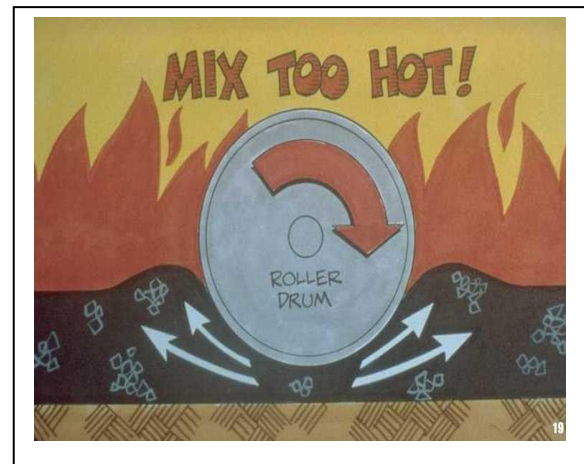

### Temperature Consistency

Consistent mix temperature is essential for uniform compaction of the mat. The plant must be operated so that the temperature of the mixture at discharge does not vary by more than 20 degrees F.

Locations for taking mix temperature readings include:

- Plant Site
- Truck Box

- Mat, directly behind the paver  
(readings should be taken every  
2 hours and recorded)

### **Calendar Dates**

*(Specification 2303.03, C, 4)*

HMA mixtures shall not be placed after November 15, except with approval of the Project Engineer. Placement of wearing (surface) courses one inch or less in design thickness may be further restricted by the contract documents or Project Engineer.

### **Cold Weather Paving**

*(Specifications 2303.03, F, 2303.04, H, & 2303.05, H; Construction Manual Sections 8.55 & 8.70)*

Cold Weather Paving is defined as HMA paving when road surface and air temperatures are below the minimums specified in *Specification Section 2303*. The Engineer may consider allowing the work to proceed if the Contractor's written "Cold Weather Paving Plan" provides enough justification to be considered valid and accepted for use.

The Cold Weather Paving Plan documents material, operational and equipment changes for paving when temperatures are lower than specified. The plan must specify an approved mix design that includes warm mix additive (other than water injection). Warm mix additive allows the mix to remain flexible at lower temperatures, increasing the time available for compaction. Similarly, the plan must outline equipment and operational changes that will enable



adequate compaction within the anticipated time available.

The Engineer's written acceptance of the Cold Weather Paving Plan is required. The Engineer's acceptance does not relieve the Contractor of responsibility for quality of HMA pavement placed in cold weather.

### **Winter Shutdown**

*(Specifications 2121.03, C, 2214.03, D, 2303.03, C, 6, 2318.03, J, & 2527.03)*

Projects are sometimes required to have a winter shutdown period. This may be planned, such as with a multi-year project when all work can not be completed in one season. For other projects this may be the result of delays due to weather, availability of materials, or project timing itself. The recent increase in projects with winter shutdown has necessitated additional specification requirements to address the following issues.

#### **Granular Shoulders**

Granular shoulder material shall be brought up to the pavement edge for the full width of the shoulder, at the design cross slope, prior to winter shutdown. This serves to increase safety to the traveling public as well as assist necessary winter maintenance operations.

#### **Scarification**

When resurfacing is part of the contract, all scarified surfaces shall be covered with at least one full lift of HMA prior to winter shutdown. The HMA provides a safer roadway surface and protects the

existing pavement from damage during the winter.

### **Headers**

Headers, when required to end paving for winter shutdown, shall be located across from each other.

### **Temporary Runouts**

When required to end paving for winter shutdown, runouts shall be located adjacent to each other. The runout shall be 25 feet in length per 1 inch of lift thickness. The runout shall be removed before paving resumes. The additional runout length provides increased safety to drivers during the extended shutdown period versus the 10' temporary (end of day) runout.

### **Cold In-place Recycling**

When resurfacing is part of the contract, all cold in-place recycled surfaces shall be covered with at least one full lift of HMA prior to winter shutdown. The HMA seals and protects the recycled surface from damage and deterioration during winter.

### **Pavement Markings**

The specifications require that pavement markings be completed before the roadway is open to traffic (or within a limited number of working days after the roadway opening, depending on the marking type). This requirement also applies to placement of edge lines and symbols prior to winter shutdown. The contractor is typically paid the unit bid price for the additional pavement marking quantities required. This increases safety by providing necessary guidance to the traveling public during a winter suspension period.

### **Tickets, Quantities, and Yield**

*(Specification 2001.07)*

#### **Tickets**

Tickets must accompany every load of HMA to be used as documentation. The ticket should show the project number, mix type, mix design number, date, and tons represented. Tickets for projects with quantities over 10,000 tons of asphaltic mixtures must be automatically printed.

#### **E-Ticketing**

New procedures are being developed which will replace paper tickets with electronic load tickets. The so-called "E-Tickets" will contain all information from the current paper load tickets, with potential for much more related information.

E-tickets offer advantages over paper tickets, which may be damaged or lost. More importantly, E-tickets improve worker safety by not requiring inspectors or workers to walk between haul trucks and paving equipment to collect paper tickets. E-ticketing specifications will be added to selected trial projects and phased-in over the next several years.

#### **Quantities**

Check project plans for design quantities based on design weights, thickness, width, and lengths. Look for extra quantities required for fillets, crown correction, and irregularities. Check and double check the quantities of mix used on the road and verify the totals with the plant daily. Quantities must be watched carefully for over / under-runs which may affect overall project budget or resulting work quality.

### **Yield**

Yield is a measure of the area of pavement, of known thickness, that will be produced by a quantity of hot mix asphalt. If mat width is known, yield determines the distance a known quantity of hot mix will pave. This information tells the inspector many things, including how far each truckload of hot mix will pave and, more importantly, alerts the inspector that the average design thickness is being exceeded which may result in a quantity overrun.

The term “yield” is often used when referring to the comparison of the actual quantity of hot mix asphalt incorporated into the project versus the design quantity shown on the plans for a given portion of the work. In this case, yield is usually expressed as a percentage of plan quantity. Similarly, yield calculations can be made for other project items, such as emulsion for tack coat / fog seal, and shoulder rock.

It is recommended that the HMA yield be checked every 2 hours. Calculate the tons required per station for various widths of pavement that will be laid prior to the start of paving. All calculations should be based on the design weight (145 lbs. per cu. ft. or as shown otherwise in the plans). Keep daily yields as well as cumulative (to-date) yields. To avoid surprises at the end of the project, it is advisable to occasionally project the final yield by totaling the quantity used to date with the calculated remaining quantity to be placed and comparing this total to the project (plan) quantity.

### **Contractor Sampling**

*(Specifications 2303.03, D, 3 & 5;  
Materials IM's 204, 301, 322, 323;  
Iowa DOT Form 193)*

Uncompacted hot mix asphalt (hot box) samples are taken behind the paver and ahead of the rollers. For a typical project, the contractor is responsible for field sampling. The project inspector or monitor must direct and witness sampling to ensure that samples are timely and taken properly, by appropriately certified personnel.

The first production sample each day shall be randomly obtained within the first 500 tons of mix produced. However, the first sample should not be taken from the first 100 tons of HMA produced for the day, to allow plant production to stabilize prior to sampling. Subsequent daily samples will be randomly obtained from the remaining daily production as indicated in *Table 2303.03-4 (Uncompacted Mixture Sublot Size)* of the specifications. A maximum of five paired hot box samples (sublots) per day are obtained by the contractor. The contractor may request to have a quality control plan that indicates a higher testing frequency, if approved by the engineer at preconstruction meeting. Contractors may, at their discretion, obtain and analyze additional samples of plant produced mixture. This practice is encouraged and will allow better product quality control because of the additional information provided. However, only the information obtained from samples selected at random and designated as "production samples" will be used for specification compliance and included in the moving averages.

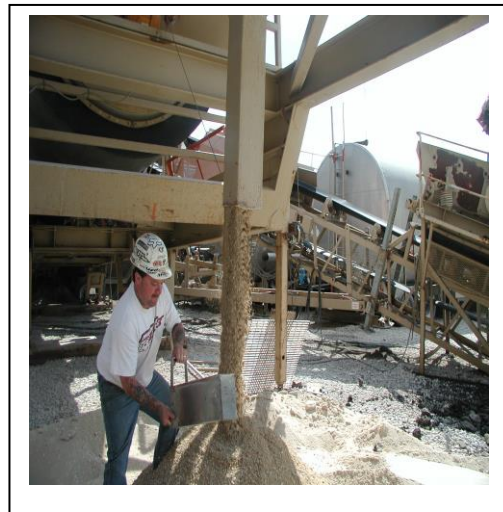

## Chapter 8

The inspector or monitor is typically required to direct and witness contractor sampling of other materials, such as aggregates and asphalt binder. The methods and procedures for sampling are given in applicable Materials IM's and are also taught in required Iowa DOT certification courses. Minimum sampling frequencies are as stated in *IM 204*. All sampling done for project acceptance purposes must be directed and witnessed by the inspector or monitor.



Whenever possible, the inspector or monitor should accommodate contractor requests for additional sample witnessing beyond minimum requirements.



The inspector must properly identify samples (using *Form 193*) and use tamper-proof security measures if custody of the samples is not maintained by the contracting authority. This situation commonly occurs when the contractor or other courier service transports the samples to the lab for testing.

### Coring

(Specification 2303.03, D, 5; Materials IM's 204, 320, 321 & 337; Construction Manual section 8.13)

The contractor cuts samples from any HMA course or finished HMA pavement for tests to determine field density (voids), thickness, and/or composition (when appropriate). The inspector identifies the limits of each section (sublot) and marks the random location of each core.

RANDOM CORE SAMPLES				Enter Number of Cores Desired for Each Section Below	
PROJECT	EXAMPLE	MAT THICKNESS	2.00	IN.	
COURSE LAD	Intermediate	MAT (SLAB) WIDTH	12.0	FT.	
DATE LAD	12/12/07	DATE CUT	3/12/07		
STATION	350.00	TO STATION	372.50	=	2250 L.F. 15% 1
STATION	452.00	TO STATION	482.25	=	3025 L.F. 20% 2
STATION	520.85	TO STATION	615.75	=	9490 L.F. 62% 4
STATION	622.00	TO STATION	627.75	=	575 L.F. 4% 3
		TOTAL		=	15340 L.F. (DAY'S LOT)
	15340	L.F.	DIVIDED BY 7 SAMPLES	=	2191 L.F. (PER SUBLOT)
CORE #1:	2250	X	0.108	=	243 = STA. 350.00 = STA. 382.43
	10.0	X	0.887	+ 1.0 =	8.9 FT. (OrMax)
CORE #2:	1515	X	0.883	=	1333 = STA. 452.00 = STA. 482.33
	10.0	X	0.814	+ 1.0 =	8.1 FT. (OrMax)
CORE #3:	1515	X	0.210	=	318 = STA. 487.13 = STA. 488.98
	10.0	X	0.486	+ 1.0 =	8.0 FT. (OrMax)
CORE #4:	2375	X	0.541	=	97 = STA. 520.85 = STA. 521.82
	10.0	X	0.258	+ 1.0 =	5.1 FT. (OrMax)
CORE #5:	2375	X	0.271	=	643 = STA. 544.58 = STA. 551.01
	10.0	X	0.800	+ 1.0 =	8.0 FT. (OrMax)
CORE #6:	2375	X	0.567	=	2103 = STA. 568.30 = STA. 581.33
	10.0	X	0.570	+ 1.0 =	8.7 FT. (OrMax)
CORE #7:	2375	X	0.114	=	271 = STA. 592.03 = STA. 594.73
	10.0	X	0.485	+ 1.0 =	8.8 FT. (OrMax)
MAT TEMPERATURES				HMA (MIN) REPORT	
7:00am	275	1:00pm	285	TOTAL TONS	2,890
8:00am	285	3:00pm	285	- TONS WASTED	15
11:00am	285	5:00pm	275	= TONS USED	2,875
				+ PREVIOUS TONS	12,500
				= TONS USED TO DATE	20,000

## Chapter 8

Computer programs and spreadsheets are available to assist inspectors in determining random core locations. The latest version of "Random Core Location Program," is available for download from Office of Construction & Materials websites on DOTNET and worldwide web (www).

Unless specified otherwise, the sampling frequency shall comply with *Materials IM 204*. Specifications require eight samples to be cut from each lot of mat construction (an independent lot of eight samples are also taken for test strips). The contractor may request to have a quality control plan with a higher testing frequency, at no additional cost to the Contracting Authority, if preapproved at the preconstruction conference.

The contract documents may also require additional samples be taken directly on the longitudinal joint between adjacent lanes. These longitudinal joint cores, when required, shall be evaluated separately from the eight mat cores. The sampling procedure, frequency and lot size for longitudinal joint cores shall be as specified in contract documents. The inspector directs and witnesses core drilling and, when applicable, determines and records core lengths. The core sample should then be inspected (for defects and appropriate length) to determine if it is a representative sample and valid for testing. If not, the original core should be discarded, and a replacement sample taken.

Transportation of cores to the lab for testing should be coordinated with the plant monitor, such that custody of the

**CENTERLINE JOINT RANDOM CORE SAMPLES version 1.07**

**Notched Wedge Joint**      **Vertical (Butt) Joint**

Joint Location (Visible Seam)      Joint Location (Visible Seam)

0' Core Location      0' Core Location

**Excluded areas:**

- Areas where one side of the joint is formed by existing pavement not constructed under the contract.
- Areas where one side of the joint is cut on the existing surface.
- Areas within 1 foot longitudinally of an obstruction during construction of the surface course (curbside, side gutter, drainage, bridge abutments, curbs, etc.). Should a random sample location fall within 1 foot of such an area, the Engineer shall select an alternate nearby location away from the obstruction.
- Small areas, such as interchanges, gate areas or transitions, or obstructions the Engineer determines paving and finishing methods do not allow for consistent longitudinal joint construction.

**Notes:**

- Use the first eight feet length for Segments when:
- On lot of matching Test Strip
- The project has multiple lanes
- Portion of total length are multiple (included areas)
- More than 1 single joint is created (more than 2 through lanes per direction or a middle turn lane)

**PROJECT COURSE SURFACE**

MAT THICKNESS (in):

Segment	Route	Direction	Lane	MAINLINE FROM Station	MAINLINE TO Station	Length (ft)	First Day (Test Strip?)
1	80100	EB	1	1.00	20.00	1,900.00	Y
2	80100	EB	2	1.00	20.00	1,900.00	Y
3	80100	WB	1	40.00	60.00	2,000.00	N
4	80100	WB	2	40.00	60.00	2,000.00	N
5	80100	WB	3	40.00	60.00	2,000.00	N
6	80100	WB	4	40.00	60.00	2,000.00	N
7	80100	WB	5	40.00	60.00	2,000.00	N
8	80100	WB	6	40.00	60.00	2,000.00	N
9	80100	WB	7	40.00	60.00	2,000.00	N
10							N
11							N
12							N
13							N
14							N
15							N
16							N
17							N
18							N
19							N
20							N
Total = 99,800.00							

Non-Test Strip Length: 99,800.00  
Test Strip Length: 3,800.00  
**Total Length: 99,800.00**

Number of Non-Test Strip Sublots: 39  
Number of Test Strip Sublots: 5  
**Total Sublots: 44**

**Notes:**

- On the day when the surface joint has been completed (paved) at these locations, sample, test, and report.

Core	Segment	Route	Direction	Lane	Station	Core	Segment	Route	Direction	Lane	Station
1	1	80	EB	1	7.00	29 (Test Strip)	48				
2	1	80	EB	1	8.00	11 (Test Strip)	49				

0' x 3' x 1' Sublots: 39      0' x 3' x 1' Test Strip: 5      0' x 3' x 1' Core: 44



## Chapter 8

---

samples by the contracting authority is maintained. If transported by others, the samples must be properly identified and secured.

Unless the contract documents indicate otherwise, core density (field voids) testing is performed by the inspector or plant monitor. The testing is typically done in the project field lab, using the contractor's test equipment. Contractor personnel assist in preparing (sawing, etc.) the core sample for testing. Testing personnel must be properly trained and certified for the testing duties required.

Density testing requirements are given in *Materials IM 321*.

The specifications also describe a statistical procedure for field density (voids) evaluation, together with a schedule and corresponding formulas for determining payment adjustments for the lot. The project inspector should become familiar with the specification requirements, as well as the inspection procedures for compacted HMA samples outlined in *Construction Manual Section 8.13*.

### **Smoothness Testing**

(*Specifications 2316 & 2317; Materials IM 341; Construction Manual section 8.14*)

The requirements for pavement smoothness are outlined in *Specification Sections 2316 and 2317*. Pavement smoothness is evaluated for all primary and interstate mainline pavement surfaces, except when specifically excluded by the contract documents.





Smoothness may be measured with a 25-foot California type profilograph, which produces a profilogram (profile trace) of the surface tested, or high speed profilograph equipment, which has become the preferred choice for higher production projects.

The method of testing using the profilograph (and interpretation of the profile trace) is outlined in *Materials IM 341*.

The results of smoothness testing are used as a basis for incentive payments to the contractor or price reductions, as appropriate. The results are also used to determine whether corrective actions, such as grinding bumps or replacing pavement, are required.

The contractor should use a profilograph, in lieu of rolling surface checker or straight edge, to check additional pavement areas for bumps.

The contractor should test directly behind the finish roller, to allow correction of an identified ½ inch bump by re-rolling while the mixture is still hot enough to be affected. Any resulting mixture build-up on the wheels should be regularly removed.

**PROBLEMS &  
SOLUTIONS**

## IX. Problems and Solutions

### Segregation

(Specification 2303.03, C, 4;  
Construction Manual sections 2.53 &  
Appendix 2-34)

Segregation in hot mix asphalt is a non-uniform distribution of various aggregate sizes throughout the mass. The finished mat has a varied texture and may not meet specification requirements for surface texture, smoothness, or density. Severely segregated pavements require maintenance sooner than properly constructed ones because of excessive moisture damage, raveling, and premature cracking. The primary types of segregation include Truckload Interval, Random, and Longitudinal. Each type of segregation is the result of a specific action in mixing, delivery, and placement operations.



### **Truckload Interval Segregation**

Truckload interval segregation may be seen as crescent or chevron shaped spots (sometimes called “wings”) at the beginning and ends of truckloads. This type of segregation has many potential causes. The most prevalent cause is improper loading of the haul truck at the plant. If mix is placed in the truck bed in one drop from the silo, the coarse aggregate particles in the mix have a tendency to run to both the front of the bed and to the back tailgate. The situation is aggravated by the plant operator continuously opening and closing the silo gates to dribble mix into the truck and “top off” the load. For a tandem-axle truck, this problem is solved by using multiple drops of mix:

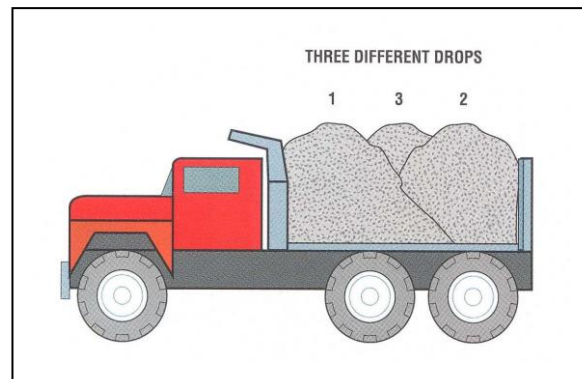

## Chapter 9

First, into the front of the truck; then, into the back of the truck; and finally, into the center of the truck bed. Additional drops are made if a larger truck is used. Truck unloading, particularly by raising the truck bed slowly while dumping, can contribute to a segregation problem. The truck bed should be partially elevated before the tailgate is released. This permits the mix to move in mass and to flood the hopper, thus preventing the coarse aggregate from falling out first and causing spotty segregation patterns. Paver operation can also be a cause of load interval segregation. Dumping the paver wings, thus sending coarser material to the middle of the hopper, after running the paver dry and then moving forward before the hopper is recharged can create this form of segregation. If the paver wings are lifted, it should only be done slowly with other non-segregated material in the feeder area, and only enough to keep the mix in the wings “alive”. That is, the mix in the corners of the hopper should not be allowed to cool before being moved to the center of the hopper. This will give the coarse material an opportunity to blend with more homogenous material, thus minimizing the segregation effect. Never allow the paver operator to bang the hopper wings to loosen crusted mix!

### Random Segregation

Random segregation consists of areas of coarse aggregate, sometimes referred to as “rock pockets”, that occur randomly across the length and width of the mat. Random segregation is often a result of improper handling of the aggregates in the stockpile and cold-feed bins at the hot mix asphalt plant. Rock pockets or random segregation

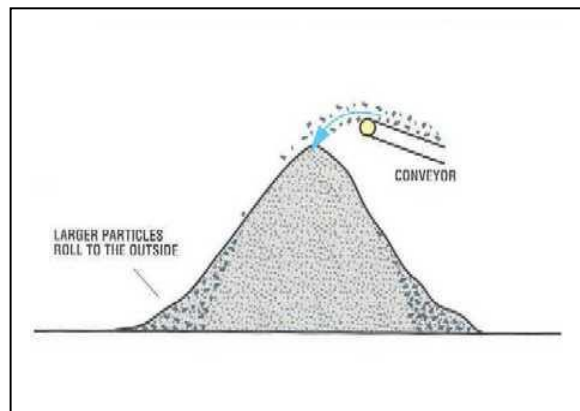

## Chapter 9

can occasionally be found on the roadway when the mix is manufactured in a drum mix plant. If the loader operator places a bucketful of segregated aggregate in the cold-feed bin, that material can pass through the drum, surge silo, haul truck, and paver without being completely mixed in with the other aggregates. Random segregation seldom occurs with a batch plant, as the screens and hot bins recombine the segregated material before it is fed to the pugmill. The pugmill further blends the aggregates and eliminates any segregation that may have existed previously. Proper materials handling at the plant can greatly reduce the incidence of this form of segregation.

### Longitudinal Segregation

Most longitudinal or continuous forms of segregation can be linked to the paver and, in particular, the material handling system. A longitudinal, segregated strip often develops in the center of the paved lane under the center screw conveyor (auger) support. Segregation is caused by a lack of material and the resulting coarse aggregate “roll down” into the center portion of the mat. This problem has been reduced in newer systems, which permit the conveyors to be raised, allowing unrestricted flow of material into the center area. Also, kickback paddles or reverse-flow augers may be incorporated to redirect mix to the center gearbox area. Following are other areas of the paver where segregation can be a problem: outside edges of the flight feeders, under the outboard screw conveyor supports, and the outer edges of the screed. Most segregation problems in these cases are due to a lack of material flowing to

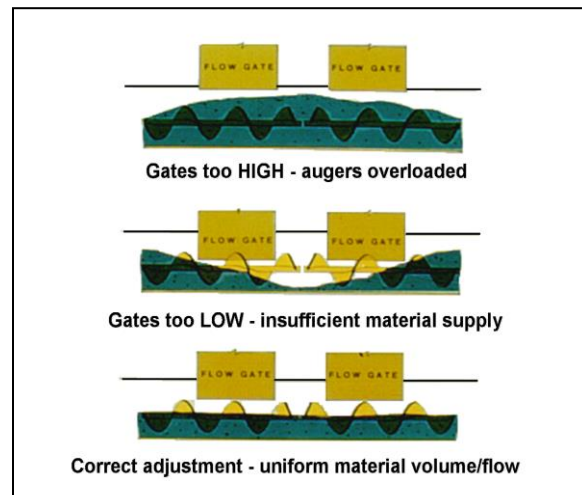
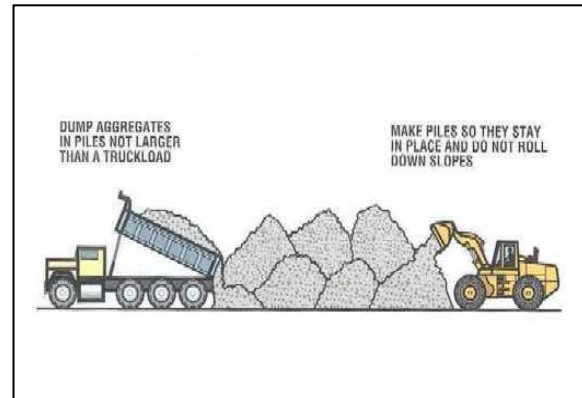

## Chapter 9

the areas in question. This may be a result of excessive wear or improper adjustment of the paver's material handling components, combined with the inability of a particular mix to flow. The paver must be properly maintained and operated such that an adequate and consistent head of material is delivered to all locations.

Segregation is observed in the newly laid mat immediately behind the paver and after rolling. Drive a newly placed mat in the early morning, late evening, or when the mat is wet. Segregation may show up more clearly under these conditions. When you think segregation is evident, corrective action should be taken immediately. Notify the contractor and your immediate supervisor as soon as possible.

*Construction Manual Appendix 2-34 (K.1) and Appendix 2-34(K.2) help define and give guidance for making segregation price adjustments.*

### **“Temperature” Segregation**

Temperature differentials in hot mix asphalt can lead to some of the same problems as mixture segregation. The temperature differentials, in transverse or longitudinal direction, may be caused by delays at the plant or in trucking operations. Improper paver operation and inconsistency in the placement process can also contribute to temperature gradients, especially across the width of the mat. These variations in mat temperature lead to inconsistent compaction, resulting in waves and poor ride quality. A lack of density in the cooler areas of the mat ultimately leads to premature deterioration of those pavement areas.

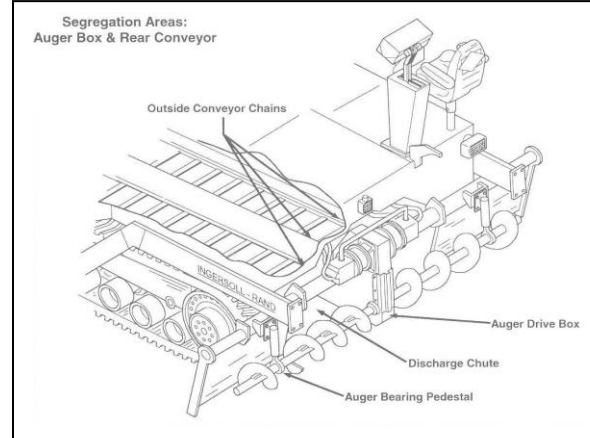

## Chapter 9

The best way to avoid temperature segregation is with a consistent paving operation. Frequent temperature monitoring, both at the plant and behind the paver, may reveal sources of inconsistencies in mat temperature. Thermal imaging (infrared) cameras are available that can detect temperature gradients in freshly placed HMA. Though not specified in Iowa, some states do require use of infrared cameras to monitor consistency of mat temperature and quickly identify problems as they develop.

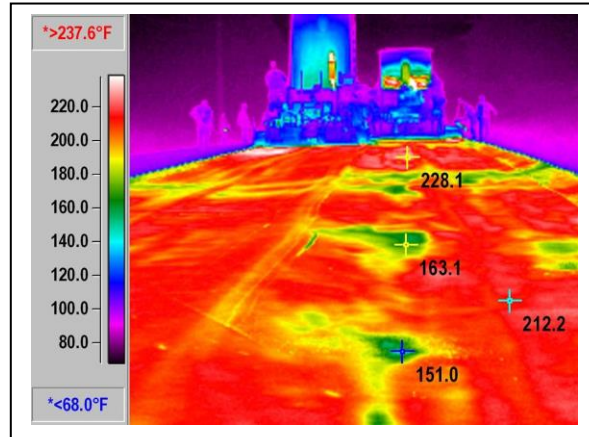

### **Tack Coat Application**

As stated previously in this manual, the purpose of tack coat is to ensure a bond between the existing pavement surface and the new hot mix asphalt overlay. A good bond can increase the overall structural strength of the pavement and prevent intrusion of water between the layers. If a good bond is not formed between the existing surface and the new overlay, a slippage or sliding-type failure can occur.

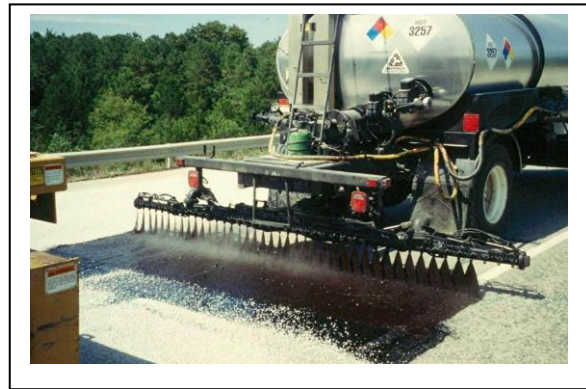

Three main areas of emphasis have emerged in recent years that must be followed to ensure a tack coat has been properly applied and will likely function correctly: Tack Coat Application Rate, Uniform Tack Coat Application, and Breaking of Tack Coat.

#### **Tack Coat Application Rate**

The amount of tack coat applied to the surface to be overlaid is very important. Too little tack coat can result in no bond between pavement layers. Too much tack coat promotes slippage or sliding



between layers and bleeding of asphalt emulsion to the pavement surface. A pavement that is scarified (milled) requires more tack coat than other surfaces since this process creates more surface area to cover. Rates of application and other requirements for tack coats are given in the contract documents. Tack quantities provided daily by the contractor should be compared with the area covered to verify the rate of application.

### **Uniform Tack Coat Application**

Proper tack coat application goes beyond simply applying the proper quantity of tack. The uniformity of the tack coat application also plays an important role and should not be overlooked.

The tack coat material, which is normally asphalt emulsion, should be uniformly heated to the proper temperature so that it may be sprayed from properly functioning nozzles and not come out in strings. Also, additional dilution may be necessary to achieve the uniform, overlapping fan-shaped spray desired from the nozzles.

### **Breaking of Tack Coat**

Tack coat must “break” (cure) before it is covered with hot mix asphalt, to ensure bonding between pavement layers. As water evaporates from the asphalt emulsion, the tack coat becomes “tacky” and changes from a brown color to black. The rate of evaporation will vary depending on the type and grade of emulsion used, the application rate, the temperature of the existing pavement surface, and other environmental conditions. The pavement surface must be completely





clean and free of moisture before the tack coat is applied. Tack coats shall not be applied when the temperature on the base being covered is less than 25 degrees F.

### **Flushing or Bleeding**

Flushing or bleeding is the upward movement of asphalt binder in the hot mix asphalt pavement resulting in the formation of a film of asphalt binder on the surface. The most common cause is too much asphalt binder in one or more of the pavement courses, resulting from too rich a plant mix, an improperly constructed seal coat, too heavy a tack coat, or solvent (such as diesel fuel) carrying asphalt binder to the surface. It may also occur when a new mat is released to traffic before it has sufficiently cooled, or by over-compacting during rolling operations. Some possible solutions to these situations include reducing the asphalt binder content, checking the plant calibration, reducing the tack rate, prohibiting the use of solvents, allowing the mat to cool longer before opening to traffic, and finally, establishing and maintaining a consistent rolling pattern.



### **Tender Mixes**

#### **High Temperature Tenderness**

Some HMA mixes exhibit tenderness (low mix viscosity) at high temperatures, typically seen as pushing and shoving under the initial breakdown rollers. Likely causes for high temperature tenderness include excess sand or excess asphalt binder in the mix.



## Chapter 9

---

An incorrect binder grade can also contribute to the tenderness problem.

A simple solution to this problem is to delay initial breakdown rolling, allowing the mix viscosity to increase to the point of supporting the rollers. The danger in delaying rolling is failure to obtain required density, due to the cooler mat temperatures. Binder and aggregate changes may also be needed to overcome mix tenderness occurring at or near placement temperatures.

### Mid-Range Tenderness

On some Superpave designed mixtures, a tender zone has been identified in temperature ranges of approximately 200-240 degrees F. The mixture can be satisfactorily compacted above this range or below this range, but the mixture tends to push and shove under steel-wheeled rollers within the temperature range. Rolling with a steel roller within the tender zone may actually cause decompaction and will likely damage the mat. If used carefully, a pneumatic roller may be utilized to compact within this tender range but may have mix pick-up problems when modified asphalt binders are used. Pneumatic rollers can also introduce tire marks in the mat that may be difficult to remove later with the finish roller.

When a mixture is being produced that is found to be tender, the preferred compaction method is to obtain density prior to cooling into the tender zone. It is important to get the breakdown roller(s) close behind the paving machine in order to obtain as much compaction as possible before the mat cools into the tender zone temperature range.



## Chapter 9

---

This may require additional rollers or, in some cases, the mixture temperature may be increased slightly to provide more compaction time. Once the mat has cooled below the tender zone, a steel-wheeled roller may be used to finish compaction and remove marks.

### **Mix Pickup**

Mix pickup, particularly by pneumatic (rubber-tired) rollers, has always been a concern when compacting HMA mixes. The problem has been magnified in recent years with the increasing use of polymer-modified binders. Polymer-modified binders tend to be more “sticky” than conventional binders, requiring additional diligence on the part of the contractor during compaction operations.

When the binder sticks to the roller, fines are pulled from the surface of the mat. This creates an open texture on the mat surface, which in extreme cases can lead to similar consequences as mix segregation. The fines accumulate on the tires until they slough off, forming “patties” on the surface of the pavement. Though very undesirable from roughness and cosmetic standpoints, the patties themselves are not usually detrimental to pavement performance. If possible, remove the loose patties from the pavement surface before performing additional rolling.

The best technique to minimize mix pickup is to keep roller tires hot, as close to mix temperature as possible. The roller tires (and drums) should be kept clean, to prevent mix from accumulating.



## Chapter 9

---

To do so, the roller's spray bars, mats, and scrapers should be in place and properly functioning. Use of approved release agents in the roller's water system may also help prevent mix from sticking to tires and drums.

### Roller Marks

There are a variety of causes for roller marks in a finished HMA surface. Mix tenderness, mentioned previously, may result in roller tire indentations that are unable to be removed by subsequent rolling. Excessive tire pressures or roller weights, along with improper rolling techniques, can also contribute to the problem.

As mentioned previously in this chapter, rolling a very tender mix should be avoided if possible. Contractors should properly maintain their equipment (tire pressures, ballast, etc.) and operate rollers at appropriate speeds, avoiding abrupt turns and stopping on hot mat, while maintaining consistent rolling patterns. Workmanship and attention to details are keys to a good looking mat.

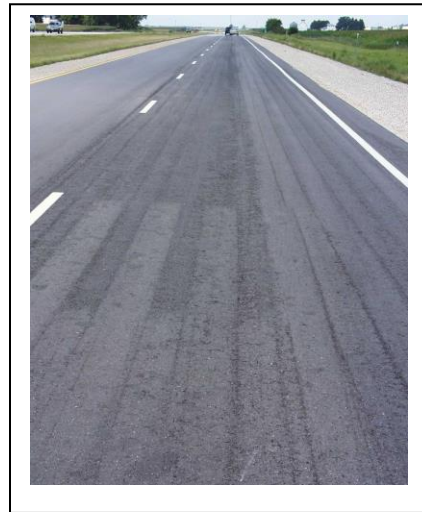

### Wavy Surface

There are a wide variety of sources that may cause the pavement to have a wavy surface. It all starts with the mix coming from the plant. Temperature fluctuations in the mat are a problem and can lead to waves due to non-uniform compaction. Also, excessive speed or incorrect impact frequency of a vibratory roller may result in corrugations or “washboarding” effect on the pavement surface.

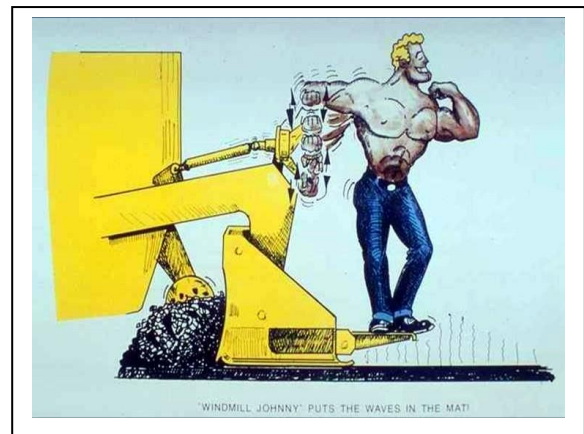

Another possible cause is drivers improperly setting or holding the brakes on delivery trucks. This impedes the forward motion of the paver, thereby reducing paving speed and increasing mat depth in localized areas. The paver itself can create waves as well. In addition to paver speed, fluctuating hopper level and the paver's feeder screws and grade control devices can all contribute to making waves. Work with the Contractor to determine the cause and the adjustments or changes in operation necessary to eliminate the problem.



### **Reflective Bumps**

Reflective bumps typically occur on the first lift of HMA resurfacing over filled pavement joints. This results in a lack of smoothness and may lead to cracking and further deterioration of the pavement. It is believed that the heat from the overlay draws the joint filler / sealant to the surface, where it creates a bubble under the HMA lift. Steel rollers often accentuate the bump as they roll across the joint location.

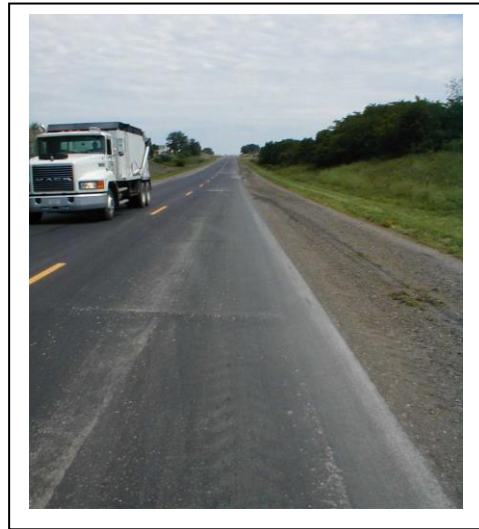

To minimize the potential for reflective bumps, it is important that all loose or excess joint material be removed prior to overlay. It is also recommended to keep Maintenance forces aware of upcoming resurfacing projects so that crack filling or joint sealing is not done in the months just prior to the resurfacing.

During construction, make sure to use the proper tack coat application rate and consistency. If reflective bumps are encountered, breakdown with a pneumatic roller and/or delaying or

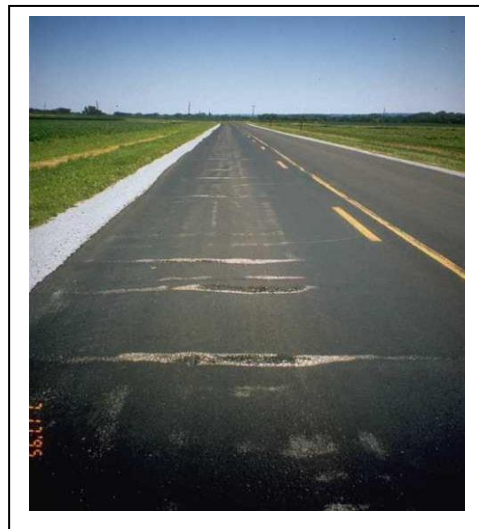

eliminating the steel finish roller may help minimize the effect. If the project involves multiple lifts of resurfacing, good results have been obtained by “tight blading” (shaving off) the bumps prior to placing upper HMA lifts.

### **Cracking**

There are several different types of cracking that can occur in a HMA pavement surface. Cracking may occur immediately in a newly placed mat or may show up at a later time. Over-rolling can be a prime cause of cracking in a newly placed mat. Watch for over-rolling, particularly at transverse headers or when the contractor is trying to roll out a bump. Following are discussions of some of the more common types of cracking in HMA pavements, which may occur at time of construction (checking) or at some point later in the life of the pavement (low temperature or fatigue).

#### **Checking**

Checking is defined as short transverse cracks that typically do not extend completely through the course but are approximately ½ inch in depth. Checking is primarily due to mix deficiencies resulting in a tender mix but may also be caused by excessive deflection in pavement structure under the compaction equipment. To a lesser extent, overheated mix can contribute to checking as well. The long-term solution is to change mix properties. In the short-term, the amount of checking can be reduced by changing the rolling zone and type of rollers used to compact the mix.



## Chapter 9

---

Low temperature, fatigue, and reflection cracking are other types of cracking that may develop later in the life of hot mix asphalt pavements.

### **Low Temperature (Thermal) Cracking**

Low temperature cracking is largely an environmental distress, due to stresses and strains induced by temperature change. This distress shows up as transverse cracks in full depth pavement, spaced from 20 to 100 feet apart. Low temperature cracking is not traffic or aggregate related; the asphalt binder in the mix largely influences it.

Low temperature cracking may be prevented or minimized by:

- Using a less stiff (softer) asphalt binder.
- Using an asphalt binder less prone to aging (based on experience & testing results).
- Constructing hot mix asphalt with proper air voids.

### **Fatigue Cracking**

Fatigue cracking first exhibits itself as distress in wheel paths. It results in progressive damage, such as longitudinal cracking, alligator cracking, or potholes. Fatigue cracking is affected by a number of factors, including asphalt binder, aggregates, pavement structure, or failure of the subgrade.

Fatigue cracking may be prevented or minimized by:

- Designing for actual number of heavy loads.
- Keeping subgrade dry (low deflections).
- Using thicker pavements.
- Using resilient paving materials.

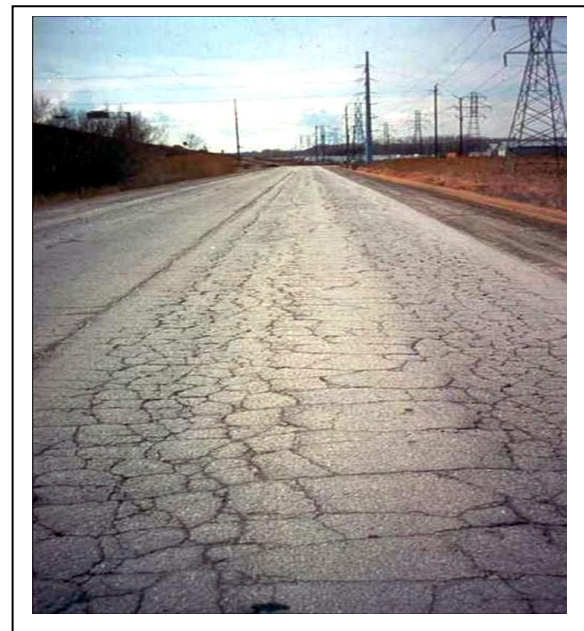

## Chapter 9

---

- Using materials that are not moisture sensitive.

### **Reflection Cracking**

Reflection cracking occurs in HMA overlays over cracked or jointed pavements. The cracks in the overlays reflect the crack pattern in the pavement structure underneath. They are caused by vertical or horizontal movements in the pavement beneath the overlay and brought on by expansion and contraction with temperature or moisture change.



While little can be done to completely prevent this problem, there are treatments available that have varying degrees of success in delaying the onset of reflection cracking. Most of these treatments involve placement of fabric, membrane, or another elastic interlayer between the existing pavement and the HMA overlay.

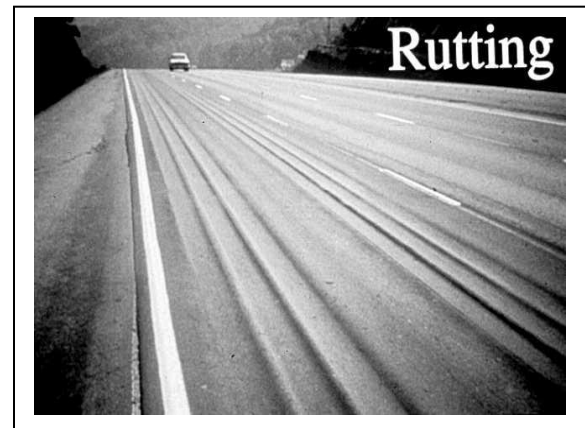

### **Rutting**

Pavement rutting is a permanent deformation, typically seen in the vehicle wheel paths. Rutting usually occurs during periods of high temperature extremes, combined with heavy vehicle axle loads on the affected pavement. Rutting may occur in the subgrade or subbase, due to a weak subgrade or underlying layer, or in the hot mix asphalt itself. If properly designed and constructed, gyratory (Superpave) mixes should not experience rutting.



Rutting may be prevented or minimized by:

- Specifying the appropriate asphalt binder grade.



## Chapter 9

- Not using too much asphalt binder (stay below the maximum film thickness).
- Using cubical, crushed aggregate.
- Providing good aggregate gradation (skeleton).
- Achieving proper compaction.

### **Crushing Aggregate**

Aggregate crushing may be seen as white spots on the surface after rolling. This is often a result of rolling a cold mat or using a vibratory breakdown roller that is too heavy or operating at excessive amplitude. Softer aggregates are obviously more prone to crushing than harder, more durable material. Aggregate crushing was more common on projects using early coarse Superpave mixes, which typically had more stone-on-stone contact than more recent mixes.

Current mix requirements have reduced the problem to some extent, by providing more room within the mix for aggregate to be reoriented during the compaction process. As a rule of thumb, the compacted lift thickness should be 3 to 4 times the nominal maximum aggregate size in the mix.

The breakdown rolling needs to take place at a high enough mat temperature so that the asphalt binder's viscosity remains low enough to lubricate (rather than bind) the aggregate. During compaction, this helps the particles slide past each other and reorient themselves into a more dense configuration.



In addition, vibratory breakdown rollers should use low amplitude and high frequency settings to “massage” (rather than “hammer”) the mix into place.

### **Longitudinal (Centerline) Joints**

Pavements with high quality longitudinal (centerline) joints will last longer and require less maintenance than those with poorly constructed joints. As discussed in a previous chapter, there are certain procedures to follow in order to obtain a tight, well-matched centerline joint. These concepts are worthy of repeating here.



#### **First Lane Placement**

- Use a string line to maintain true edge alignment at longitudinal joint locations. The string line should be secured with extra nails in curves to minimize the “chord” effect, thereby facilitating a better joint match by the second lane.
- Provide enough mix at the end of the screed by maintaining a consistent head of mix along the length of the paver augers. Mix confinement by end gate will result in uniform edge to match.
- The vertical face of the exposed longitudinal joint (cold mat) must be tack coated as a separate operation before placing the adjacent lane. This insures a good seal at the joint. Do not allow tack to be sprayed on the surface of the lane being matched.



#### **Second Lane Placement**

- Allow 1/2 to 1-1/2 inches of overlap at the joint, with 1-inch being preferred. Too much lap at

centerline will result in a wide scab of mixture at the surface or the appearance of a white streak at the joint, caused by the roller crushing aggregate in the mix against the surface of the cold mat.

- Allow enough loose lift thickness to compensate for roll down so that no bump or dip is produced at the joint (20 to 25 percent reduction in thickness is typical). If loose lift thickness is insufficient prior to rolling, the joint will appear smooth but lack density.
- Keep the end plate of the paver tight against the screed and tight against the surface of the cold mat. Do not allow mix to run out between the edge of screed and end plate, or in front of the end plate.
- Minimize the amount of handwork used in constructing longitudinal joints. This includes raking, luting, and “bumping” the joint. If excess mix is placed at the joint location, the extra material should be pulled back and removed, rather than “broadcast” across the mat’s surface. Once adjusted, the paver will do a better job of uniformly placing the mix than by using hand tools.
- Compact the joint from the hot side of the joint, not the cold side. This allows thru traffic to use the adjacent lane and also prevents damage to the cold mat by vibratory (breakdown) rollers. Never have the vibrators turned on when the breakdown roller is being supported mainly on the cold side of the joint.

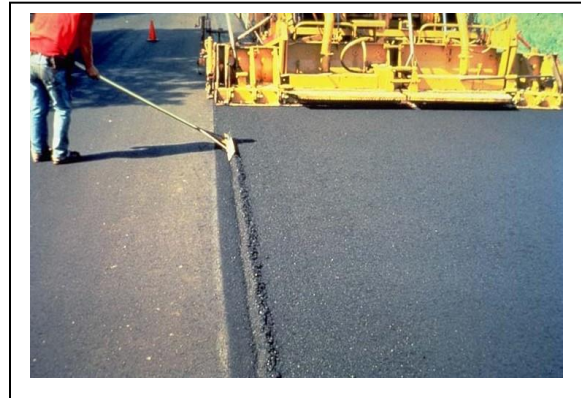

## Chapter 9

### Notched Wedge Longitudinal Joint

The Notched Wedge Joint has been used successfully to overcome density and resulting cracking and raveling problems often associated with conventional butt joint construction. This alternative has been shown to increase the in-place density at the longitudinal joint, resulting in a tighter, longer lasting joint.

As its name suggests, the configuration (cross-section) of the Notched Wedge Joint consists of “notch” and “wedge” portions.

#### Notch

- Located at the top of the lift.
- Defines the joint location.
- Provides a vertical edge for matching and compacting the second side against.
- Compacted notch depth is approximately  $\frac{1}{4}$ " more than the nominal maximum aggregate (mix) size, but no more than half the intended lift thickness. Loose notch depth must account for roll-down of the mat during compaction.

#### Wedge

- Sloping portion of the joint, diagonally from the bottom of the notch.
- Slope of the wedge may vary, but is typically 12:1.
- Width of the wedge is typically 12", but may vary with the lift thickness.
- Vertical step at the toe of the wedge is acceptable (and usually preferred).

The Notched Wedge Joint (NWJ) is formed by an attachment to the end of the paver screed, which extrudes the shaped edge of the first side (lane)

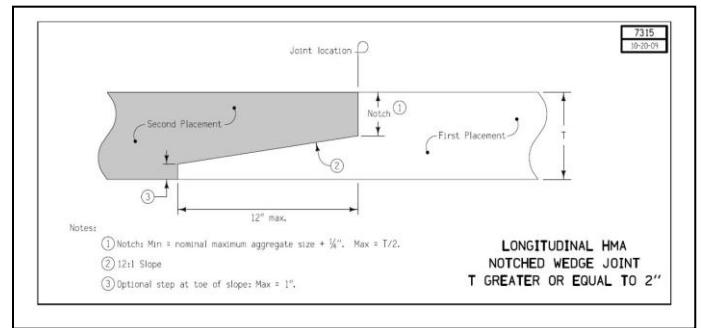

## Chapter 9

---

placed. Adjustments can be made to vary the notch depth and wedge slope. A small trailing roller acts to “set” the wedge, while providing some compaction. Conventional methods are used for compaction of the mat itself, and for placing and compacting the second side of the joint (lane) to match.

Details of the NWJ may be included in the contract documents for the project. If the NWJ is not specified for the project and the contractor requests approval to use it, contact your supervisor and/or the Office of Construction to determine if its use is appropriate for the situation.



### **Screed Marks / Mat Texture**

There are a number of different issues that may contribute to the appearance of screed marks and variations in mat texture behind the paver. Some of these mat defects may be purely cosmetic in nature, while others could result in poor pavement characteristics or performance.



### **Screed Settling**

Screed settling usually occurs when the paver is stopped for lengthy periods of time. Delays may be caused by paver or plant-related breakdowns, or due to a lack of timely arrivals of mix delivery trucks. Another source of screed settling occurs whenever a delivery truck backs into and bumps the paver, causing the screed to drop. The resulting dip in the mat may be difficult to remove, sometimes becoming even more pronounced by the efforts to roll it out.



## Chapter 9

### Cold Screed

A paver's screed should be heated before paving proceeds. Generally, the screed heaters may then be turned off after paving is underway, as the mix then keeps the screed hot. If the screed is too cold, mix will not readily flow under the screed, with larger aggregate catching and dragging under the screed plate. The resulting pavement surface appears coarse and open-textured, similar to a segregated mix.



### Screed Crown

If there is an open or torn texture at the center of the mat behind the paver, additional lead crown may be needed in the front edge of the screed. This forces more mix into the central portion of the screed, closing the texture. If the tears occur on the outer edge, there may be too much crown in the leading edge, forcing too much material in the center and too little at the edges. Reducing the center crown slightly will distribute more material toward the edges and provide a more uniform mat.

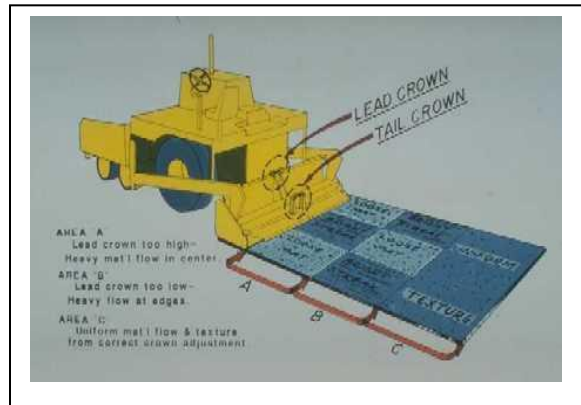

### Mat Problem Trouble-Shooting

Many potential problems and possible solutions regarding hot mix asphalt paving are included in the Mat Problem Trouble-Shooting Guide, found in the Appendix (Chapter 10).

Problem	Causes											
	1. Poor Mix Compaction	2. Poor Mix Design	3. Poor Mix Temperature	4. Poor Mix Placement	5. Poor Mix Spreading	6. Poor Mix Compaction	7. Poor Mix Compaction	8. Poor Mix Compaction	9. Poor Mix Compaction	10. Poor Mix Compaction	11. Poor Mix Compaction	12. Poor Mix Compaction
Wavy Surface - Short Waves (Ripples)	✓	✓	✓	✓	✓	✓	✓	✓	✓	✓	✓	✓
Wavy Surface - Long Waves	✓	✓	✓	✓	✓	✓	✓	✓	✓	✓	✓	✓
Tearing of Mat - Full Width	✓	✓	✓	✓	✓	✓	✓	✓	✓	✓	✓	✓
Tearing of Mat - Center Streak	✓	✓	✓	✓	✓	✓	✓	✓	✓	✓	✓	✓
Tearing of Mat - Outside Streaks	✓	✓	✓	✓	✓	✓	✓	✓	✓	✓	✓	✓
Mat Texture - Nonuniform	✓	✓	✓	✓	✓	✓	✓	✓	✓	✓	✓	✓
Screed Marks	✓	✓	✓	✓	✓	✓	✓	✓	✓	✓	✓	✓
Screed Not Responding to Correction	✓	✓	✓	✓	✓	✓	✓	✓	✓	✓	✓	✓
Auger Shadows	✓	✓	✓	✓	✓	✓	✓	✓	✓	✓	✓	✓
Poor Precompaction	✓	✓	✓	✓	✓	✓	✓	✓	✓	✓	✓	✓
Poor Longitudinal Joint	✓	✓	✓	✓	✓	✓	✓	✓	✓	✓	✓	✓
Poor Transverse Joint	✓	✓	✓	✓	✓	✓	✓	✓	✓	✓	✓	✓
Transverse Cracking (Checking)	✓	✓	✓	✓	✓	✓	✓	✓	✓	✓	✓	✓
Mat Shoving Under Roller	✓	✓	✓	✓	✓	✓	✓	✓	✓	✓	✓	✓
Roller Marks	✓	✓	✓	✓	✓	✓	✓	✓	✓	✓	✓	✓
Poor Mix Compaction	✓	✓	✓	✓	✓	✓	✓	✓	✓	✓	✓	✓

**Procedure for Using Table**  
 1. Find problem above.  
 2. Checks indicate causes related to the paver.  
 3. X's indicate other problems to be investigated.

**NOTE:** Many times a problem can be caused by more than one item. Therefore, it is important that each cause listed be eliminated to assure solving the problem.

# **APPENDIX**

## X. Appendix

### **Superpave (Gyratory Mix Design) Discussion**

In 1987, the Strategic Highway Research Program (SHRP) began developing a new system for specifying asphaltic materials. The final product of the SHRP asphalt research program is a new system called Superpave, which is short for Superior Performing Asphalt Pavements. Superpave represents an improved system for specifying asphalt binders and mineral aggregates, developing HMA mixture design, and analyzing and establishing pavement performance prediction. The system was developed to provide the tools necessary to design HMA mixes that will perform better under heavy traffic and extreme temperatures. The goal is to provide pavements that are resistant to rutting, fatigue cracking, and low temperature cracking. The Superpave asphalt binder specification and mix design system include various test equipment, test methods, and criteria.

The unique feature of Superpave system is that it is a performance-based specification system. The tests and analyses have direct relationships to field performance. The Superpave asphalt binder tests measure physical properties that can be related directly to field performance by engineering principles.

Superpave mixes tend to be more coarse than conventional mixes. The coarse-graded Superpave designed mixtures with high coarse aggregate content do typically act differently than the fine-graded mixtures, and this must be considered during compaction. Coarse-graded mixtures often tend to cool more quickly, resulting in less time available for rolling. This may require that additional rollers be provided, and closer attention be paid to pavement compaction temperature.

It is important that the personnel working at the laydown site communicate with the plant personnel. If the mixture is acting differently underneath the rollers, then something may have changed at the plant. One of the most common changes in the plant-produced mixture is moisture content. A change in moisture content will have a significant effect on the handling and compaction characteristics of a Hot Mix Asphalt (HMA) mixture. Sometimes very small changes at the plant can cause significant changes during compaction. So, if the mixture appears to be acting differently, call the plant and see if something has changed.

The contractor must understand mixtures and their relationship to compaction. This understanding can be gained with experience, but only if one learns from the past mistakes and from procedures that have been successful.



Equipment should be selected specifically for a project. Different mixtures require different compaction techniques. A set of rollers and a rolling pattern that worked on one project may not be satisfactory for another project. This can be evaluated during construction of a test strip.

Rollers should generally stay close behind the paver. If the mix begins to shove when rolled, additional rolling with steel-wheel rollers will likely be detrimental. The shoving mixture can usually be rolled with a rubber-tire roller without detrimental movement. When modifiers are used in a mixture, rubber-tire rollers may tend to pick up the asphalt and thus may have to be removed from the project.

If the contact pressure is too low, it may be difficult or impossible to meet density requirements. The contact pressure can be increased in steel-wheel rollers by increasing the weight of the roller. The contact pressure can be increased in rubber-tired rollers by increasing the tire pressure and/or increasing the weight.

On some Superpave designed mixtures, a tender zone has been identified in temperature ranges of approximately 200-240 F. The mixture can be satisfactorily compacted above this range or below this range, but the mixture is tender within the temperature range and cannot be adequately compacted. This is not true for all mixtures, but it has been observed for some Superpave designed mixtures. The mix can often be satisfactorily rolled with rubber-tire rollers within this tender range but may experience pick-up problems when modifier binders are used.

When a mixture is being produced that is tender within the mid-temperature range, the preferred compaction method is to obtain density prior to cooling to the tender zone. This may require additional rollers, or in some cases, the mixture temperature may be increased slightly to provide more compaction time.

It has been suggested that tenderness at mid-range temperatures may be due to incomplete drying of the aggregate in the mix. Moisture trapped in the cracks and fissures of the stone is ultimately released by manipulation of the mix, causing the mix to become more fluid (tender). While this theory has not been conclusively proven, it does suggest that close attention be paid to the aggregate drying process. In addition, use of proper stockpiling and aggregate handling procedures will help minimize the potential for excess moisture in the mix.

### **Hot Mix Asphalt (HMA) Paving In Iowa – A Brief History**

Historically, the state was the designer and inspector of hot mix asphalt mixes. The contractor's role back then was simple: to use a recipe given to them by the state, mix the materials in their plant and place it on the roadway. The Department of Transportation would do inspection and take samples of the mix for laboratory testing. The next day, or several days later, the results of the lab testing would indicate whether the mix met contract specifications. At that point in time, the roadway was already in place, leaving perhaps miles of deficient work.

#### **Quality Management Asphalt (QMA):**

During the 1980's and 1990's the construction industry and the Iowa Department of Transportation worked together to improve the quality of the HMA and the methods by which project testing was accomplished. In 1992, the Quality Management - Asphalt (QMA) program was implemented on all projects over 5000 tons. Quality Management changed the way that HMA pavements were designed and placed. Components of QMA are still in place today.

Under QMA, the contractor's personnel develop the mix design using aggregate that keeps them competitive (often local sources), and creating a mix they believe will be economical and long lasting. The mix design is then submitted to the DOT for acceptance. During construction, the contractor's personnel are responsible for process (quality) control testing (with random samples done several times daily). If something unusual is occurring to the mix, it can be monitored instantly, and changes can be made to ensure that poor quality mix does not get to the roadway. The morning test results are available to the quality control technician within hours of starting up the plant, giving the contractor information right away to affect the quality of mix being produced. Under this agreement, the contractor retains controls of their product and process. The contractor does random sampling on their materials and tests them multiple times each day. The agency receives split samples of the materials and tests them on a less frequent basis to verify the contractor's work. Verification is done by comparing the contractor's test results to the agency's test results (on the same sample) and assuring that it correlates. This quality assurance is an important check on the contractor's work. QMA looks at individual test results to determine if they are in specification, and sometimes looks at running average's (an average of the last 4 tests) to determine if the trend in the test data is good.

Under the old QMA system (1992-2010), contractors could incur penalties if their mix was not up to specification but could not earn incentive pay for laboratory test results that were very good.

### **Percent Within Limits (PWL):**

Beginning with the October 2010 letting, the Iowa DOT implemented the new *Section 2303* of the *Standard Specifications*. This specification takes the next step beyond QMA and provides incentives to the contractor to produce HMA that is consistently within specification and on target.

To accomplish this, methods were developed to analyze the test data and determine the amount of material that complies with the specifications. The result of the analysis is called the “Percent Within Limits” or PWL. The previous QMA specification did not provide for incentive payments to the contractor for providing a superior quality product, only disincentives for poor quality. The PWL specification provides incentive payments for field voids up to a maximum of 4% and lab voids up to a maximum of 3%. The contractor can earn these bonuses by controlling the production and construction operations to provide a consistent mixture on target – and a mat compaction that is both consistent and thorough. The goal is to “make quality pay” for those contractors that provide the best product.

Both incentive and disincentive are based on equations that provide a more smooth and continuous payment schedule than the stepped price adjustment schedules used in the past. Field voids are analyzed daily, with eight core density values that are obtained each day. Lab voids require grouping of days or lots to obtain a minimum of eight test values before the PWL incentive/disincentive pay factors will be calculated. It is important that a minimum of 8 test results are used, to ensure valid results from the statistical formulas involved in PWL. Less than 8 test results are not sufficient to perform a statistical analysis.

The HMA Plant Report Program and the Quality Control charting Program were modified from the existing QMA version to the new PWL version, to accumulate the needed test data and calculate the pay factors for the mix.

### **Average Absolute Deviation (AAD):**

Average Absolute Deviation (AAD) is a statistical term meaning the average of the “deviation from target”. It’s a statistical average. When there are not 8 test results (as mentioned above) to conduct PWL analysis, an AAD analysis is done instead on mainline paving. This was part of the PWL program initiated in 2010. In 2012, the specification changed so that AAD is the method of analysis for all non-mainline paving, and mainline paving with less than 8 total test results. AAD allows the contractor to be penalized for poor results but does not provide incentive for superior results.

### **In Summary:**

The industry continues to evolve. The test results have not changed much in the last 30 years, but the method of analyzing test data and reporting requirements have changed significantly over the past 10 years. Technicians involved in Hot Mix Asphalt projects need to be familiar with PWL, AAD, control charts, reporting, specification compliance, etc., and the effect that these items will make to the contractor's operations and to contract administration.

*The table on the following pages contains a comparison of Former (non-PWL) to Current (PWL) specification requirements. Its inclusion here is to illustrate both the differences and similarities resulting from the most recent evolution of the specification.*

**Comparison of Former (non-PWL) to Current (PWL) Specifications**

Type	Former (non-PWL) Spec.	Current (PWL) Spec.
General	Contractor QC required for contracts with 5000 tons or more of HMA.	Contractor QC required for bid items with more than 1000 tons of HMA.
General	Class 1A, 1B and 1C compaction requiring 96%, 95% and 94% of lab density ( $G_{mb}$ ) respectively.	Class 1 compaction requiring a minimum of 91.5% of maximum specific gravity ( $G_{mm}$ ) for all mainline paving.
General	Average percent field air voids on cores shall not exceed 8.0%.	No maximum <b>average</b> field air voids. QI and PWL calculated for field voids based on 8.5% maximum and 3.5% minimum field voids limits.
General	Test strips required for intermediate and surface courses on Interstate highways and surface courses on Primary highways.	Test strips required same as non-PWL, with additional test strips optional for the contractor. 9.0% maximum field voids limit for test strips.
General	Test strips limited to 750 tons for lift thicknesses of 2 inches or less or 1000 tons for lifts greater than 2 inches.	Test strips limited to one half of a day's normal production.
General	No contractor testing plan required.	Contractor testing plan required prior to pre-con as per IM 511, Appendix D.
Sampling	7 cores required per lot.	8 cores required per lot.
Sampling	30 pounds minimum HMA sample.	40 pounds minimum HMA sample.
Sampling	Cold-feed aggregate samples directed and witnessed by the Engineer daily.	Cold-feed aggregate samples directed and witnessed by the Engineer on the first day only.
Sampling	Contractor must obtain samples within 15 minutes of being notified to sample.	Sampling must be initiated within 15 minutes and completed within 30 minutes of being notified to sample.

<b>Type</b>	<b>Former (non-PWL) Spec.</b>	<b>Current (PWL) Spec.</b>												
Sampling	<p>Loose HMA samples for lots of 2000 tons or greater will be obtained from sublots.</p> <p>The first subplot will be 500 tons, with three additional sublots determined by dividing the remainder by three.</p> <p>For lots less than 2000 tons, the first subplot will be 500 tons and the remaining sublots will be 750 tons each.</p>	<p>Equal sublots determined by dividing the estimated tonnage by the number of sublots in following table:</p> <table border="1" data-bbox="1076 401 1391 781"> <thead> <tr> <th>Estimated Tons (Mg)</th> <th>No. of Sublots</th> </tr> </thead> <tbody> <tr> <td>101-500</td> <td>1</td> </tr> <tr> <td>501-1250</td> <td>2</td> </tr> <tr> <td>1251-2000</td> <td>3</td> </tr> <tr> <td>2001-4500</td> <td>4</td> </tr> <tr> <td>Over 4500</td> <td>5</td> </tr> </tbody> </table>	Estimated Tons (Mg)	No. of Sublots	101-500	1	501-1250	2	1251-2000	3	2001-4500	4	Over 4500	5
Estimated Tons (Mg)	No. of Sublots													
101-500	1													
501-1250	2													
1251-2000	3													
2001-4500	4													
Over 4500	5													
Testing	Lab voids ( $P_a$ ) shall be maintained within a tolerance of -0.5 to +1.0 from the target value.	Tolerances for lab voids ( $P_a$ ) are $\pm 1.0\%$ from the target value.												
Testing	Moving average of four tests used for lab voids acceptance. Shut-down required if moving average is outside the tolerances.	Weekly lots of lab voids used to calculate PWL if 8 tests or more are run. Weeks may be grouped to obtain 8 tests. AAD calculated for bid items with less than 8 lab voids tests. No shut-down required.												
Testing	Validation of contractor's cold-feed gradation by the District Lab is performed on split samples.	Validation of contractor's cold-feed gradation by the District Lab is performed by comparing the contractor's results to an ignition oven gradation.												
Testing	No gradation correction factors required.	Correction factors determined on first day of production by comparing DOT gradation test results on a cold-feed sample to DOT gradation results on an ignition oven sample.												
Payment	If lot average gradation is outside tolerances, price adjustment schedule is applied.	No price adjustment for gradation. Target change or JMF adjustment required if gradation is outside tolerances.												

## Chapter 10

---

Type	Former (non-PWL) Spec.	Current (PWL) Spec.
Payment	If filler/bitumen ratio is outside the tolerances, price adjustment schedule is applied.	No price adjustment for filler/bitumen ratio. If filler/bitumen ratio is outside the tolerances, contractor must adjust to start production the next day.
Payment	If QI for field density cores is less than 0.00, 75% maximum pay or the Engineer may declare the lot or parts of the lot defective.	If PWL for field voids is less than 50%, 75% maximum pay or the Engineer may declare the lot or parts of the lot deficient or unacceptable.
Payment	Outliers for cores removed if 1.80 standard deviations or greater from the mean.	Outliers for cores removed if 1.80 standard deviations or greater from the mean (same as non-PWL).
Payment	No incentive paid for field density. Price adjustments based on 4-step QI pay schedule.	Incentive paid for field voids PWL greater than 95%, up to a maximum of 4%. Price adjustments based on equations.
Payment	No price adjustments or incentive paid for lab voids.	Incentive paid for lab voids PWL greater than 95%, up to a maximum of 3%. Price adjustments based on equations. If fewer than 8 lab voids results are available for a bid item, price adjustments based on AAD schedule with no incentive pay.
Payment	If the percent of asphalt binder in the mix is outside the tolerances, price adjustment schedule is applied.	No price adjustment for binder content. Contractor may adjust binder content as needed to achieve a uniform mix.
Payment	Test strips paid for same as rest of mix.	Special pay schedules for test strips.

**Factors Influencing Compaction**

Item	Effect	Corrections*
<b><i>Aggregate</i></b>		
Smooth Surfaces	Low interparticle friction	Use light rollers; lower mix temperature
Rough Surfaced	High interparticle friction	Use heavy rollers
Unsound	Breaks under steel-wheeled rollers	Use sound aggregate; use pneumatic rollers
Absorptive	Dries mix – difficult to compact	Increase asphalt in mix
<b><i>Asphalt</i></b>		
Viscosity		
– High	Particle movement restricted	Use heavy rollers; increase temperature
– Low	Particles move easily during compaction	Use light rollers; decrease temperature
Quantity		
– High	Unstable & plastic under roller	Decrease asphalt in mix
– Low	Reduced lubrication – difficult compaction	Increase asphalt in mix; use heavy rollers
<b><i>Mix</i></b>		
Excess Coarse Aggregate	Harsh mix – difficult to compact	Reduce coarse aggregate; use heavy rollers
Oversanded	Too workable – difficult to compact	Reduce sand in mix; use light rollers
Too Much Filler	Stiffens mix – difficult to compact	Reduce filler in mix; use heavy rollers
Too Little Filler	Low cohesion – mix may come apart	Increase filler in mix
<b><i>Mix Temperature</i></b>		
High	Difficult to compact – mix lacks cohesion	Decrease mixing temperature
Low	Difficult to compact – mix too stiff	Increase mixing temperature
<b><i>Course Thickness</i></b>		
Thick Lifts	Hold heat – more time to compact	Roll normally
Thin Lifts	Lose heat – less time to compact	Roll before mix cools; increase mix temperature
<b><i>Weather Conditions</i></b>		
Low Air Temperature	Cools mix rapidly	Roll before mix cools
Low Surface Temperature	Cools mix rapidly	Increase mix temperature
Wind	Cools mix – crusts surface	Increase lift thickness

\* Corrections may be made on a trial basis at the plant or job site. Additional remedies may be derived from changes in mix design.





### **Asphalt Terminology (Glossary)**

#### **Absorption**

The property of an aggregate particle to take in and hold a fluid. For our purposes, usually asphalt binder or water.

#### **Aggregate**

Any hard, inert, mineral material used for mixing in graduated fragments. It includes sand, gravel, crushed stone, and slag.

#### **Aggregate Storage Bins**

Bins that store the necessary aggregate sizes and feed them to the dryer in substantially the same proportions as are required in the finished mix.

#### **Air Voids**

Internal spaces in a compacted mix surrounded by asphalt-coated particles, expressed as a percentage by volume of the total compacted mix.

#### **Alligator Cracks**

Interconnected cracks forming a series of small blocks resembling an alligator's skin, caused by excessive deflection of the surface over unstable subgrade or lower courses of the pavement.

#### **Asphalt Binder**

A dark brown to black cementitious material, which occurs in nature or is obtained in petroleum processing. Asphalt binder is classified according to the *Standard Specification for Performance Graded Asphalt Binder, AASHTO Designation MP1*. It is also commonly referred to as Asphalt Cement.

#### **Asphalt Binder Content**

A measurement (by weight) of the asphalt binder in the mix, usually expressed as a percentage.

**Asphalt Cement** – See **Asphalt Binder**

**Asphalt Cement Concrete** – See **Hot Mix Asphalt**

#### **Asphalt Distributor**

A truck or a trailer having an insulated tank, heating system and distribution system. The distributor applies asphalt to a surface at a uniform rate.

#### **Asphalt Emulsion**

An emulsion of asphalt binder and water that contains a small amount of an emulsifying agent. Emulsified asphalt droplets may be of either the anionic (negative charge), cationic (positive charge), or nonionic (neutral).

### **Asphalt Joint Sealer**

An asphalt product used for sealing cracks and joints in pavements and other structures.

### **Asphalt (Flexible) Pavements**

Pavements consisting of a surface course of asphalt concrete over supporting courses such as asphalt concrete bases, crushed stone, slag, gravel, Portland Cement Concrete (PCC), brick, or block pavement.

### **Asphalt Primer**

Low viscosity asphalt (highly liquid) that penetrates into a non-bituminous surface upon application.

### **Average Absolute Deviation (AAD)**

The absolute value of the difference of a test result from a specified value, averaged for a specified set of values.

### **Base Course**

Lift(s) of HMA pavement placed on the subgrade or subbase on which successive layers are placed.

### **Batch Plant**

This type of HMA production plant is used to produce individual batches of mix by making use of a pugmill (see *IM 508* for additional information).

### **Binder Course – See Intermediate Course**

### **Bitumen – See Asphalt Binder**

### **Bleeding or Flushing Asphalt**

The upward migration of asphalt binder in an asphalt pavement, resulting in the formation of asphalt film on the surface.

### **Blow-Up**

The localized buckling or upward movement of a PCC pavement caused primarily by excessive expansion.

### **Break and Seat**

A fractured slab technique used in the rehabilitation of Reinforced Concrete Pavement (RCP) that minimizes slab action by fracturing the PCC layer into smaller segments. This reduction in slab length (and debonding from the reinforcement steel) minimizes reflective cracking in new HMA overlays.

### **Breaking**

The phenomenon when asphalt and water separate in an asphalt emulsion beginning the curing process. The rate of breaking is controlled primarily by the emulsifying agent, and somewhat dependent on environmental conditions.

### **Certified Plant Inspection (CPI)**

A specified method of quality control using a Certified Plant Inspector (see *Section 2521* of the *Standard Specifications* for additional information).

### **Coarse Aggregate**

The aggregate particles retained on the #4 (4.75 mm) sieve.

### **Coarse-Graded Aggregate**

A blend of aggregate particles having a continuous grading in sizes of particles from coarse through fine with a predominance of coarse sizes. A gradation below the maximum density line.

### **Cohesion**

Bonding of aggregates by asphalt binder in HMA, increasing stability of the mixture.

### **Cold-Feed Gradation**

The aggregate proportioning system employing calibrated bins to deliver aggregate to the dryer (see *IM 508* for additional information).

### **Cold In-Place Recycling (CIR)**

A method of rehabilitating the HMA surface by milling, adding a stabilizing agent, relaying and compacting in a continuous operation (see *IM 504* for additional information).

### **Cold In-Place Recycling Train**

A unit consisting of a large milling machine towing a screening/crushing plant and pugmill mixer for the addition of rejuvenating agent and production of cold mix base.

### **Compaction**

The act of compressing a given volume of material into a smaller volume.

### **Consensus Properties**

Aggregate characteristics that must follow certain criteria to satisfy a Superpave mix design. Specified test values for these properties are not source specific but widely agreed upon. They include Coarse Aggregate Angularity, Fine Aggregate Angularity, Flat or Elongated Particles, and Clay Content.

### **Consistency (Asphalt Binder)**

The degree of fluidity of asphalt binder (cement) at any particular temperature. The consistency of asphalt binder varies with its temperature; therefore, it is necessary to use a common or standard temperature when comparing the consistency of one asphalt binder with another.

### **Corrugations (Washboarding) and Shoving**

A type of pavement distortion, typically occurring on HMA layers that lack stability. Corrugation is a form of plastic deformation typified by ripples across the pavement surface. These distortions usually occur at points where traffic starts and stops, on hills where vehicles brake on the downgrade, on sharp curves, or where bumps cause vehicles to bounce up and down.

### **Crack**

An approximately vertical random cleavage of the pavement caused by traffic loading, thermal stresses and/or aging of the binder.

### **Crack and Seat**

A fractured slab technique used in the rehabilitation of PCC pavements, that minimizes slab action in a jointed concrete pavement by fracturing the PCC layer into smaller segments. This reduction in slab length minimizes reflective cracking in HMA overlays.

### **Crack-Relief Layer**

An open-graded asphalt mixture placed over a distressed pavement that minimizes reflective cracking by absorbing the energy produced by movement in the underlying pavement.

### **Curing**

The development of the mechanical properties of the asphalt binder. This occurs after the emulsion has broken and the emulsion particles coalesce and bond to the aggregate.

### **Cutback Asphalt**

Liquid asphalt composed of asphalt binder and a petroleum solvent. Cutback asphalts have three types (Rapid Curing (RC), Medium Curing (MC), and Slow Curing (SC)). The petroleum solvent, also called diluents, can have high volatility (RC) to low volatility (SC).

### **Deep Strength Asphalt Pavement**

Pavement containing at least four inches on HMA over non-stabilized base courses.

### **Deflection**

A load-induced, downward movement of a pavement section.

### **Delivery Tolerances**

Permissible variations from the exact desired proportions of aggregate and bituminous material as manufactured by an asphalt plant.

### **Dense-Graded Aggregate**

An aggregate that has a particle size distribution such that when it is compacted, the resulting voids between the aggregate particles, expressed as a percentage of the total space occupied by the material, are less than 10%.

### **Densification**

The act of increasing the density of a mixture during the compaction process.

### **Density**

The unit weight or the weight of a specific volume of mix.

### **Design ESAL**

The total number of equivalent 80-kN (18,000-lb.), single-axle load applications (equivalent single axle loads) expected throughout the design period.

### **Design Lane**

The lane on which the greatest number of equivalent 80-kN (18,000-lb.) single axle loads (ESAL) is expected. This will normally be either lane of a two-lane roadway or the outside lane of a multi-lane highway.

### **Design Period**

The number of years from the initial application of traffic until the first planned major resurfacing or overlay. This term should not be confused with pavement life or analysis period. Adding HMA overlays as required will extend pavement life indefinitely or until geometric considerations (or other factors) make the pavement obsolete.

### **Disintegration**

The breaking up of a pavement into small, loose fragments caused by traffic or weathering.

### **Distortion**

Any change of a pavement surface from its original shape.

### **Drum Mix (Continuous) Plant**

This type of HMA production plant is a continuously operating plant, which mixes the aggregate, asphalt binder and RAP (if used) in the drum (See *IM 508* for additional information).

### **Dryer**

An apparatus that will dry the aggregates and heat them to the specified temperatures.

### **Durability**

The property of an asphalt paving mixture that describes its ability to resist the detrimental effects of air, water and temperature. Included under weathering are changes in the characteristics of asphalt, such as oxidation and volatilization, and changes in the pavement and aggregate due to the action of water, including freezing and thawing.

### **Edge Joint Cracks**

The separation of the joint between the pavement and the shoulder, commonly caused by the alternate wetting and drying beneath the shoulder surface. Other causes are shoulder settlement, mix shrinkage, and trucks straddling the joint.

### **Effective Thickness**

The ratio of the thickness of an existing pavement material compared to the equivalent thickness of a new HMA later.

### **Emulsified Asphalt**

Composed of asphalt binder and water, and a small quantity of emulsifying agent, which is similar to detergent. They may be of either the Anionic, electro-negatively-charged asphalt globules, or Cationic, electro-positively-charged asphalt globules types, depending upon the emulsifying agent. Emulsified asphalt is produced in three grades (Rapid-Setting (RS), Medium-Setting (MS), and Slow-Setting (SS)).

### **Emulsifying Agent or Emulsifier**

The chemical added to the water and asphalt that keeps the asphalt in stable suspension in the water. The emulsifier determines the charge of the emulsion and controls the breaking rate.

### **ESAL (Equivalent Single Axle Loads)**

The effect on pavement performance of any combination of axle loads of varying magnitude equated to the number of 80-kN (18,000-lb.) single-axle loads that are required to produce an equivalent effect.

### **Fault**

A difference in elevation of two slabs at a joint or crack.

### **Fatigue Resistance**

The ability of asphalt pavement to withstand repeated flexing caused by the passage of wheel loads.

### **Field Density**

The density ( $G_{mb}$  (field)) of HMA based on field roller compaction.

### **Field Voids**

The percent by volume of air voids in cores cut from the finished pavement.

### **Fine Aggregate**

Aggregate particles passing the #4 (4.75 mm) sieve.

### **Fine-Graded Aggregate**

A blend of aggregate particles having a continuous grading in sizes of particles from coarse through fine with a predominance of fine sizes. A gradation above the maximum density line.

### **Flexibility**

The ability of an asphalt paving mixture to be able to bend slightly, without cracking, and to conform to gradual settlements and movements of the base and subgrade.

### **Foamed Asphalt**

A combination of high temperature asphalt binder and water to produce foaming.

### **Fog Seal**

A light application of emulsion diluted with water that is applied without mineral aggregate cover.

### **Flux or Flux Oil**

A thick, relatively nonvolatile fraction of petroleum, which may be used to soften asphalt binder to a desired consistency.

### **Fractured Slab Techniques**

Processes used to rehabilitate PCC pavements by eliminating slab action through the reduction of slab size (Crack/Break and Seat) or the pulverization of the PCC slab (Rubblization) into essentially a granular base.

### **Full-Depth<sup>®</sup> Asphalt Pavement**

The term Full-Depth<sup>®</sup> certifies that the pavement is one in which asphalt mixtures are employed for all courses above the prepared subgrade or subbase. A Full-Depth<sup>®</sup> asphalt pavement is laid directly on the prepared subgrade or subbase.

### **Gilsonite**

A form of natural asphalt, hard and brittle, which is mined.



### **Gradation**

The description given to the proportions of aggregate on a series of sieves. Usually defined in terms of the % passing successive sieve sizes.

### **Grade Depressions**

Localized low areas of limited size.

### **Hot Mix Asphalt (HMA)**

Asphalt binder/aggregate mixture produced at a batch or drum-mixing facility that must be spread and compacted while at an elevated temperature. To dry the aggregate and obtain sufficient fluidity of the binder, both must be heated prior to mixing – giving origin to the term “hot mix.”

### **Hot Mix Asphalt (HMA) Overlay**

One or more lifts of HMA constructed on an existing pavement. The overlay may include a leveling course or scarification to correct the contour of the old pavement, followed by uniform course or courses to provide needed thickness.

### **Impermeability**

The resistance an asphalt pavement has to the passage of air and water into or through the pavement.

### **Intermediate Course**

An HMA pavement course between a base course and a surface course.

### **Job Mix Formula (JMF)**

The JMF is the mix design used to begin a HMA project. It is also used as the basis for the control of plant produced mixture. It sets the proportions of the aggregate and amount of asphalt binder.

### **Kinematic Viscosity**

A measure of the viscosity of asphalt, measured in centistokes, conducted at a temperature of 135°C (275°F).

### **Lab Density**

The density ( $G_{mb (lab)}$ ) of HMA based on laboratory compaction.

### **Lab Voids**

The percent by volume of air voids in laboratory compacted specimens.

### **Lane Joint Cracks**

Longitudinal separations along the seam between two paving lanes.

### **Leveling Course**

A course of hot mix asphalt of variable thickness used to eliminate irregularities in the contour of an existing surface prior to placing the subsequent course.

### **Lift**

A layer or course of paving material applied to a base or a previous layer.

### **Lime**

A product used to enhance the bond between aggregate and asphalt binder. It is composed of dust from crushed limestone. Hydrated lime is often specified for surface mixes.

### **Load Equivalency Factor**

The number of 80-kN (18,000-lb.) single-axle load applications (ESAL) contributed by one passage of an axle.

### **Longitudinal Crack**

A vertical crack in the pavement that follows a course approximately parallel to the centerline.

### **Maintenance Mix**

A mixture of asphalt emulsion and mineral aggregate for use in relatively small areas to patch holes, depressions, and distressed areas in existing pavements. Appropriate hand or mechanical methods are used in placing and compacting the mix.

### **Manufactured Sand**

The predominately minus #4 (4.75 mm) material produced from crushing ledge rock or gravel.

### **Mechanical Spreaders**

Spreader boxes that are mounted on wheels. The spreaders are attached to and pushed by dump trucks (HMA boxes are pulled and chip spreaders are pushed).

### **Medium-Curing (MC) Asphalt**

Cutback asphalt composed of asphalt cement and a diluent of medium volatility.

### **Mesh**

The square opening of a sieve.

### **Microsurfacing**

A mixture of polymer modified asphalt emulsion, crushed dense graded aggregate, mineral filler, additives, and water. It provides a resurfacing of 10 to 20 mm (3/8 to 3/4 inch) to the pavement.

### **Milling Machine**

A self-propelled unit having a cutting head equipped with carbide-tipped tools for the pulverization and removal of layers of asphalt materials from pavements.

### **Mineral Dust**

The portion of the fine aggregate passing the 0.075 mm (No. 200) sieve.

### **Mineral Filler**

A finely divided mineral product at least 70 percent of which will pass a #200 (75 µm) sieve. Pulverized limestone is the most commonly manufactured filler, although other stone dust, hydrated lime, Portland cement, fly ash and certain natural deposits of finely divided mineral matter are also used.

### **Mixed-In-Place (Road Mix)**

An HMA course produced by mixing mineral aggregate and cutback or emulsified asphalt at the road site by means of travel plants, motor graders, or special road-mixing equipment.

### **Modified Binder**

These are asphalt binders, which have been physically- and/or chemically-altered (usually with an additive) to bring the characteristics of the binder to what is desired for the application. This process includes polymer modification.

### **Natural (Native) Asphalt**

Asphalt occurring in nature, which has been derived from petroleum through natural processes of evaporation of volatile fractions, leaving the asphalt fractions. The native asphalt of most importance is found in the Trinidad and Bermudez Lake deposits. Asphalt from these sources is often called lake asphalt.

### **Natural Sand**

A loose, granular material found in natural deposits.

### **Nondestructive Testing (NDT)**

In the context of pavement evaluation, NDT is deflection testing, without destruction to the pavement, to determine a pavement's response to pavement loading.

### **Open-Graded Aggregate**

A blend of aggregate particles containing little or no fine aggregate and mineral filler and the void spaces in the compacted aggregate are relatively large

### **Overlay**

The placement of hot asphalt over existing asphalt bound with a tack coat. Otherwise referred to as Resurfacing.

### **Pay Factor**

A calculated multiplier used to determine adjustments to payment to the contractor. Pay factors greater than 1.000 are referred to as “incentive” and pay factors less than 1.000 are referred to as “disincentive” or “penalties”

### **Pavement Structure**

The entire pavement system of selected materials from subgrade to the surface.

### **Percent Within Limits (PWL)**

A statistical estimation of the percentage of a material that falls between specified limits based on sampling and testing of the material. PWL is used to calculate the pay factor.

### **Performance Graded Asphalt (PG)**

The identification associated with the grading of the binder. Prior identification methods have been penetration and viscosity grading. For example, a PG 64-22 would indicate a performance-graded binder with a high temperature confidence of 64°C and a low temperature confidence of -22°C.

### **Permeability**

The resistance that an asphalt pavement has to the passage of air and water into or through the pavement.

### **Planned Stage Construction**

A construction process where stages of the project are performed sequentially according to design and a predetermined time schedule.

### **Plant Screens**

Screens located between the dryer and hot bins, which separate heated aggregates into proper hot bin sizes.

### **Plant (Cold) Mix**

A mixture, produced in an asphalt mixing facility that consists of mineral aggregate uniformly coated with asphalt binder, emulsified asphalt, or cutback asphalt.

### **Pneumatic-Tire Roller**

A compactor with a number of tires spaced so their tracks overlap delivering a kneading type of compaction.

### **Polished Aggregate**

Aggregate particles in a pavement surface that have been worn smooth by traffic.

### **Polymer-Modified Asphalt Binder**

Conventional asphalt cement to which one or more polymer compounds have been added to improve resistance to deformation at high pavement temperatures and often cracking resistance at low temperatures.

### **Potholes**

Bowl-shaped openings in the pavement resulting from localized disintegration.

### **Power Sweeper**

A power operated rotary broom used to clean loose material from the pavement surface.

### **Present Serviceability**

The ability of a specific section of pavement to serve its intended use in its existing condition.

### **Prime Coat**

An application of asphalt primer to an absorbent surface. It is used to prepare an untreated base for an asphalt surface. The prime penetrates or is mixed into the surface of the base and plugs the voids, hardens the top and helps bind it to the overlying asphalt course.

### **Pumping**

Slab deflection under passing loads sometimes resulting in the discharge of water and subgrade soils along joints, cracks, and pavement edges.

### **Quality Management of Asphalt (QMA)**

A specified quality control procedure where the contractor is responsible for the mix design and the control of the mix properties during production (see *IM 511* for additional information). The agency is responsible for quality assurance and verification.

### **Rapid-Curing (RC) Asphalt**

Cutback asphalt composed of asphalt cement and a naphtha or gasoline-type diluent of high volatility.

### **Raveling**

The progressive separation of aggregate particles in a pavement from the surface downward or from the edges inward.

### **Reclaiming Machine**

A self-propelled unit having a transverse cutting and mixing head inside a closed chamber, for the pulverization and mixing of existing pavement materials with asphalt emulsion. Asphalt emulsion (and mixing water) may be added directly through the machine by a liquid additive system and spray bar.

### **Recycled Asphalt Mix**

A mixture produced after processing existing asphalt pavement materials. The recycled mix may be produced by hot or cold mixing at a plant, or by processing the materials cold and in-place.

### **Recycled Asphalt Pavement (RAP)**

HMA removed and processed, generally by milling. This material may be stored and used in mixtures in addition to virgin aggregate and binder. This is also referred to as Reclaimed Asphalt Pavement.

### **Recycled Asphalt Shingles (RAS)**

Roofing shingles, either waste from a shingle manufacturer or tear off shingles from reroofing operations. Shingles contain a high percentage of asphalt as well as fibers and fine aggregate. Shingles are processed into a fine material and handled similar to RAP.

### **Reflection Cracks**

Cracks in asphalt overlays (usually over deteriorated PCC pavements) that reflect the crack or joint pattern in the pavement structure below it.

### **Residue**

The asphalt binder that remains from an asphalt emulsion after the emulsifying agent has broken and cured, or the remains of a cutback after the volatiles have cured.

### **Resilient Modulus of Elasticity**

A laboratory measurement of the behavior of pavement materials to characterize their stiffness and resiliency. A confined or unconfined test specimen (core or recompacted) is repeatedly loaded and unloaded at a prescribed rate. The resilient modulus is a function of load duration, load frequency, and number of loading cycles.

### **Roadway**

All facilities on which motor vehicles are intended to travel, such as Interstate highways, secondary roads, and city streets.

### **Rubblization**

The pulverization of a Portland cement concrete pavement into smaller particles, reducing the existing pavement layer to a sound, structural base that will be compatible with subsequent asphalt overlay.

### **Rutting (Channeling)**

Channeled depressions that sometimes develop in the wheel paths of an asphalt pavement, usually due to extreme temperatures combined with high wheel loads.

### **Sand**

Fine aggregate (any fraction below a No. 8 sieve), resulting from natural disintegration and abrasion or processing of rock.

### **Sand Asphalt**

A mixture of sand and asphalt binder, cutback, or emulsified asphalt. It may be prepared with or without special control of aggregate grading and may or may not contain mineral filler. Either mixed-in-place or plant-mix construction may be employed.

### **Saw-Cut and Seal**

A method of controlling reflective cracking in HMA overlays that involves construction of joints in the new overlay exactly over the joints in the existing pavement.

### **Scaling**

The peeling away or disintegrating of the surface of Portland cement concrete.

### **Seal Coat**

A thin asphalt surface treatment used to waterproof and improve the texture of an asphalt wearing surface. Depending on the purpose, seal coats may or may not be covered with aggregate. The main types of seal coats are aggregate seals, fog seals, emulsion slurry seals and sand seals.

### **Self-Propelled Spreaders**

Spreaders having their own power units and two hoppers. The spreader pulls the truck as it dumps its load into the receiving hopper. Conveyor belts move the aggregate forward to the spreading hopper.

### **Sheet Asphalt**

A hot mixture of binder with clean angular, graded sand and mineral filler.

### **Shoving**

A form of plastic movement resulting in localized bulging of the pavement.

### **Shrinkage Cracks**

Interconnected cracks forming a series of large blocks, usually with sharp corners or angles.

### **Sieve**

An apparatus for laboratory work in which the openings in the mesh are square for separating sizes of material.

### **Skid Hazard**

Any condition that might contribute to the reduction of friction forces on the pavement surface.

### **Skid Resistance**

The ability of a paved surface, particularly when wet, to resist to tire slipping or skidding. Proper asphalt content and aggregate with a rough surface texture are the greatest contributors. The aggregate must also resist polishing.

### **Slag**

A nonmetallic byproduct, consisting essentially of silicates and aluminosilicates of lime and of other bases that develops simultaneously with iron in a blast furnace, during steel production.

### **Slippage Cracks**

Crescent-shaped cracks resulting from traffic-induced horizontal forces that are open in the direction of the thrust of wheels of the pavement surface. They result when severe or repeated shear stresses are applied to the surface and there is a lack of bond between the surface layer and the course beneath.

### **Slurry Seal**

A mixture of emulsified asphalt, fine aggregate, and mineral filler, with water added to produce flowing consistency.

### **Soil/Cement Base**

A hardened material formed by curing a mechanically mixed and compacted mixture of pulverized soil, Portland cement and water used as a layer in a pavement system to reinforce and protect the subgrade.

### **Solubility**

A measure of the purity of asphalt binder (cement). The ability of the portion of the asphalt binder that is soluble to be dissolved in a specified solvent.

### **Source Properties**

Aggregate characteristics that must follow certain criteria to satisfy a Superpave mix design. They include Toughness, Soundness, and Deleterious Materials.

### **Spalling**

The breaking or chipping of a PCC pavement at joints, cracks, or edges, usually resulting in fragments with feathered edges.

### **Specific Gravity**

The weight to volume relationship of material in relation to water.



### **Stability**

The ability of asphalt paving mixtures to resist deformation from imposed loads. Unstable pavements are marked by channeling (ruts), and corrugations (washboarding). Stability is dependent upon both internal friction and cohesion.

### **Stationary Plants**

Asphalt plants that are so constructed that moving them is not considered economically feasible.

### **Steel-Wheel Static Rollers**

Tandem or three-wheel rollers with cylindrical steel rolls that apply their weight directly to the pavement.

### **Steel-Wheel Vibratory Rollers**

A compactor having single or double cylindrical steel rolls that applies compactive effort with weight and vibration. The amount of compactive force is adjusted by changing the frequency and amplitude of vibration.

### **Structural Overlay**

An HMA overlay constructed for the purpose of increasing the structural value and ride quality of the pavement system.

### **Subbase**

The course in the asphalt pavement structure immediately below the base course.

### **Subgrade**

The soil prepared to support a pavement structure or a pavement system. It is the foundation of the pavement structure.

### **Subgrade, Improved**

Subgrade that has been improved as a working platform by the incorporation of granular materials or stabilizers such as asphalt, lime, or Portland cement into the subgrade soil.

### **Superpave**

Short for "Superior Performing Asphalt Pavement", a pavement-based system for selecting and specifying asphalt binders and for designing asphalt mixtures.

### **Superpave Gyrotory Compactor**

A device used during Superpave mix design or quality control activities for compacting samples of hot mix asphalt into specimens used for volumetric analysis. Continuous densification of the specimen is measured during the compaction process.

### **Superpave Mix Design**

An asphalt mixture design system that integrates the selection of materials (asphalt, aggregate) and volumetric proportioning with the project's climate and design traffic.

### **Surface Course**

The top lift(s) of HMA pavement, sometimes called asphalt wearing course.

### **Surface Treatments**

A broad term embracing several types of asphalt or asphalt-aggregate applications, usually less than 1 in. (25 mm) thick, to a road surface. The types range from a light application of emulsified or cutback asphalt (Fog seal) to a single or multiple surface layers made up of alternating applications of asphalt and aggregate (chip seal).

### **Tack Coat**

A very light application of asphalt, usually asphalt emulsion diluted with water. It is used to ensure a bond between the existing pavement surface and the overlay.

### **Transverse Crack**

A crack that follows a course approximately at right angles to the centerline.

### **Travel Plants**

Self-propelled pugmill plants that proportion and mix aggregates and asphalt as they move along the road.

### **Truck Factor**

The number of ESALs contributed by one passage of a vehicle. Truck Factors can apply to vehicles of a single type or class or to a group of vehicles of different types.

### **Upheaval**

The localized upward displacement of a pavement, due to swelling of the subgrade or some portion of the pavement structure.

### **Viscosity**

A measure of a liquid's resistance to flow with respect to time. The higher the viscosity, the greater the resistance to flow.

### **Voids in the Mineral Aggregate (VMA)**

Void spaces that exist between the aggregate particles in the compacted mix, including spaces filled with asphalt binder. It represents the space available to accommodate effective volume of asphalt binder and air voids in the compacted mix.

### **Warm Mix Asphalt (WMA)**

A group of technologies which allow a reduction in the temperatures at which asphalt mixtures are produced and placed. The most common technologies are foaming, organic (wax) additives and chemical (emulsions), all of which act to reduce viscosity and increase workability of asphalt binder at a given temperature. WMA is fundamentally the same as HMA.

### **Well-Graded Aggregate**

Aggregate that is uniformly graded from coarse to fine.

### **Wet Mixing Period**

The interval of time between the beginning of application of asphalt materials into a pugmill and the opening of the discharge gate.

### **Workability**

The ease with which paving mixtures may be placed and compacted.

## HMA Paving Field Inspection Checklist

Duty	Frequency	Specification / Resource	Commentary
<b>Prior to HMA Placement</b>			
Check material certifications	As needed	Materials IMs	Check for accuracy and timeliness of required certification submittals. Do not allow incorporation of materials without required certifications.
Check proof rolling of subgrade	Everywhere, prior to final subgrade trimming. (when applicable)	Specification 2109.03, A, 10 Specification 2115.03, B, 2 Modified Subbase	All subgrades should be proof rolled with a sheep's foot roller no more than 1 week prior to trimming of the final grade. In addition, when Modified Subbase is used, the subgrade is to be proof rolled with a loaded truck to identify soft spots, etc.
Check trimmed subgrade	10/mile (when applicable)	Specification 2109.03, A, 10 (plus or minus 0.05 foot) IM 204	Check to ensure subgrade is trimmed to the proper cross slope and elevation. Usual check is by placing string across subgrade from stringline to stringline and measuring down to top of subgrade. When stringline is not available, a survey rod and level may be used. Laser levels have been used but are less common. GPS rovers have also been used, but are not accurate enough to measure within the specification tolerances.
Check trimmed subbase (modified)	10/mile (when applicable)	Modified Subbase Specification 2115.03 (plus 0 and minus 0.05 foot) IM 204 Appendix C	Check to ensure subbase is trimmed to the proper cross slope and elevation. This, along with the subgrade checks, will ensure proper subbase thickness. Usually checked by placing string across subbase from stringline to stringline and measuring down to top of subbase. When stringline is not available, a level may be used. Laser levels have been used but are less common. The width of the subbase should also be checked at this time to ensure that the proper placement width is being achieved.
Check slab fracturing of existing PCC pavement	Periodically (when applicable)	Specification section 2216 Specification section 2217	<b>Cracking and Seating:</b> Use test section to ensure process used to fracture PCC slab results in specified crack spacing and consistency. Rolling must be adequate to ensure contact/support by underlying base without damage to aggregate interlock. <b>Rubblization:</b> Ensure equipment and process used to fracture pavement results in uniform and appropriate size fragments, based on visual inspection of surface. Verify multiple passes with a vibratory roller to compact and seat the fragments, as well as remove distortion prior to HMA overlay.
Check pavement scarification	Periodically	Specification section 2214	Verify equipment to be used is wide enough and suitable for the method of operation. Check that the scarification is to the specified depth, and results in a cross-section that is true within the specification tolerance. Ensure that all millings are removed and stored / stockpiled in compliance with contract documents.
Sampling & Testing RAP	First Day + One per week	Specification 2318.02 IM 204 App. K	Determine frequency / timing of random sampling. Take 10 lb. sample & test to determine maximum RAP size. Ensure top size does not exceed 50% of the depth of the compacted recycled mat.
Sampling CIR stabilizing agent (foamed asphalt)	One per day (First day + one per week to District lab)	Specification 2318.03, I, 2 IM 204 App. K Form 820193	Determine frequency / timing of random sampling. Take 1 qt. sample (or direct & witness sampling by contractor) & deliver to DME lab for verification testing (maintain agency custody) or, identify (Form 820193) and secure samples for transportation by others.

## HMA Paving Field Inspection Checklist

Duty	Frequency	Specification / Resource	Commentary
Sampling CIR stabilizing agent (standard emulsion)	One per day (First day + one per week to District lab)	Specification 2318.03, I, 2 IM 204 App. K IM 360 Form 820193	Determine frequency / timing of random sampling. Take 1 qt. sample in a plastic bottle (or direct & witness sampling by contractor) & deliver to DME lab for verification testing (maintain agency custody) or, Identify (Form 820193) and secure samples for transportation by others.
Sampling uncompacted CIR mixture	One per lot	Specification 2318.03, I, 6 IM 204 App. K IM 504 Form 820193	Determine frequency / timing & location of random sampling. Take 40 lb. sample in a sealed container (or direct & witness contractor sampling) & deliver to DME lab for verification testing (maintain agency custody) or, Identify (Form 820193) and secure samples for transportation by others.
Direct & witness moisture & density testing on compacted CIR layer	10 per lot	Specification 2318.03, I, 6 IM 204 App. K IM 504	Determine & layout moisture and density test random locations. Direct & witness contractor performing nuclear gauge moisture & density testing within 24 hours of completing each lot. Recompact sublots that do not achieve minimum required density.
Check preparation of existing surface	Periodically + prior to HMA overlay	Specification 2212.03, B, 1 Specification 2303.03, C, 2	Check repair/patching of existing base pavement is as required by specification, plans or as otherwise directed by Engineer. Prior to HMA resurfacing, ensure that the base pavement is free from all foreign materials & debris.
Check / Inspect contractor's equipment (general)	Daily, or as needed	Specification 1107.08 Specification Section 2001	Before use on project, ensure that equipment to be used is of the type & size (and has required features) necessary to meet the specifications and perform the work intended; While in use, be sure that the equipment is properly operated and maintained to insure the safety of workers, inspectors and traveling public.
Check / Inspect haul trucks	Initial use & as needed	Specifications 2001.01 & 2001.03	Haul trucks must have tight metal or metal-lined bodies. Haul trucks must be equipped with a tarp, but are not typically required to be used between May 15 & October 1. Truck bodies are to be kept clean by heating, scraping, or use of approved release agents. Check trucks for fluid leaks and remove from service if necessary.
Check for proper use of release agents	Daily, or as needed	Specification 2001.01, D IM 491.15	Approved release agents are listed in IM 491.15. Diesel fuel, distillates or solvents are not acceptable release agents. Trucks found to have used improper release agents shall be removed from service and allowed to drain for a minimum of 5 hours before subsequent use hauling HMA. Do not allow cleaning solutions to be carried on a paver while in operation.
Check / Observe loading of HMA haul trucks at plant	Periodically	Specification 2303.03, C, 3, d	Check for signs of overheated mix (blue smoke). Check for clumps of cold mix remaining from previous load. Check mixing time and mix appearance for proper coating of aggregate. Check for proper and uniform mix temperature. Check that multiple drops of mix from the silo are used to minimize segregation (roll-down) of mix in trucks.
Check existing pavement surface temperature	Daily, before start-up	Specification 2303.03, C, 4	HMA shall not be placed when temperature of the shaded portion of road is less than shown in specification. Minimum temperature is based on thickness and location of lift to be placed. The Engineer may further limit placement if other conditions exist that would be detrimental to quality work.

## HMA Paving Field Inspection Checklist

Duty	Frequency	Specification / Resource	Commentary
Check stringline	Daily, or as needed	Specification 2303.03, C, 4, f	Check for proper placement of stringline to identify centerline, guide paver and maintain alignment. Stringline should be held in place by nails. Additional nails, at reduced spacing, should be used to produce a smooth transition (reduce the "chord" effect) through horizontal curves. Check and correct edge alignment irregularities immediately, to minimize mismatched joints and other resulting problems.
Check for approval and proper use of MTV	Prior to initial use on project, and then periodically while in use	Construction Manual section 8.80	Before material transfer vehicles (MTVs) may be used on a DOT project, approvals must be obtained from the Office of Design and Office of Bridges & Structures. Conditions on approval must be observed, and MTV use monitored by inspector. If cracking or distress in the underlying pavement occurs, the equipment must be removed from the project and appropriate repairs made at the contractor's expense.
Check / Inspect tack distributor	Once each distributor	Specification 2001.12	Check that distributor is equipped with an accurate thermometer, burner & means of circulating the material, as well as manufacturer's instructions for use. Check that distributor has either been calibrated, or has a valid annual certification of calibration. Check for fluid leaks.
Check / Inspect HMA paver	Once each paver, and when modifications made	Specification 2001.19 Specification 2303.03, B, 2	Check that paver is of type and size capable of placing and initially compacting an HMA mixture. Check that paver is equipped with well-matched screed sections, with vibration along its entire length (including extensions). Ensure that paver is equipped with automatic screed controls to regulate thickness and crown, along with grade and slope control system and approved grade referencing system.
Check / Inspect HMA rollers	Once each roller, and when modifications made	Specification 2001.05 Specification 2303.03, B, 3	<b>Steel Drum:</b> Ensure proper drum size, equipped with properly operating water system and scraper bars. <b>Vibratory:</b> Should be operating at high frequency / low amplitude (can verify frequency of vibration using a Reed tachometer, if desired), with both drums vibrating similarly. <b>Pneumatic:</b> Tire size and tire (contact) pressures as specified. Check all rollers for fluid leaks.
Check tack coat application for uniformity, coverage & curing	Daily	Specification 2303.03, C, 2, b	Check that tack coat application coverage is uniform. Make sure that all spray nozzles are functioning, and providing a fan-shaped spray with uniform overlap. The tack application is properly cured when it feels "tacky" vs. slick underfoot, and its appearance changes from a brownish cast to black.
Check tack coat application rate (yield)	Daily, or as needed	Specification 2303.03, C, 2, b	Compare daily quantity available from Plant Report or Plant Monitor with area covered with tack coat to verify the application rate is within specification range.
Check for wet or damp existing pavement surface	As conditions warrant	Specification 2303.03, C, 4	HMA paving should not start if wet conditions exist, or rainfall is imminent. If paving is underway and rainfall begins, paving must stop. Paving may resume provided pavement is dry, tack coat is undamaged, and delivered HMA is of sufficient temperature.

## HMA Paving Field Inspection Checklist

Duty	Frequency	Specification / Resource	Commentary
<b>During HMA Placement</b>			
Collect individual HMA load tickets	Periodically	Specification 2001.07, B	Ensure that all HMA load tickets are accounted for, and periodically check actual mix quantities (vs. plans) to guard against unexpected project over-runs.
Check HMA placement operation (general)	Periodically	Specification 2303.03, C, 3, d Specification 2303.03, C, 4	HMA should be supplied to the paver in a uniform and continuous manner, resulting in a minimal number of paver stoppages. HMA placement operation shall produce a mat with uniform temperature and composition, minimizing segregation to the extent that it is not visibly observed in the compacted surface.
Check / Observe unloading of truck into paver hopper	Periodically	Specification 2303.03, C, 3, d	Check for signs of overheated mix (blue smoke). Check for clumps of cold mix remaining from previous loads. Ensure proper dumping procedures used to keep mix flowing as a mass, to minimize coarse aggregate roll-down (segregation).
Check / Observe proper placement of mix into windrow	Periodically	Specification 2303.03, C, 3, d	Check that windrow is centered in lane to be placed. Check for uniformity of windrow size & shape. Check for excessive mix drop heights, leading to coarse aggregate segregation at base of windrow. Check for clumps of cold mix near end of loads. Ensure that haul trucks are not allowed to drive over (compact) existing windrow.
Check for uniform material flow through paver	Periodically	Specification 2303.03, C, 3, d	Restrictions to uniform flow of mix will result in segregation. Non-uniform head of material at the screed will result in waves in the mat, as well as variations in density. Check for uniform head of material in the paver hopper (typically 25 to 75% full), through the flow gates, along length of augers, and ahead of the screed.
Check temperature of uncompacted mat behind paver	Every two hours, or as needed	Specification 2303.03, C, 3, d	Check that temperature of mat is above applicable specification minimum for the location and thickness of lift being placed. Consistent mat temperatures are needed to ensure uniform compaction and resulting density.
Check / Observe uncompacted mat quality behind paver	Periodically	Specification 2303.03, C, 3, d	Check for non-uniform appearance (streaking, coarse / open texture, screed marks). Check for evidence of leaking fluids from equipment and take immediate action to remove equipment from operation if discovered.
Check / Observe loose (uncompacted) lift depth checks	Periodically	Specification 2303.03, C, 4	Ensure that the HMA mixture is spread at a depth such that, when compacted, will result in the required thickness. More frequent checks should be made on the first lift over an uneven surface, and following an adjustment to the screed. After adjusting screed, allow time for the screed to level out (approx. 5X tow arm length) before making subsequent checks.
Check / Observe HMA compaction (roller) operation	Periodically	Specification 2303.03, C, 5	Check for proper equipment and procedures. Check for consistent mat temperature & rolling pattern (with special attention to Class II compaction areas); Check surface for roller marks, mix pick-up, waves in mat, and possible segregation.
Check mat width & cross-slope	Periodically, and when plan width or cross-slope changes	Project plans	Periodically check both the uncompacted and compacted mat width and adjust, as necessary, to account for "roll out". More frequent checks should be made when the plan width changes. Checks of mat cross-slope should be made periodically, with additional emphasis in transition areas of super-elevated curves.

## HMA Paving Field Inspection Checklist

Duty	Frequency	Specification / Resource	Commentary
Check longitudinal joints	Periodically	Specification 2303.03, C, 6	Check for proper overlap (typically 1" within 1/2" tolerance) and procedures used for longitudinal joint construction. Pavement edges should be carefully aligned and loose lift thickness set to result in well-matched centerline joint. Check for adequate mix at end of screed to reduce potential for segregation and mismatched joint.
Check longitudinal pavement runouts	As needed	Specification 2303.03, C, 6 Project plans	Check for proper runout at structures, existing pavement, and at end of day headers. For a transverse construction joint open to traffic, the runout is 10 ft. in length per inch of lift thickness. For permanent runouts, the length is shown on the plans, based on posted speed and overlay thickness. Check that runout design fits existing conditions.
Check transverse joints	As needed	Specification 2303.03, C, 6	Ensure header is sawed in straight line at right angles to provide a full depth vertical edge to match at joint. Check transverse joint off header at start-up for smoothness, using a 10 ft. straight edge. Corrections may be required before continued paving.
Check mix quantities & yields	Every two hours recommended	Project plans	Comparison should be made between the tons of HMA delivered/placed and the plan quantity (tons) of HMA calculated for a given area of pavement. Typically, the quantity placed will be within 5% of the quantity calculated using the plan rate.
Direct & witness sampling of asphalt binder	Daily	Specification 2303.03, D, 3, b, 1 IM 204 App. F IM 323 Form 820193	Direct & witness random sampling procedures by contractor personnel. Take possession of sample & deliver to field lab for testing (maintain agency custody) or, identify (Form 820193) and secure samples for transportation by others.
Direct & witness sampling of aggregates (cold-feed)	First day	Specification 2303.03, D, 3, b, 2 IM 204 App. F IM 301 Form 820193	Direct & witness random sampling procedures by contractor personnel. Take possession of sample & deliver to field lab for testing (maintain agency custody) or, identify (Form 820193) and secure samples for transportation by others.
Direct & witness sampling of loose / uncompacted mix (hot box)	One per subplot (up to 5 per day)	Specification 2303.03, D, 5, b IM 204 App. F IM 322 Form 820193	Determine frequency / timing of random sampling & notify contractor. Direct & witness sampling procedures by contractor personnel. Take possession of sample & deliver to field lab for testing (maintain agency custody) or, identify (Form 820193) and secure samples for transportation by others.
Direct & witness sampling of compacted mix (field density cores)	Daily (min. 8 cores per lot)	Specification 2303.03, D, 4, a IM 204 App. F IM 320 Construction Manual Section 8.13 Form 820193	Determine & layout density core random locations. Direct & witness core drilling. Measure & inspect cores for defects & proper dimensions. Take possession of cores & deliver to field lab for testing (maintain agency custody) or, identify (Form 820193) and secure samples for transportation by others.
Perform testing on compacted field density cores	Daily (min. 8 cores per lot)	Specification 2303.03, D, 5, c IM 204 App. F IMs 321 and 337	Following contractor preparation (cutting / trimming) of the core samples for testing, the cores are measured and tested (weighed) by inspection personnel to determine field density. Results should be agreed to by inspection and contractor personnel to avoid disputes later.



## HMA Paving Field Inspection Checklist

Duty	Frequency	Specification / Resource	Commentary
<b>After HMA Placement</b>			
Check for Safety Edge or temporary granular fillet at pavement edge	Each time (prior to removing traffic control)	Specification 2305.03, A Specification 2121.03, C, 4, b	Safety Edge or temporary granular fillet is required to mitigate droppoff at pavement edge prior to moving traffic control and opening an adjacent lane to traffic.
Check completed pavement section visually for uniformity	Daily, or as needed	Construction Manual Section 2.53 Form 830245 Construction Manual App. 2-34(K)	Daily visual examination of mat surface is recommended to detect mix segregation as soon as possible, allowing timely changes in equipment or procedures to be made in order to minimize future occurrences. If segregation is suspected, the inspector should inform his supervisor, and the contractor. A Noncompliance Notice (Form 830245) and subsequent price adjustment may follow, if warranted.
Check milled rumble strip placement	Periodically	Road Standards PV-12 and PV-13 Specification Section 2548	Milled rumble strips may be placed on the shoulder or centerline of the roadway. They are placed in the compacted HMA after mat has sufficiently cooled to resist tearing. Rumble strip placement should be checked to ensure proper spacing, depth, and location requirements are being met.
Check fog seal application coverage, uniformity & rate	Periodically	Specification 2548.03, C Specification 2308.03, D	Ensure that asphalt emulsion is not placed on a wet or damp surface. The fog seal application must uniformly cover the entire milled rumble strip, at the rate specified.
Review initial contractor smoothness information	Daily, until 3 consecutive days of 100% pay or better	Specification 2317 Specification 2316 IM 341	The contractor is required to submit smoothness information daily until they have paved for three consecutive days resulting in 100% payment or better. There are several reasons for this requirement. First is to identify if there are equipment or process issues causing placement problems in the paving operation. It is not desirable to allow the contractor to continue paving if acceptable smoothness levels are not being achieved. This requirement also may identify problems in the contractor's smoothness evaluation. It also gives inspection staff the opportunity to review the contractor's profilograph settings to make sure they are correct.
Review final contractor smoothness information	After submittal of final profilograph reports and traces	Specification 2317 Specification 2316 IM 341	The contractor is required to submit all final profilograph reports and traces to the Engineer within 14 days after completion of paving. After receipt of all final reports and traces, the information should be reviewed to ensure that all sections of pavement have been evaluated. In addition, the smoothness information should be evaluated to determine if the incentive or disincentive requested by the contractor is accurate.

## HMA Paving Field Inspection Checklist

Duty	Frequency	Specification / Resource	Commentary
<b>General</b>			
Check for contractor compliance with Public Convenience and Safety requirements	Daily	Specification 1107.08	Check for compliance with on-the-road and off-the-road times (30 minutes after sunrise & 30 minutes before sunset, unless state otherwise in contract documents). Check that contractor operates equipment and performs their operations in a manner that provides safety for workers and traveling public.
Check traffic control	When approaching or travelling within work zone	Specification Section 2528 Project plans	Even though traffic control checks are a responsibility of the contractor, if problems or deficiencies are observed, inform the contractor when the observations are made so that corrections can be made in a timely manner. Specific areas to observe include traffic control, work zone length, flaggers, signing and pilot car operation.
Check contractor's traffic control daily diary	As needed	Specification 2528.1, C	The contractor is required to check traffic control and record significant information. It is a good practice to review the contractor's diary occasionally to ensure that documentation is being recorded as required. For instance, after noting damaged signing or deficiencies in the traffic control devices or setup, review the daily diary to ensure the deficiencies and the remedies are recorded.
Monitor the project for fugitive dust	Daily	Specification 1107.07, E	The contractor is responsible for controlling fugitive dust on the project. When dust is being generated and leaving the project site, the contractor should be reminded of their responsibility to control dust and a request should be made to take measures to do so. In urban areas, it is even more critical that dust be controlled as property owners will be more sensitive to dust generated by the project.
Monitor contractor haul roads	Daily	Construction Manual 2.12	The contractor is required to submit a request for haul road designation for roads used to haul materials for the project. Once designated as a haul route, the contractor is expected to use the haul route for the designated purpose. The contractor's operations should be observed daily to ensure that haul traffic is using the appropriate, approved haul routes.
Check for compliance with winter shutdown requirements	When applicable	Specification 2121.03, C Specification 2214.03, D Specification 2303.03, C, 6 Specification 2318.03, J Specification 2527.03	Ensure that following requirements are met prior to end of season on projects with winter shutdown period: Granular shoulder brought up to edge of pavement at design slope and width; All scarified surfaces covered with at least one full HMA lift; Headers shall be located across from each other; Temporary runouts shall be located adjacent to each other and be 25 feet in length per inch of lift thickness; Cold in-place recycled surfaces shall be covered with at least one full lift of HMA; All pavement markings completed (including edge lines and symbols).
Issue Noncompliance Notice	As required	Construction Manual Section 3.21 Form 830245	The owner is obligated to notify the contractor in writing when noncompliance occurs. This is done using Form 830245. Noncompliance Notices should be issued as quickly as practical after observation of the noncompliance to give the contractor ample time to take corrective action. The Noncompliance Notice also provides a written record of notification being provided to the contractor.



**DEVELOPMENTAL SPECIFICATIONS  
FOR  
ELECTRONIC TICKETING**

**Effective Date  
October 17, 2023**

**THE STANDARD SPECIFICATIONS, SERIES 2023, ARE AMENDED BY THE FOLLOWING MODIFICATIONS AND ADDITIONS. THESE ARE DEVELOPMENTAL SPECIFICATIONS AND THEY SHALL PREVAIL OVER THOSE PUBLISHED IN THE STANDARD SPECIFICATIONS.**

**23032.01 DESCRIPTION.**

- A.** This work shall consist of providing electronic material tickets for all loads of flexible paving mixture or ready mixed PCC delivered to the project. Electronic ticketing will only be required for the primary material supplied to the project, i.e. flexible paving mixture for an HMA resurfacing project or PCC for a PCC paving project. Electronic tickets for other materials supplied to a project may be submitted at the Contractor's option. The Contractor/supplier can use the plant ticketing system of their choice to create the material ticket data.
- B.** Ticket data shall include the following:
  - 1.** After each truck is loaded, ticket data must be electronically captured, and ticket information uploaded via web service / Application Programming Interface (API) to the agency.
  - 2.** Material ticket data will be submitted to <https://iowa.dot-portal.io> via an HTTPS POST as JSON documents. Include the API key specific to each customer in each request as an HTTP header.
  - 3.** Material supplier must test to confirm that ticketing data can be shared from the originating system no less than 30 days prior to project start. Topic shall be discussed at the preconstruction meeting.
  - 4.** Ticket data must be available immediately upon project start so there are no delays to viewing tickets.

5. Provide the same data that is currently accessible and viewed by agency users previously on printed tickets specific to state projects.
6. Transmit ticket data before the truck leaves the plant and transmit any updates to the ticket data within 5 minutes of a change.

DS-23032, Page 2 of 3

### **23032.02 CONSTRUCTION DATA.**

Contractor shall submit material ticket data in accordance with the plant manufacturer's system recommendations to provide the following.

**A.** Net weight (or volume for ready mix concrete) of material being transported (to nearest 0.01 ton or cubic yard).

**B.** Running daily total of net weight of material (or volume for ready mix concrete) being transported (to the nearest 0.01 ton or cubic yard).

**C.** Each material ticket shall contain the following:

#### **1. General Ticket information (All Material).**

- a. Date.
- b. Iowa DOT Project Number.
- c. Name of Contractor
- d. Name of material supplier.
- e. Unique truck ID.
- f. Plant/scale name (source).
- g. Truck Status Times:
  - 1) Loaded time (time batched) shall be available.
  - 2) Provided other truck status times as available.
    - a) Ticketed.
    - b) Load time.
    - c) Left plant.
    - d) Arrive at project.
    - e) Begin unload.
    - f) Finish unload.
    - g) Leave project.

#### **2. Portland Cement Concrete.**

- a. Loaded time (water/cement time).
- b. Wet and dry batch weights (if computer generated).
- c. Water:
  - 1) In aggregate.
  - 2) Total water.
  - 3) Water/cement ratio.
  - 4) Max water/cement ratio. 5) Allowable water to add.
- d. Admixtures (including brand names if available):
  - 1) Retarder and weights.
  - 2) Water reducer and weights.
  - 3) Air entrainment and weights.

- 4)** Special performance admixtures and weights. **5)** Concrete fibers.
- e.** Cementitious material(s) and weights.
- f.** CPI Name and certificate number.

**3. Flexible Pavement Mixture.**

- a.** Type of material.
- b.** Gross weight (if not automatic weighed).
- c.** Tare weight (if not automatic weighed).
- d.** Net weight.
- e.** Mix design number.

DS-23032, Page 3 of 3

**23032.03 METHOD OF MEASUREMENT.**

None.

**23032.04 BASIS OF PAYMENT.**

Payment for electronic ticketing will be incidental to the material being provided.