

DELIMITING AREAS

GENERAL HIGHWAY AND TRANSPORTATION MAP

POLK COUNTY IOWA

PREPARED BY THE IOWA DEPARTMENT OF TRANSPORTATION DIVISION OF PLANNING AND RESEARCH OFFICE OF TRANSPORTATION INVENTORY

PHONE (515) 239-1289

IN COOPERATION WITH

UNITED STATES DEPARTMENT OF TRANSPORTATION FEDERAL HIGHWAY ADMINISTRATION

1986



LEGEND

- COUNTY LINE
CIVIL TOWNSHIP
CORPORATION LINE
SECTION LINE
WATERWAY: STREAM
NARROW STREAM
WIDE STREAM
HIGHWAY BRIDGE SMALL
HIGHWAY BRIDGE LARGE
RAILROAD STATION
RAILROAD BELOW OVERHEAD
RAILROAD OVER SUBWAY
RAILROAD SINGLE OPERATING COMPANY
RAILROAD ELECTRIC
PIPE LINE GAS
PIPE LINE OIL
STATE CAPITAL
CENTER OF CITIES
CENTER OF STATE CAPITAL
RAILROAD GRADE CROSSING
UNIMPROVED ROAD (RURAL)
GRADED AND DRAINED ROAD
SOIL SURFACED ROAD
METAL SURFACED ROAD
BITUMINOUS SURFACED ROAD
PAVED ROAD
HIGHWAY WITH PARTIAL CONTROL OF ACCESS
HIGHWAY WITH FULL CONTROL OF ACCESS

LEGEND

- AUTO JUNK YARD
SANITARY LAND FILL
HIGHWAY GARAGE
DRIVE IN THEATER
RACE COURSE
CAMP GROUNDS
BOOSTER STATION
NURSERY
AIRPORT, LIMITED FACILITIES

LEGEND

- FARM UNIT
DWELLING OTHER THAN FARM
ROWS OR GROUPS OF DWELLINGS
STORE OR SMALL BUSINESS ESTABLISHMENT
SCHOOL OR OTHER EDUCATIONAL INSTITUTION
CHURCH OR OTHER RELIGIOUS INSTITUTION
CEMETERY
GAUGING OR PUMPING STATION
POWER PLANT
AIRPORT, COMPLETE FACILITIES
CAMP OR LODGE
RADIO STATION
GOLF COURSE OR COUNTRY CLUB
AIRWAY BEACON LIGHT
GRAVEL PIT
TRIANGULATION STATION
COUNTY HOME
PICNIC GROUNDS
UNIFIED STATES HIGHWAY
STATE HIGHWAY SYSTEM
COUNTY HIGHWAY SYSTEM
STATE OR FEDERAL PROPERTY (NAMED)
DELIMITING AREA (GENERALIZED)
FEDERAL AID HIGHWAY SYSTEM
POINTS BETWEEN WHICH DISTANCES ARE MEASURED
END OF FEDERAL AID
LEGAL ROAD NOT OPEN TO TRAFFIC
4-LANE UNDIVIDED HIGHWAY
SMALL PARK (STATE/COUNTY)
INTERSTATE HIGHWAY
DIVIDED HIGHWAY

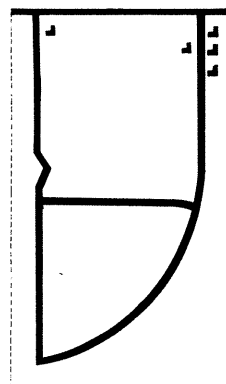
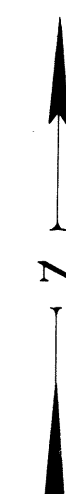

CAPITOL CITY PARK SEC. 16 WEBSTER TWP. T-79N, R-25W ENLARGED 8.8 TIMES

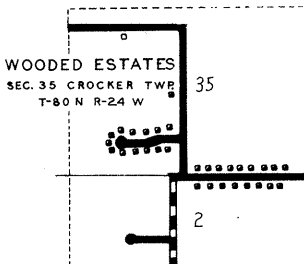

WOODED ESTATES SEC. 35 CROCKER TWP. T-80N, R-24W ENLARGED 5.3 TIMES

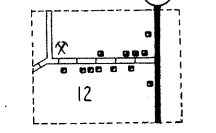

ZOOK SPUR DALLAS COUNTY SEC. 12 DES MOINES TWP. T-81N, R-26W SCALE: 6 1/4 MILE

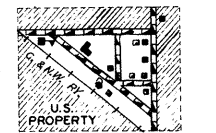

HERROLD SEC. 22, 23 JEFFERSON TWP. T-80N, R-25W SCALE: 5 1/4 MILE

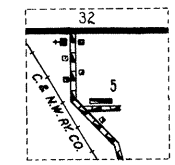

CROCKER SEC. 32 LINCOLN TWP. T-80N, R-24W SCALE: 5 1/4 MILE

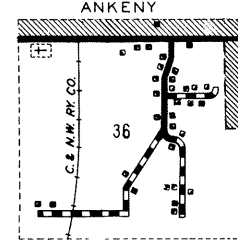

ORALABOR SEC. 25 CROCKER TWP. T-80N, R-24W SCALE: 5 1/4 MILE

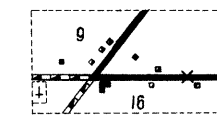

WHITE OAK SEC. 9 ELKHART TWP. T-81N, R-23W SCALE: 3 1/4 MILE

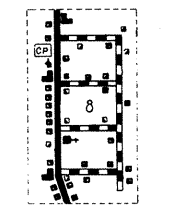

FARRAR SEC. 23, 24 WASHINGTON TWP. T-81N, R-22W SCALE: 1 1/4 MILE

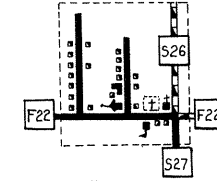

BERWICK SEC. 6 DELAWARE TWP. T-79N, R-23W SCALE: 6 1/4 MILE

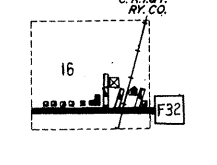

ENTERPRISE SEC. 16 DOUGLAS TWP. T-80N, R-23W SCALE: 3 1/4 MILE

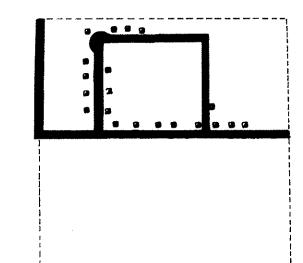

ROYAL ESTATES SEC. 31 MADISON TWP. T-80N, R-25W ENLARGED 5.3 TIMES

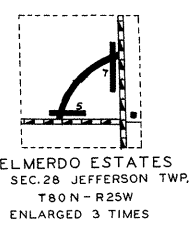

ELMERDO ESTATES SEC. 28 JEFFERSON TWP. T-80N, R-25W ENLARGED 3 TIMES

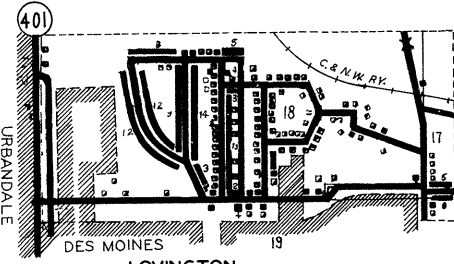

LOVINGTON SEC. 13, 16, 17 WEBSTER TWP. T-79N, R-25 1/2 W SCALE: 4 1/4 MILE

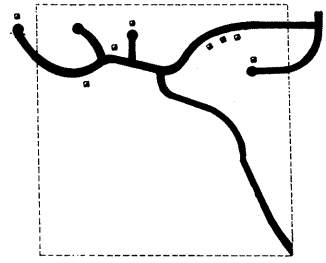

DEER CREEK SEC. 30 WEBSTER TWP. T-79N, R-25W ENLARGED 5.3 TIMES

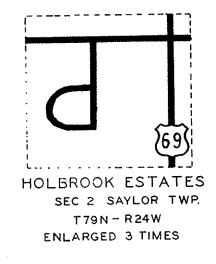

HOLBROOK ESTATES SEC. 2 SAYLOR TWP. T-79N, R-24W ENLARGED 3 TIMES

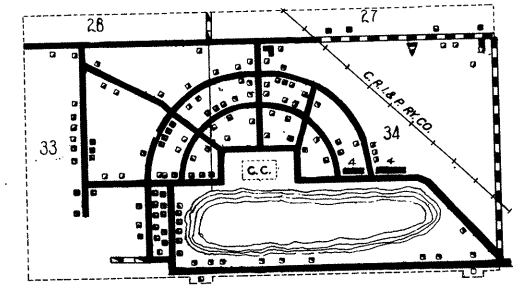

AVON STATION SEC. 28, 27 ALLEN TWP. T-78N, R-23W SCALE: 1 1/2 MILE

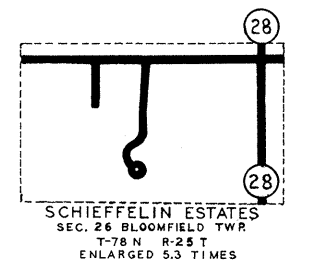

SCHIEFFELIN ESTATES SEC. 26 CROCKER TWP. T-80N, R-25T ENLARGED 5.3 TIMES

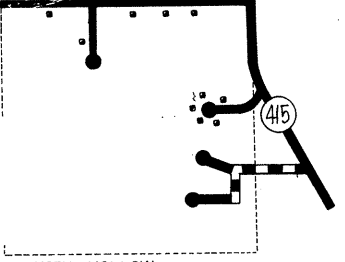

HICKORY HOLLOW SEC. 20 CROCKER TWP. T-80N, R-24W ENLARGED 5.3 TIMES

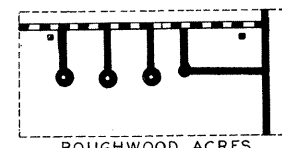

ROUGHWOOD ACRES SEC. 15 WEBSTER TWP. T-79N, R-25W ENLARGED 5.3 TIMES

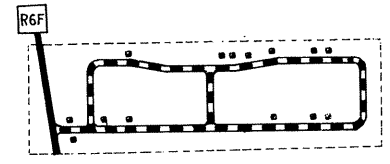

WINDMILL ESTATES SEC. 9 JEFFERSON TWP. T-80N, R-25W ENLARGED 5.3 TIMES

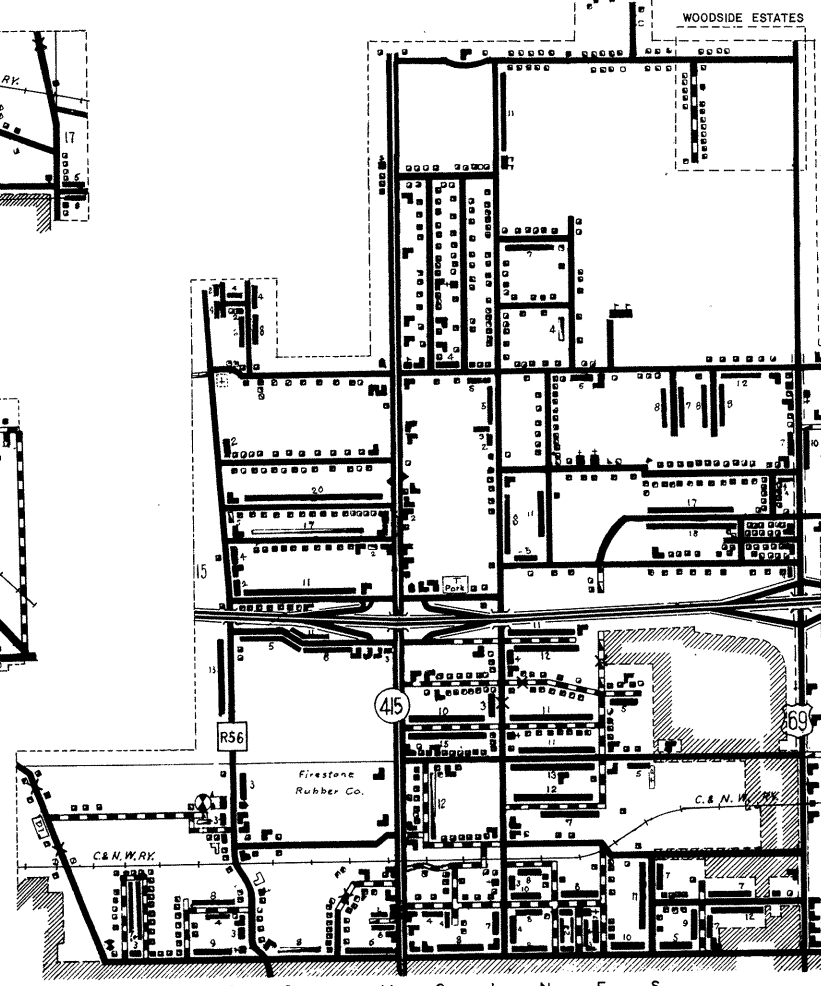

DES MOINES NORTH ACRES SEC. 15, 14, 11 SAYLOR TWP. T-78N, R-24W SCALE: 4 1/4 MILE

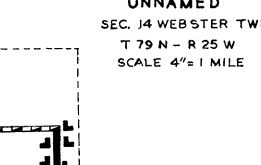

UNNAMED SEC. 14 WEBSTER TWP. T-79N, R-25W SCALE: 4 1/4 MILE

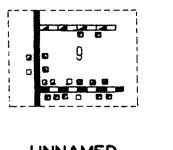

UNNAMED SEC. 9 SAYLOR TWP. T-79N, R-24W SCALE: 3 1/4 MILE

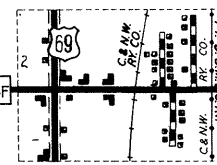

UNNAMED SEC. 2, 1 SAYLOR TWP. T-79N, R-24W SCALE: 3 1/4 MILE

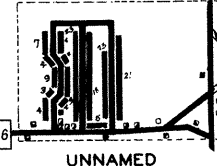

UNNAMED SEC. 27 DELAWARE TWP. T-79N, R-23W SCALE: 3 1/4 MILE

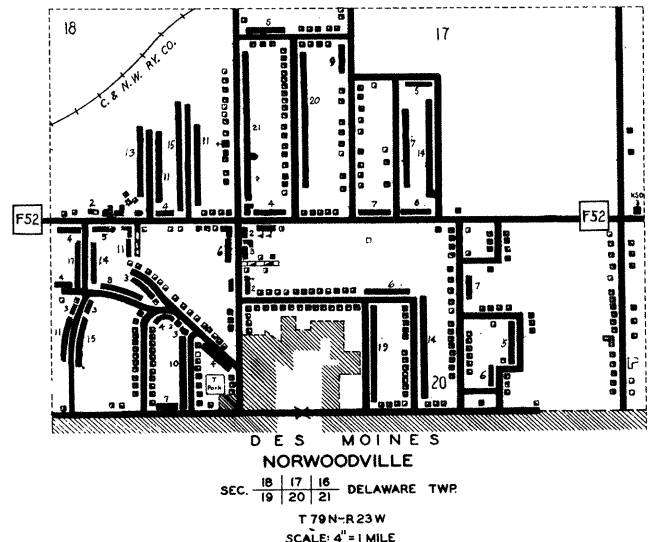

DES MOINES NORWOODVILLE SEC. 18, 17, 16 DELAWARE TWP. T-79N, R-23W SCALE: 4 1/4 MILE

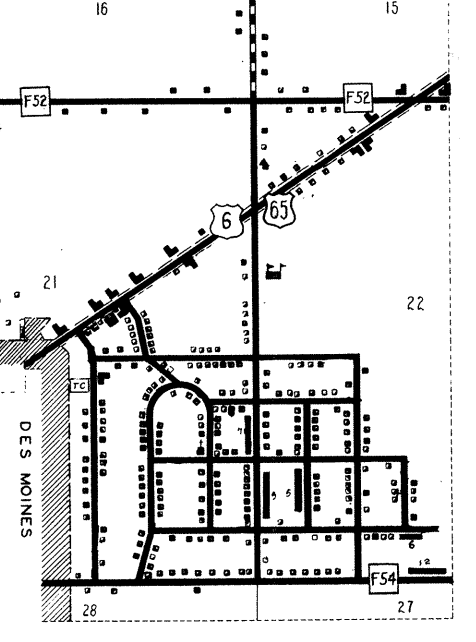

CAPITOL HEIGHTS SEC. 16, 15 DELAWARE TWP. T-79N, R-23W SCALE: 5 1/4 MILE

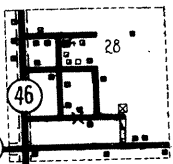

AVON SEC. 28, 28 ALLEN TWP. T-78N, R-23W SCALE: 3 1/4 MILE

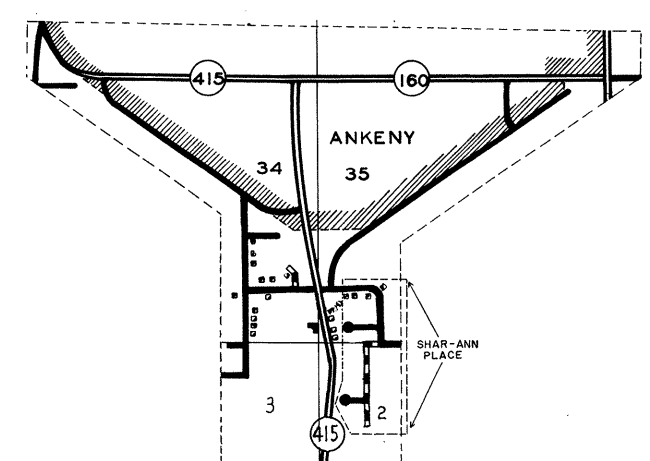

ANKENY SEC. 34, 35 CROCKER TWP. T-80N, R-24W SCALE: 3 1/4 MILE

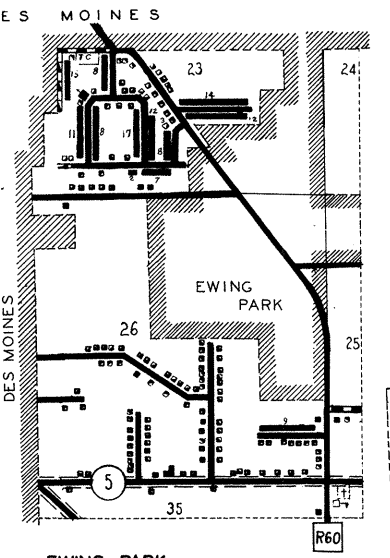

EWING PARK SEC. 22, 23, 24 BLOOMFIELD TWP. T-78N, R-24W SCALE: 5 1/4 MILE

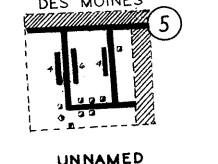

UNNAMED SEC. 10 SAYLOR TWP. T-79N, R-24W SCALE: 5 1/4 MILE

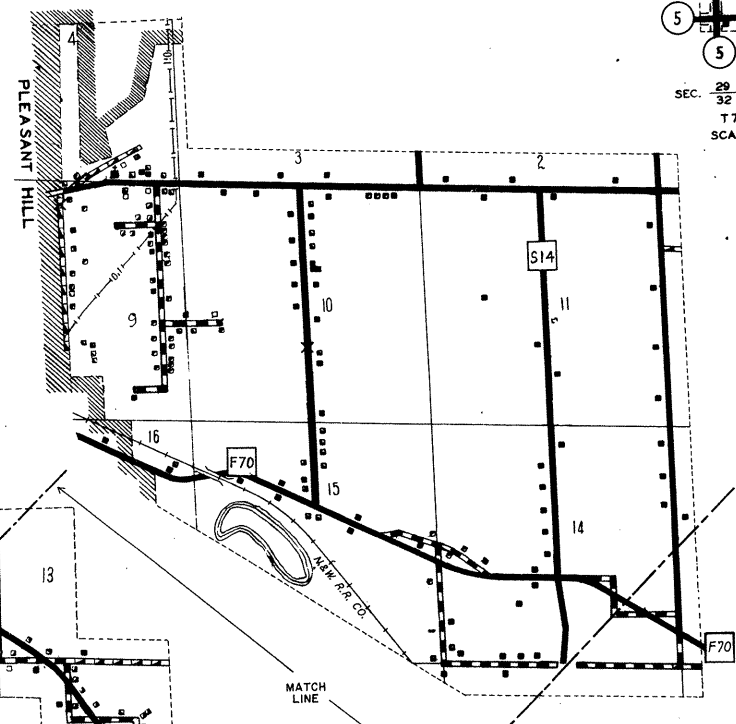

SAYLORVILLE SEC. 3, 1 SAYLOR TWP. T-79N, R-24W SCALE: 2 1/2 MILE

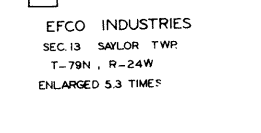

EFCO INDUSTRIES SEC. 13 SAYLOR TWP. T-79N, R-24W ENLARGED 5.3 TIMES

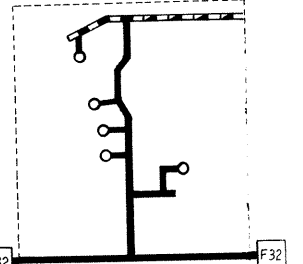

GREENWOOD ACRES SEC. 18 DOUGLAS TWP. T-80N, R-23W ENLARGED 2.5 TIMES

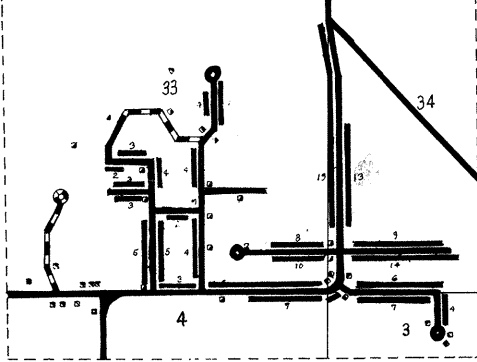

TARA HEIGHTS SEC. 33, 34 CROCKER TWP. T-80N, R-24W SCALE: 5 1/4 MILE

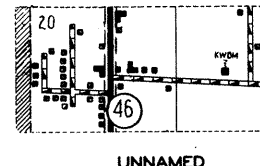

UNNAMED SEC. 20, 21 ALLEN TWP. T-78N, R-23W SCALE: 3 1/4 MILE

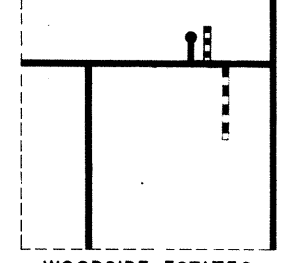

WOODSIDE ESTATES SEC. 11 SAYLOR TWP. T-79N, R-24W SCALE: 1 1/4 MILE

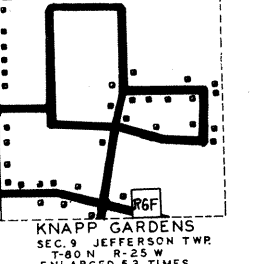

KNAPP GARDENS SEC. 9 JEFFERSON TWP. T-80N, R-25W ENLARGED 5.3 TIMES

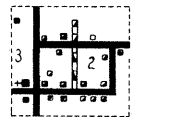

RISING SUN SEC. 3, 12 FOUR MILE TWP. T-78N, R-23W SCALE: 4 1/4 MILE

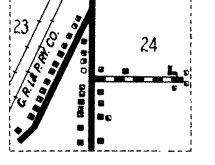

CASEBEER SEC. 23, 24 CLAY TWP. T-79N, R-23W SCALE: 2 1/2 MILE

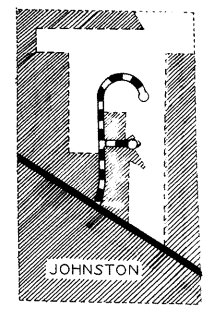

JOHNSTON SEC. 6 SAYLOR TWP. T-79N, R-24W ENLARGED 5.3 TIMES

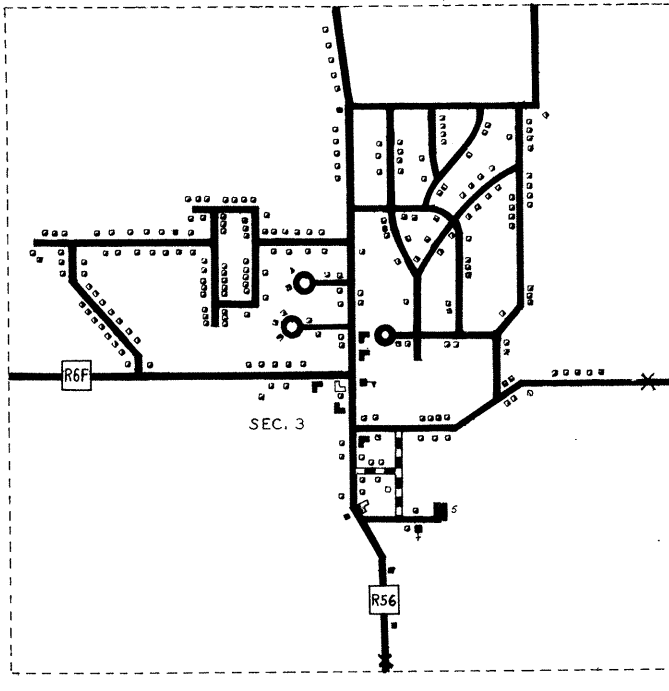

SAYLORVILLE SEC. 3, 1 SAYLOR TWP. T-79N, R-24W SCALE: 1 MILE

