

**IOWA BYWAYS™
PUBLICATION
BRAND USE POLICY**



**Iowa Department
of Transportation**

Local Systems Bureau
800 Lincoln Way
Ames, Iowa

REVISED
November 2024



IOWA BYWAYS™ BRAND GUIDELINES STANDARDS FOR PUBLICATION

Federal and state laws prohibit employment and/or public accommodation discrimination on the basis of age, color, creed, disability, gender identity, national origin, pregnancy, race, religion, sex, sexual orientation or veteran's status. If you believe you have been discriminated against, please contact the Iowa Civil Rights Commission at 800-457-4416 or Iowa Department of Transportation's affirmative action officer. If you need accommodations because of a disability to access the Iowa Department of Transportation's services, contact the agency's affirmative action officer at 515-239-1111.

Stuart Anderson
Transportation Development Division Director
Transportation Development Division

Nicole Moore
Bureau Director
Local Systems Bureau

Debra Arp
Grant Program Team Leader
Local Systems Bureau

Emily Whaley
Iowa Byways™ Program Manager
Local Systems Bureau

Revised November 2024
Iowa DOT Policy Manual Reference
Policy No. 000.08: VII. Permission for Use and Licensing

Table of Contents

IOWA BYWAYS™ PUBLICATION BRAND USE POLICY	0
INTRODUCTION	4
DEFINITIONS AND TERMS	6
WORD MARK	6
IOWA BYWAYS™ BRAND.....	6
SYSTEM-WIDE IDENTITY GRAPHIC	6
INDIVIDUAL BYWAY LOGO	6
WAYSHOWING SIGNAGE (Byway Guide Signs).....	6
Iowa Byways™ Brand System-Wide Identity	7
PROPER NOTICE:.....	7
PROPER USE:.....	7
PROPER ATTRIBUTION:.....	7
QUESTIONS:.....	7
Iowa Byways™ Brand System-Wide Identity.....	8
ORIGINAL ARTWORK.....	8
RESTRICTIONS.....	8
Figure 1: Iowa Byways™— System-wide Graphic Identity	9
Figure 2: Iowa Byways™— System-wide Graphic Identity Color	10
Figure 3: Iowa Byways™— System-wide Graphic Black and White Version	11
Figure 4: Iowa Byways™— System-wide Graphic Identity Proportions	12
Figure 5: Iowa Byways™— Individual Byway Graphic Identities	13
Figure 6: Individual Byway Graphic Identities Registration	14
Figure 7: Individual Byway Graphic Identities Logo Example A	15
Byway Logo Elements.....	15
Byways Logo Proportions.....	15
Figure 8: Individual Byway Graphic Identities Logo Example B	16
Western Skies Scenic Byway.....	16
THE WORD MARK.....	16
LOGO.....	16
Figure 9: Iowa Byways™ Brand for Wayshowing Signage	17
Figure 10: Iowa Byways™ Brand Sign Specifications	18
IOWA BYWAYS™ BRAND- APPENDIX A	19
Iowa Byways™ Trademark License Restricted Use Agreement	20

AGREEMENT FOR USE OF IOWA BYWAYS GRAPHIC IDENTITY	23
Iowa Byways™ Trademark License Restricted Use Agreement	24
IOWA BYWAYS™ BRAND- APPENDIX B.....	28
INDIVIDUAL BYWAY GRAPHIC IDENTITIES	28
Figure 11: Covered Bridges Scenic Byway Graphic Identity Specifications	29
Figure 12: Delaware Crossing Scenic Byway Graphic Identity Specifications	30
Figure 13: Driftless Area Scenic Byway Graphic Identity Specifications	31
Figure 14: Glacial Trail Scenic Byway Graphic Identity Specifications	32
Figure 15: Grant Wood Scenic Byway Graphic Identity Specifications	33
Figure 16: Historic Hills Scenic Byway Graphic Identity Specifications	34
Figure 17: Jefferson Highway Heritage Byway Graphic Identity Specifications	35
Figure 18: Great River Road National Scenic Byway Graphic Identity Specifications	36
Figure 19: Iowa Valley Scenic Byway Graphic Identity Specifications	37
Figure 20: Lincoln Highway Heritage Byway Graphic Identity Specifications	38
Figure 21: Loess Hills National Scenic Byway Graphic Identity Specifications	39
Figure 22: River Bluffs Scenic Byway Graphic Identity Specifications	40
Figure 23: Western Skies Scenic Byway Graphic Identity Specifications	41
Figure 24: White Pole Road Scenic Byway Graphic Identity Specifications	42
IOWA BYWAYS™ BRAND- APPENDIX C	41
References	

INTRODUCTION

This document describes the components developed to create a recognizable, consistent, and memorable graphic identity for the Iowa Department of Transportation's Scenic Byway Program, the Iowa Byways™ brand. The brand is ultimately the program's public identity intended to create awareness of the program and its benefits and to encourage and enhance the visitor's experience on Iowa's scenic byways. This document also outlines rules for the brand's proper use and application.

The Iowa Department of Transportation intends to further the vitality of byways in the state scenic byways program through consistent brand recognition and promotion.

To that end, individual byway organizations and the Byways of Iowa Foundation may enter into licensing and use agreements with the Department to ensure that any commercial benefits of using Iowa Byways™ brands will be directly available to support these state designated Iowa byways.

Iowa DOT provides Iowa Byways™ brand materials free to the public, including the Iowa Byways™ *Travel Guide*, rack cards and posters through a link on the Iowa Byways™ Program page here: <https://iowadot.gov/iowasbyways/>

Iowa DOT Policy Manual Reference

Policy No. 000.08: VII. Permission for Use and Licensing

The graphic identities for the individual byways in the Iowa Byways™ program were developed in an intentionally simple graphic style to be a recognizable and memorable graphic theme, descriptive of the character and experience of the byway, and as a safe and effective wayshowing tool when displayed on highway guide signs.

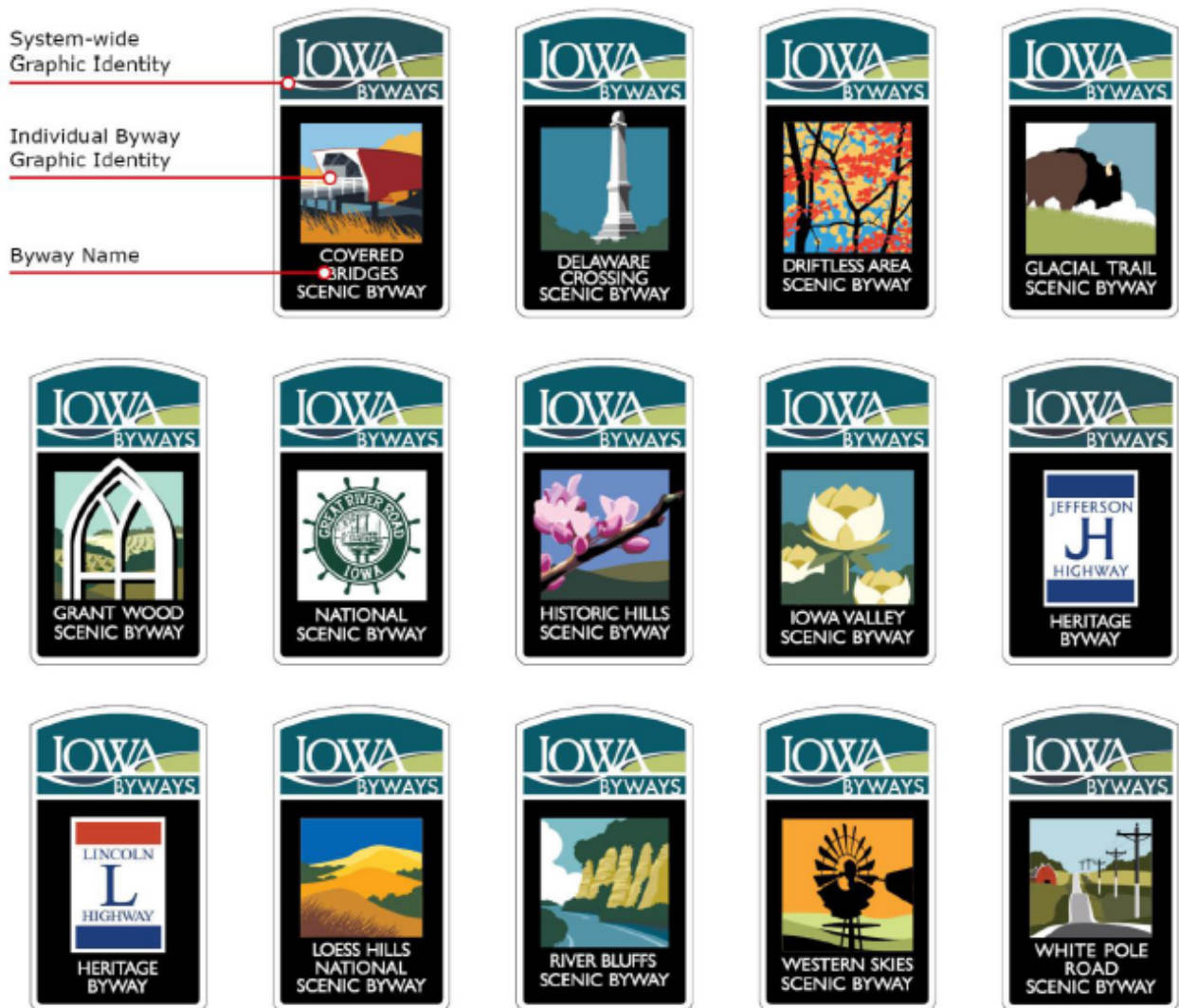

DEFINITIONS AND TERMS

WORD MARK

The word mark consists of the exact wording chosen to identify the subject. In this case, the words Iowa Byways™ is the official designation identifying the Iowa Department of Transportation’s scenic byway program. This wording is legally and exclusively affiliated with this program irrespective of punctuation, associated graphics, or typographic style. This is also true of the names of the 11 individual byways which make up the Iowa Byways™ program; for example; Western Skies Scenic Byway is the official word mark of the Western Skies Scenic Byway and is likewise protected under state law.

Iowa Byways™

**Western Skies
Scenic Byway**
(Word Marks)

IOWA BYWAYS™ BRAND

The Iowa Byways™ brand consists of the word mark, graphic design, and color palette developed to identify and create recognition for the Iowa Department of Transportation’s scenic byway program. The brand is designed to consistently identify the program across a range of media such as signage, brochures, and websites.



(System-wide Identity Graphic)

SYSTEM-WIDE IDENTITY GRAPHIC

The system-wide identity graphic is a stand-alone graphic that incorporates the word mark, graphic design and color palette and is the identity for the Iowa Byways™ program.

INDIVIDUAL BYWAY LOGO

Each of the 14 byways in the Iowa Byways™ program is identified with a unique graphic, in combination with a name, to create a logo. While unique logos have been developed for each byway, they share graphic and typographic characteristics designed to unite them as a family of logos within the Iowa Byways™ brand.



(Individual Byway Logo)

WAYSHOWING SIGNAGE (Byway Guide Signs)

Wayshowing signage describes byway guide signs designed to assist visitors in safely and efficiently finding their way along Iowa’s scenic byways. Wayshowing signage consists of a combination of the system-wide identity graphic and individual byway logo



(Wayshowing Signage)

Iowa Byways™ Brand System-Wide Identity

PROPER NOTICE:

A trademark symbol is required for all prominent uses of the mark (e.g., titles of documents, headlines, labels, packaging, marketing collateral, signage, Web site promotion, brochures, data sheets, news releases, advertising, etc.) except where space or style criteria prevent compliance with this requirement. A trademark symbol is required on the first use of the mark in any text or body copy, even though the symbol may have already been used in the headline or other prominent use: Iowa Byways™. The ™ indicates the trademark is protected and registered in Iowa with the Secretary of State. Wherever possible, the trademark notice should appear in superscript in a size smaller than the mark itself and without parentheses. Where such formatting is not available, however, place the appropriate letters in parentheses next to the mark.



PROPER USE:

The Iowa Byways™ trademark is an adjective (brand name) and should be followed by the generic term it describes (highway, route, corridor, roadway, etc.). Please follow these guidelines in using the trademark:

- Do not use the mark as a noun or verb.
- Do not pluralize the mark.
- Do not hyphenate the words in the mark.
- Keep the trademark distinct from other text, images or material.
- Do not alter, stretch, skew, edit, modify or combine the trademark with other marks.
- Adhere to the color schemes in attachments A and B.
- Do not render the trademark possessive through use of an apostrophe.
- Provide a proper trademark notice and attribution.

PROPER ATTRIBUTION:

When you use the Iowa DOT's trademark in any materials, please include a brief statement attributing ownership of the mark to the Iowa Department of Transportation. For example: The word mark Iowa Byways™ and Iowa Byways™ design mark are registered Iowa DOT trademarks.

QUESTIONS:

Questions about proper usage of the Byways mark should be directed to
Iowa Department of Transportation
Outreach & Development Bureau
800 Lincoln Way
Ames, IA 50010

Iowa Byways™ Brand System-Wide Identity

ORIGINAL ARTWORK

Original artwork should be obtained directly from the Iowa DOT.



RESTRICTIONS

YOU MAY NOT USE THE IOWA BYWAYS™ BRAND WORD MARK, SYSTEM-WIDE IDENTITY GRAPHIC, OR ANY OF THE INDIVIDUAL BYWAY WORD MARKS OR LOGOS:

- In, as or part of your own business name, product name, domain name or in the name of your service.
- To identify products or services that are not associated closely with the Iowa Byways™ program or any Individual Byway.
- In a manner likely to cause confusion.
- In a manner that directly or indirectly expresses or implies Iowa DOT sponsorship, affiliation, certification, approval, or endorsement in relation to your own activities, products and services that are separate from or unrelated to Iowa Byways or participating members of the Iowa Byways™ program.
- In connection with any obscene or pornographic materials; and your use of the mark may not be disparaging, defamatory or libelous to the Iowa DOT, any of its products or services, or any person or entity.
- In any manner that shortens or abbreviates the mark.
- As a slang term.

Figure 1: Iowa Byways™ — System-wide Graphic Identity

System-wide Graphic Identity

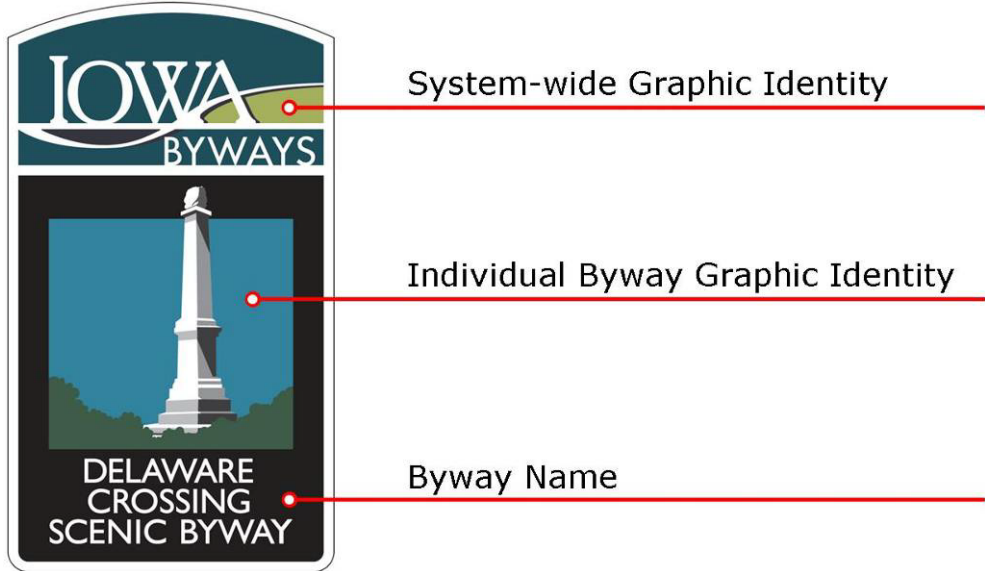

System wide Graphic identify in combination with individual byway graphic identity

The Iowa Byways™ system-wide graphic identity is single image that represents the comprehensive family of Iowa Byways™. It can be a stand-alone graphic for identifying and promoting the Iowa Byways™ program. It combines with individual byway graphic identities on highway guide signage. The system-wide identity graphic is an intentionally simple graphic style that is a recognizable and memorable graphic theme without competing with or dominating the individual byway graphic identity when displayed on wayshowing signage. The colors and curves in the graphic identity are an abstraction of the undulating Iowa landscape. These colors serve as the primary color palette for the Iowa Byways™ brand.

Figure 2: Iowa Byways™ — System-wide Graphic Identity Color

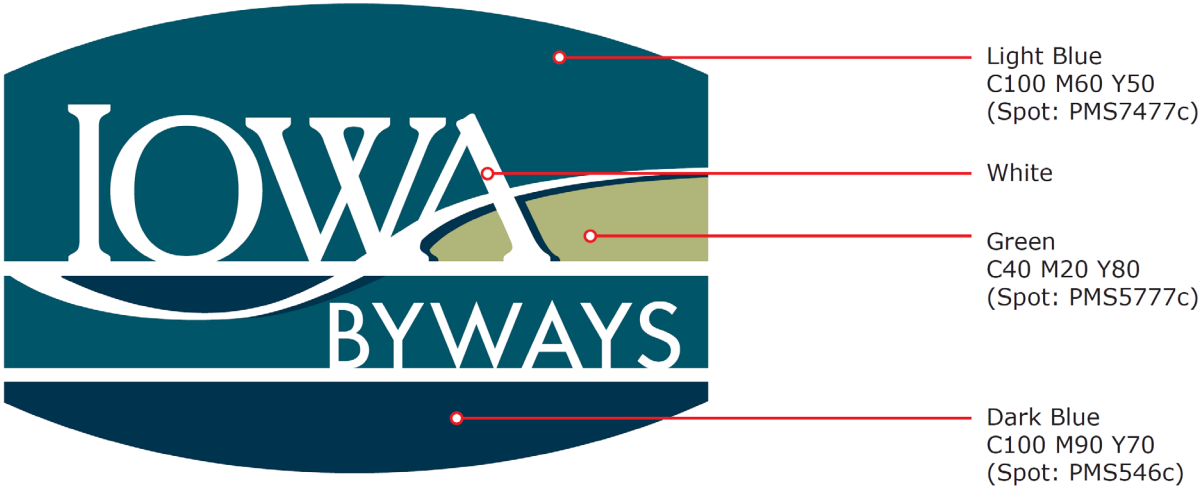

The typeface for “IOWA” is a derivation of Cheltenham BT set in all caps. The original typeface is manipulated to blend with abstract graphic representations of hills and valleys. Typeface for “BYWAYS” is Gill sans set in all caps.

Colors for the brand identity are Light Blue (C100 M60 Y50) or PMS equivalent, Dark Blue (C100 M90 Y70) or PMS equivalent, and green (C40 M20 Y80) or PMS equivalent.

Figure 3: Iowa Byways™ — System-wide Graphic Black and White Version

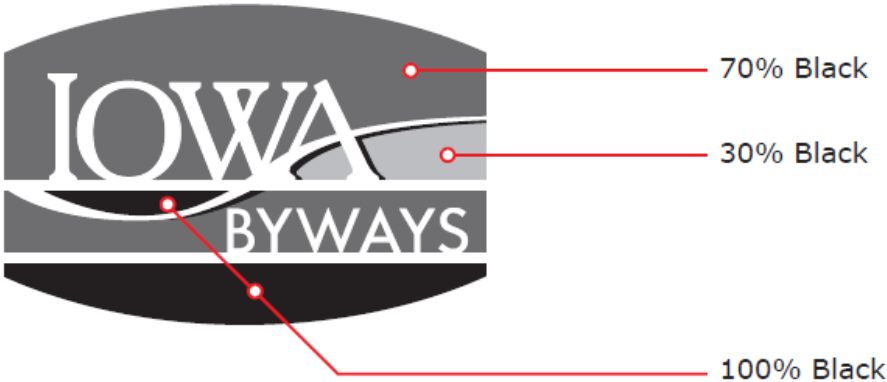

A black and white version consists of 70% black = light blue, 100% black = dark blue, and 30% black = green

Figure 4: Iowa Byways™ — System-wide Graphic Identity Proportions

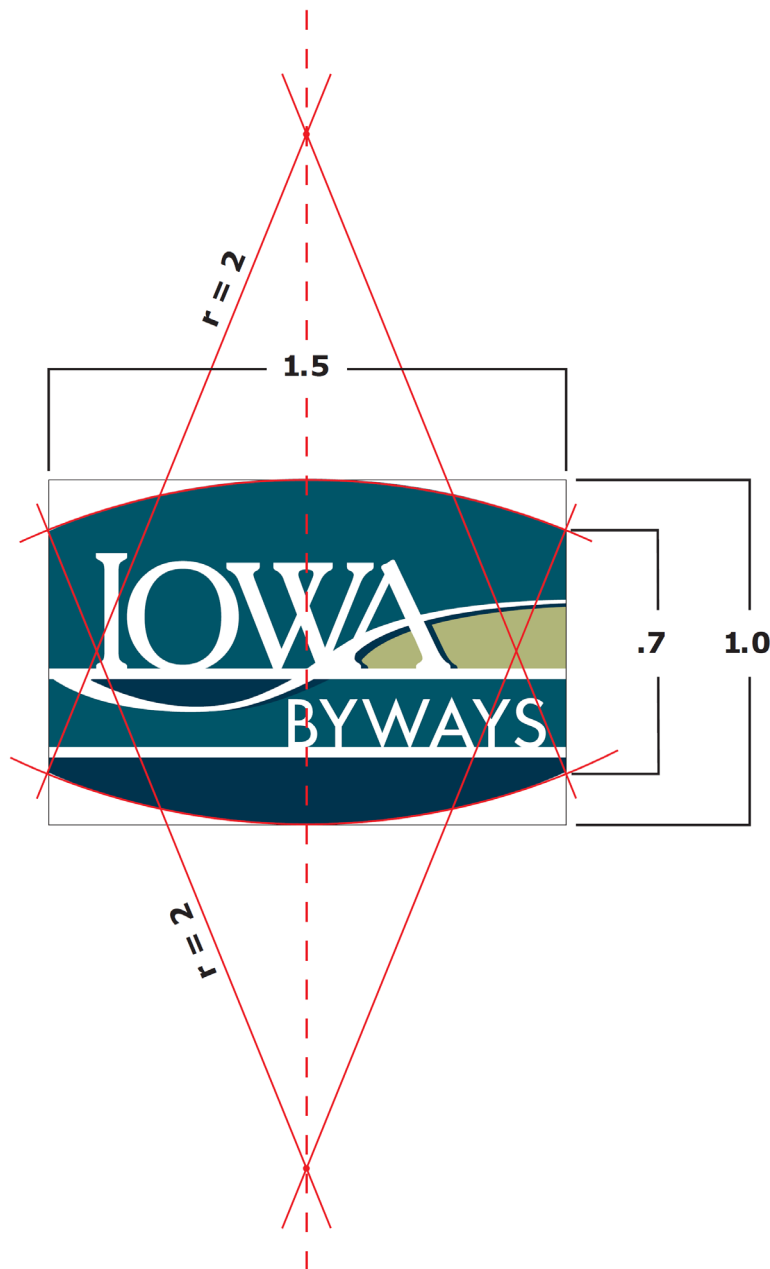

The proportion of the system-wide identity graphic is created in a ratio of 1.0 (height) to 1.5 (width).

Any enlargement or reduction of the graphic identity must maintain the ratio.

At a ratio of 1.0 to 1.5, the radii of the arcs comprising the top and bottom of the mark = 2.0.

FOR PRINT, DIGITAL, &
PROMOTIONAL
APPLICATIONS:

For printed media, the minimum size of the logo must not be less than 1/2" high.



Figure 5: Iowa Byways™ — Individual Byway Graphic Identities



The graphic identities for the individual byways in the Iowa Byways™ program were developed in an intentionally simple graphic style so as to be a recognizable and memorable graphic theme, descriptive of the character and experience of the byway, and as a safe and effective wayshowing tool when displayed on highway guide signs.

Figure 6: Individual Byway Graphic Identities Registration

Definitions and Trademark Registration:

Trademarks Available: (Exhibits page 10)

Trademark Description	Registration Number Class 101: Advertising & Business	Registration Number Class 105: Transportation & Storage
Iowa Byways™ System Wide Identity Graphic	5480TM-702187	5480TM-702204
Loess Hills National Scenic Byway	5480TM-702190	5480TM-702208
Delaware Crossing Scenic Byway	5480TM-702181	5480TM-702201
Driftless Area Scenic Byway	5480TM-702185	5480TM-702203
Glacial Trail Scenic Byway	5480TM-702180	5480TM-702200
Grant Wood Scenic Byway	5480TM-702198	5480TM-702218
Historic Hills Scenic Byway	5480TM-702197	5480TM-702216
Iowa Valley Scenic Byway	5480TM-702192	5480TM-702213
Lincoln Highway Heritage Byway	5480TM-702191	5480TM-702210
River Bluffs Scenic Byway	5480TM-702189	5480TM-702207
Western Skies Scenic Byway	5480TM-702188	5480TM-702205
Covered Bridges Scenic Byway	5480TM-682622	5480TM-682620
Jefferson Highway Heritage Byway	5480TM-682626	5480TM-682629
White Pole Road Scenic Byway	5480TM-682637	5480TM-682631
Iowa Great River Road National Scenic Byway	DOT use authorized by Iowa MRPC	
Iowa Great River Road Logo only <i>Iowa Mississippi River Parkway Commission</i>	DOT use authorized by Iowa MRPC	

Figure 7: Individual Byway Graphic Identities Logo Example A

Byway Logo Elements

Each Iowa Byways™ logo consists of three parts;

1. The black background;
2. The graphic;
3. The name of the byway.

All three parts comprise the entirety of the logo, the graphic and/or text may not be separated from the black background.

Byways Logo Proportions

The proportion of each logo is created in a ratio of width = $1w$, height = $1.25w$. Any enlargement or reduction of the logo must maintain the ratio.

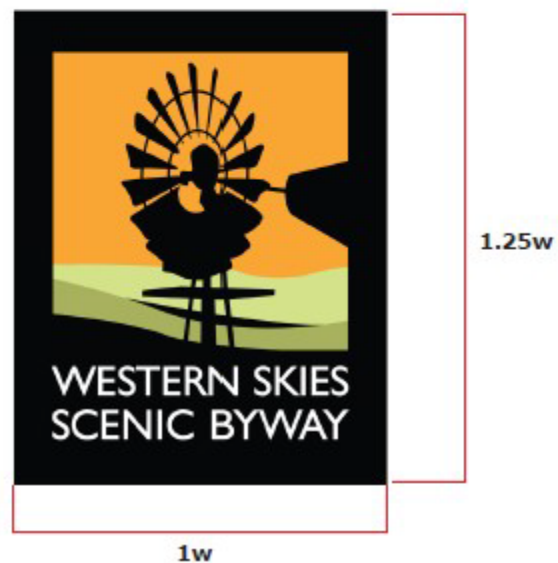
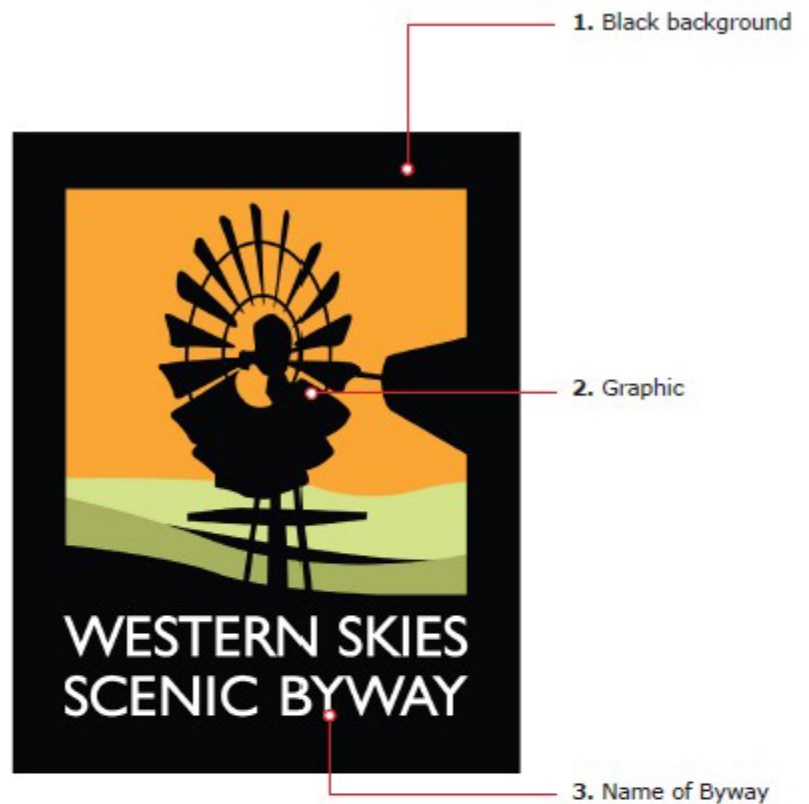

Figure 8: Individual Byway Graphic Identities Logo Example B

Western Skies Scenic Byway

THE WORD MARK

The word mark, WESTERN SKIES SCENIC BYWAY, consists of standard characters, without claim to any particular font, style, size or color.

LOGO

The Western Skies Scenic Byway logo was designed to represent the story and experience of the byway.

It is designed to be a stand-alone graphic for use in identifying and promoting the Western Skies Scenic Byway and the entirety of the Iowa Byways™ program.

It is also designed to be used in combination with the Iowa Byways™ system-wide identity graphic on roadway wayshowing signage.



Western Skies Scenic Byway logo (stand-alone)

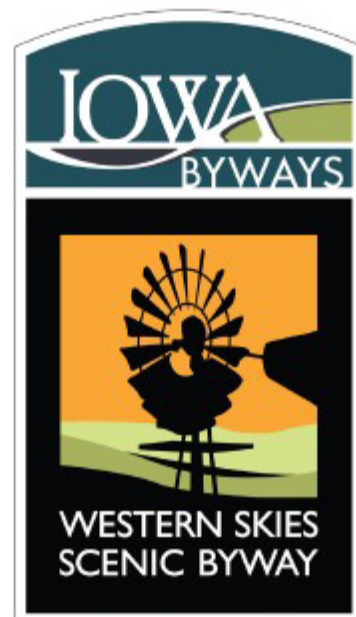

Western Skies Scenic Byway Logo in combination with Iowa Byways System-Wide Identity Graphic on wayshowing signage

Figure 9: Iowa Byways™ Brand for Wayshowing Signage

The mark consists of a variation of the system-wide identity graphic with a straight horizontal bottom in contrast to the arched bottom. The straight bottom is designed to accommodate the straight top of the individual byway logos that will appear below the system-wide identity graphic on roadway wayshowing signage.

The Iowa Department of Transportation will supply art to the signage fabricator.

Colors for roadway wayshowing signage are currently printed using 3M inkjet process on to SP4000 Provisional Spec Diamond Grade DG Cubed Series 4000 to be attached to die-cut aluminum substrate. (See page 3 of this document for colors assigned to the system-wide identity graphic on roadway wayshowing signage.)

The largest specified size for the individual byway logo is designed for roadway wayshowing signage and is 22.5" wide X 28.5" high. Use of the logo at sizes larger than the roadway sign dimension must be approved by the IA DOT.

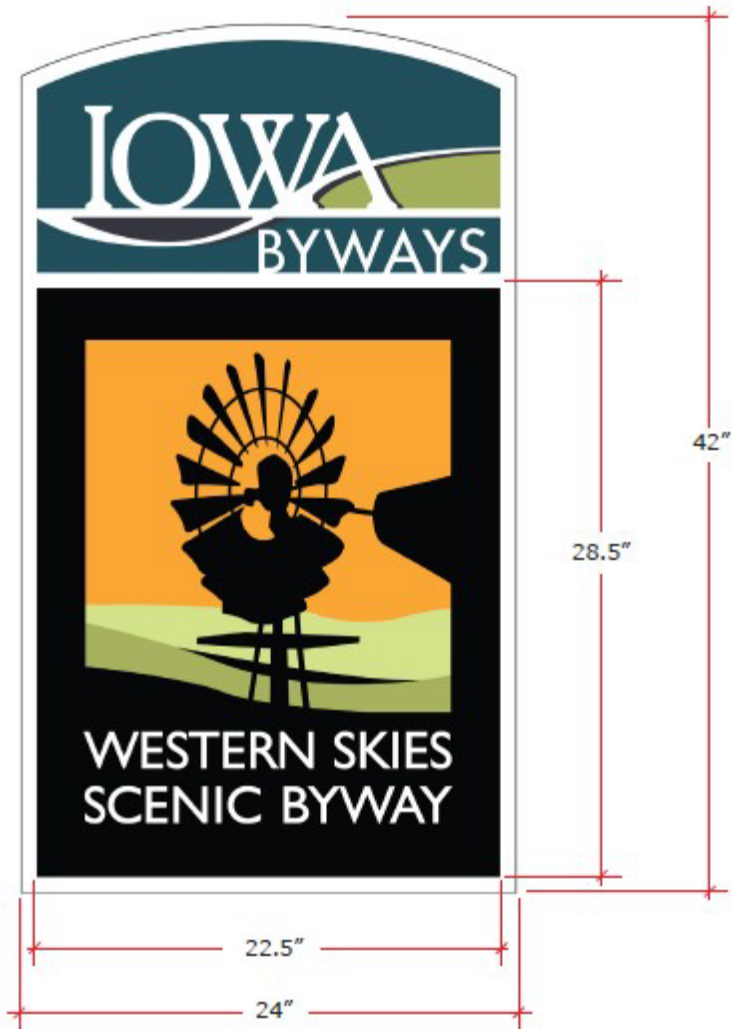

System-Wide Identity Graphic combined with Individual Byway Logo on wayshowing signage

Figure 10: Iowa Byways™ Brand Sign Specifications

Substrate sign blank dimension is rectangular 42" tall x 24" wide die-cut with an arc at the top.

Substrate is aluminum blank (.125) beginning in 2015.

There is a consistent 3/4" border around the sign. The arc of the system-wide identity graphic is consequently 3/4" shorter than the arc of the sign blade, $r = 28 \frac{1}{4}$ ".

All byway sign panels after December 2017 will utilize the same mounting hole placement for steel Post mounting.

- In the blue color block above "Iowa"
- In the black margin between the top logo and the art panel
- In the black margin below the bottom name lettering
- Dimensions are to the center of holes.
- Holes are 7/16" in diameter.

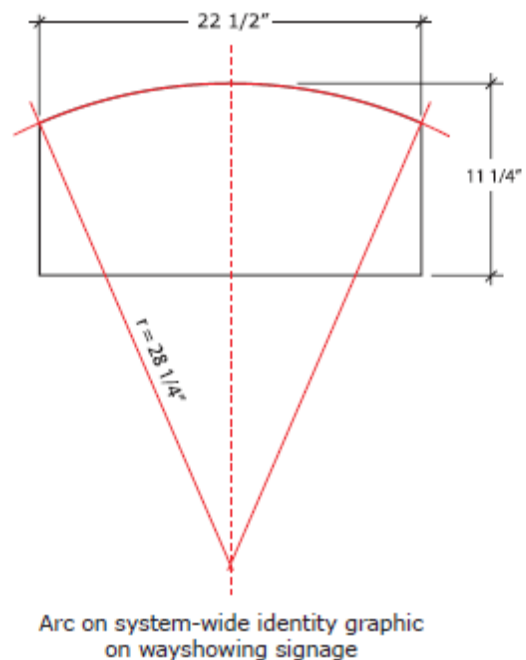
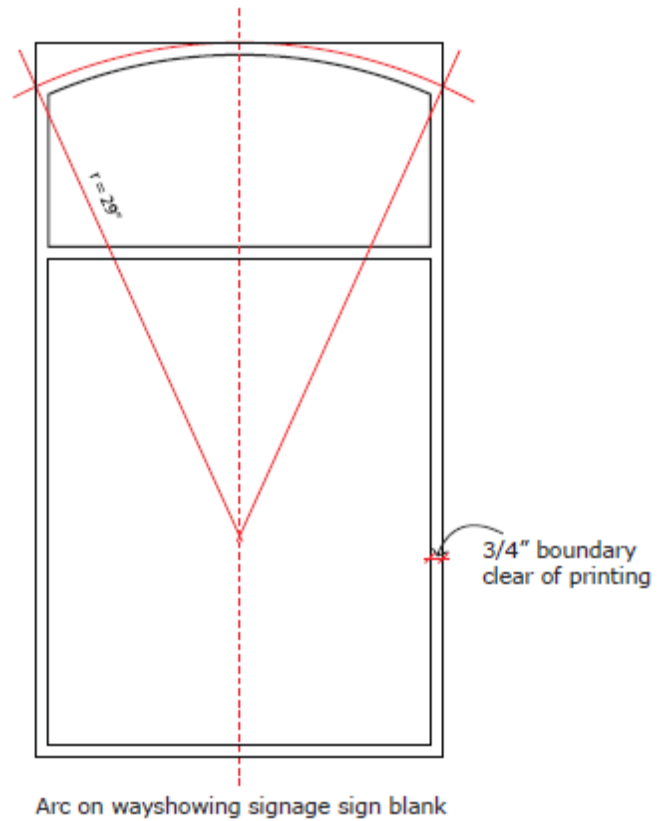
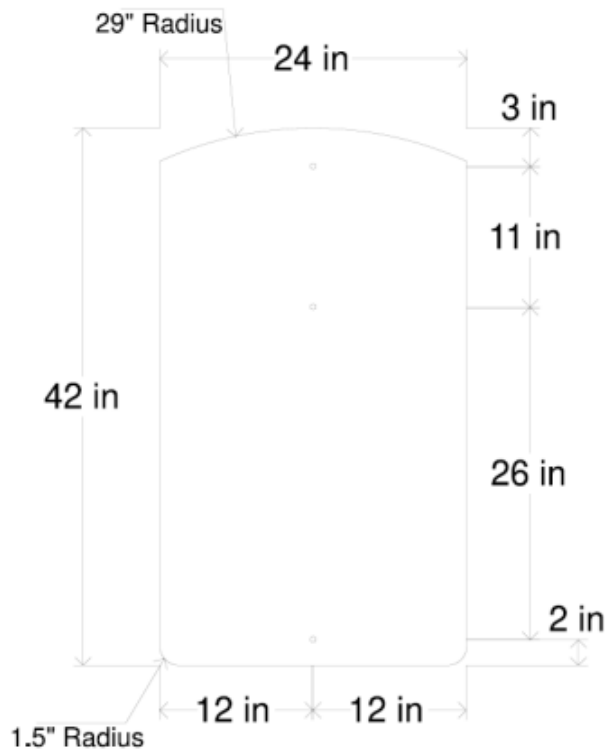

IOWA BYWAYS™ BRAND- Appendix A

AGREEMENT FOR USE OF IOWA BYWAYS™ GRAPHIC IDENTITY

Iowa Byways™ Trademark License Restricted Use Agreement

SAMPLE

Agreement Type:

Iowa Department of Transportation and an Iowa Byway Authorized Sponsor

This is a trademark license agreement between XXX Byway Non-profit (hereinafter referred to as licensee), Authorized sponsor and the Iowa Department of Transportation (hereinafter referred to as the Department).

All provisions included in this agreement are consistent with the Department Policy and Procedures Manual No. 000.08 and trademark registration filed with the Iowa Secretary of State. This agreement serves to grant a non-exclusive right to the licensee to use the licensed mark in the United States on and in connection with products or services acceptable to the Department.

Definitions and Trademark Registration:

Trademarks included in this release: (Exhibits attached)

Trademark Description	Registration Number Class 101: Advertising & Business	Registration Number Class 105: Transportation & Storage
Iowa Byways System Wide Identity Graphic	5480TM-702187	5480TM-702204
Loess Hills National Scenic Byway	5480TM-702190	5480TM-702208
Delaware Crossing Scenic Byway	5480TM-702181	5480TM-702201
Driftless Area Scenic Byway	5480TM-702185	5480TM-702203
Glacial Trail Scenic Byway	5480TM-702180	5480TM-702200
Grant Wood Scenic Byway	5480TM-702198	5480TM-702218
Historic Hills Scenic Byway	5480TM-702197	5480TM-702216
Iowa Valley Scenic Byway	5480TM-702192	5480TM-702213
Lincoln Highway Heritage Byway	5480TM-702191	5480TM-702210
River Bluffs Scenic Byway	5480TM-702189	5480TM-702207
Western Skies Scenic Byway	5480TM-702188	5480TM-702205
Covered Bridges Scenic Byway	5480TM-682622	5480TM-682620
Jefferson Highway Heritage Byway	5480TM-682626	5480TM-682629
White Pole Road Scenic Byway	5480TM-682637	5480TM-682631
Iowa Great River Road National Scenic Byway	DOT use authorized by Iowa MRPC	
Iowa Great River Road Logo only <i>Iowa Mississippi River Parkway Commission</i>	DOT use authorized by Iowa MRPC	

Description of use permitted by this agreement

The licensee has committed to utilizing the Iowa Byways™ and *BYWAY NAME*™ brands solely for purposes of supporting all Iowa Byways and the *BYWAY NAME* Byway.

The licensee shall provide the Department with product specifications and a specimen or prototype prior to production or other use. The Department shall review the specifications and specimens and provide the licensee written notification regarding conformance with the Department's standards for quality and acceptable use. It is preferred that the byway word mark with ™ and www.iowabyways.org web site be included on commercial products whenever practicable.

License Restrictions and Requirements

The licensee acknowledges the following license restrictions and requirements:

1. The Department retains all rights, title and interest in the mark;
2. The Department explicitly prohibits use of the mark for:
 - a. Alcoholic beverages (distilled alcohol liquors, wines and malt liquors)
 - b. Tobacco or tobacco-related paraphernalia
 - c. Controlled substances
 - d. Items that are excessively violent
 - e. Items that are inherently dangerous or carry high product liability risks (firearms, explosives, fuels and paints)
 - f. Items that are obscene, pornographic, disparaging or sexually suggestive
 - g. Items that would tend to lower the reputation or degrade the goodwill of the Department
 - h. Items that are religious
 - i. Items that are unlawful
 - j. Items related to gambling or other games of chance
 - k. Items that are otherwise in poor taste;
3. Reproductions of the mark must be from a digital master provided by the Department;
4. Altering the image(s) is prohibited;
5. The licensee is prohibited from assigning, transferring or sublicensing the agreement in any manner without the Department's written consent.
6. The licensee is wholly responsible for all products it manufactures or sells or services it provides and must indemnify and hold harmless the Department, its employees and agents for any liability, loss, damage, cost or expense attributable to any of licensee's products bearing the Department's marks.

Royalty Fees, Payments and Reporting

The licensee shall submit quarterly reports stating the donations collected under this program for that period. Profit earned will be managed by XXX Byway Non-profit.

The Department will not receive royalties or other income from this licensing agreement. The XXX Byway Non-profit use of income will benefit the Iowa Byways™ and the *BYWAY NAME* Byway as intended by the creation and registration of these Iowa Byways™ trademarks.

The Department shall retain the right to examine the licensee's accounts and records related to the licensed products or services to determine the accuracy of the statements submitted by licensee. If an examination reveals underpayment by more than 5 percent of the total due, the licensee shall bear the costs of the audit.

Term of agreement, termination and renewal option.

This agreement between the IA DOT and the signee exists in perpetuity. The Department reserves the right to terminate the agreement or revise it upon changes in the byway status or the state byway program. The agreement may be amended by documentation of agreement by all signatory parties.

Notices and other communications.

Written notices and communications shall be delivered by hard copy or by e-mail to designated individuals representing each of the signatory parties.

Whereas the Iowa Department of Transportation has adopted, registered and is using the "Iowa Byways" name and collection of logos as trademarks; and

AGREEMENT FOR USE OF IOWA BYWAYS™ GRAPHIC IDENTITY

AGREEMENT FOR USE OF IOWA BYWAYS™ GRAPHIC IDENTITY
AND XXXXXXXX SCENIC BYWAY LOGO

The Iowa Department of Transportation (IA DOT) has registered the Iowa Byways™ word mark and graphic identity and the XXXXXX Scenic Byway word mark and logo with the State of Iowa and maintains exclusive rights to their use.

Registration number: _____

This agreement extends the use of the Iowa Byways™ graphic identity and the _____ *Scenic Byway* logo to the signee for the purposes of promotional use related to the byway.

This agreement between the IA DOT and the signee exists *in perpetuity* with the following provisions:

Any use of the Iowa Byways™ graphic identity and the _____ Byway logo must meet the standards and requirements described in the Brand Guidelines.

Any use not included in the Brand Guidelines must first be submitted to the IA DOT and written approval obtained. Any use for sale requires a license use application and agreement executed by the Iowa DOT.

Any unauthorized use deemed inappropriate by the IA DOT may result in suspension of this agreement.

The IA DOT Systems Planning Bureau reserves the right to modify, suspend, or revoke this agreement if the above provisions are not met. Written notification of any change to this agreement will be provided to the signee(s).

Byway entity

Iowa Department of Transportation

Date

Date

Iowa Byways™ Trademark License Restricted Use Agreement

SAMPLE

Agreement Type:

Iowa Department of Transportation and an Iowa Byway™ Authorized Sponsor

This is a trademark license agreement between XXX Byway Non-profit (hereinafter referred to as licensee), Authorized sponsor and the Iowa Department of Transportation (hereinafter referred to as the Department).

All provisions included in this agreement are consistent with the Department Policy and Procedures Manual No. 000.08 and trademark registration filed with the Iowa Secretary of State. This agreement serves to grant a non-exclusive right to the licensee to use the licensed mark in the United States on and in connection with products or services acceptable to the Department.

Definitions and Trademark Registration:

Trademarks included in this release: (Exhibits attached)

Trademark Description	Registration Number Class 101: Advertising & Business	Registration Number Class 105: Transportation & Storage
Iowa Byways System Wide Identity Graphic	5480TM-702187	5480TM-702204
Loess Hills National Scenic Byway	5480TM-702190	5480TM-702208
Delaware Crossing Scenic Byway	5480TM-702181	5480TM-702201
Driftless Area Scenic Byway	5480TM-702185	5480TM-702203
Glacial Trail Scenic Byway	5480TM-702180	5480TM-702200
Grant Wood Scenic Byway	5480TM-702198	5480TM-702218
Historic Hills Scenic Byway	5480TM-702197	5480TM-702216
Iowa Valley Scenic Byway	5480TM-702192	5480TM-702213
Lincoln Highway Heritage Byway	5480TM-702191	5480TM-702210
River Bluffs Scenic Byway	5480TM-702189	5480TM-702207
Western Skies Scenic Byway	5480TM-702188	5480TM-702205
Covered Bridges Scenic Byway	5480TM-682622	5480TM-682620
Jefferson Highway Heritage Byway	5480TM-682626	5480TM-682629
White Pole Road Scenic Byway	5480TM-682637	5480TM-682631
Iowa Great River Road National Scenic Byway	DOT use authorized by Iowa MRPC	
Iowa Great River Road Logo only <i>Iowa Mississippi River Parkway Commission</i>	DOT use authorized by Iowa MRPC	

Description of use permitted by this agreement

The licensee has committed to utilizing the Iowa Byways™ and *BYWAY NAME*™ brands solely for purposes of supporting all Iowa Byways and the *BYWAY NAME* Scenic Byway.

The licensee shall provide the Department with product specifications and a specimen or prototype prior to production or other use. The Department shall review the specifications and specimens and provide the licensee written notification regarding conformance with the Department's standards for quality and acceptable use. It is preferred that the byway word mark with ™ and www.iowabyways.org web site be included on commercial products whenever practicable.

License Restrictions and Requirements

The licensee acknowledges the following license restrictions and requirements:

1. The Department retains all rights, title and interest in the mark;
2. The Department explicitly prohibits use of the mark for:
 - a. Alcoholic beverages (distilled alcohol liquors, wines and malt liquors)
 - b. Tobacco or tobacco-related paraphernalia
 - c. Controlled substances
 - d. Items that are excessively violent
 - e. Items that are inherently dangerous or carry high product liability risks (firearms, explosives, fuels and paints)
 - f. Items that are obscene, pornographic, disparaging or sexually suggestive
 - g. Items that would tend to lower the reputation or degrade the goodwill of the Department
 - h. Items that are religious
 - i. Items that are unlawful
 - j. Items related to gambling or other games of chance
 - k. Items that are otherwise in poor taste;
3. Reproductions of the mark must be from a digital master provided by the Department;
4. Altering the image(s) is prohibited;
5. The licensee is prohibited from assigning, transferring or sublicensing the agreement in any manner without the Department's written consent.
6. The licensee is wholly responsible for all products it manufactures or sells or services it provides and must indemnify and hold harmless the Department, its - employees and agents for any liability, loss, damage, cost or expense attributable to any of licensee's products bearing the Department's marks.

Royalty Fees, Payments and Reporting

The licensee shall submit quarterly reports stating the donations collected under this program for that period. Profit earned will be managed by Northeast Iowa Resource Development and Conservation.

The Department will not receive royalties or other income from this licensing agreement. The XXX Byway Non-profit use of income will benefit the Iowa Byways and the *BYWAY NAME* Byway as intended by the creation and registration of these Iowa Byways trademarks.

The Department shall retain the right to examine the licensee's accounts and records related to the licensed products or services to determine the accuracy of the statements submitted by licensee. If an examination reveals underpayment by more than 5 percent of the total due, the licensee shall bear the costs of the audit.

Term of agreement, termination and renewal option.

This agreement between IDOT and the signee exists in perpetuity. The Department reserves the right to terminate the agreement or revise it upon changes in the byway status or the state byway program. The agreement may be amended by documentation of agreement by all signatory parties.

Notices and other communications.

Written notices and communications shall be delivered by hard copy or by e-mail to designated individuals representing each of the signatory parties.

Whereas the Iowa Department of Transportation has adopted, registered and is using the "Iowa Byways™" name and collection of logos as trademarks; and

IN WITNESS WHEREOF, each of the parties hereto has executed this agreement as of the date shown opposite its signature below.

BYWAY ORGANIZATION
ADDRESS

Signed:

Name: _____

Title: _____ Date: _____

Witnessed:

Name: _____

Title: _____ Date: _____

IOWA DEPARTMENT OF TRANSPORTATION
800 Lincoln Way, Ames, Iowa 50010

Signed:

Andrea Henry

Director, Strategic Communications Date: _____

Witnessed:

Name: _____

Title: _____ Date: _____

**IOWA BYWAYS™ BRAND-
Appendix B**

Individual Byway Graphic Identities

Figure 11: Sign Specifications Covered Bridges Scenic Byway Graphic Identity Specifications

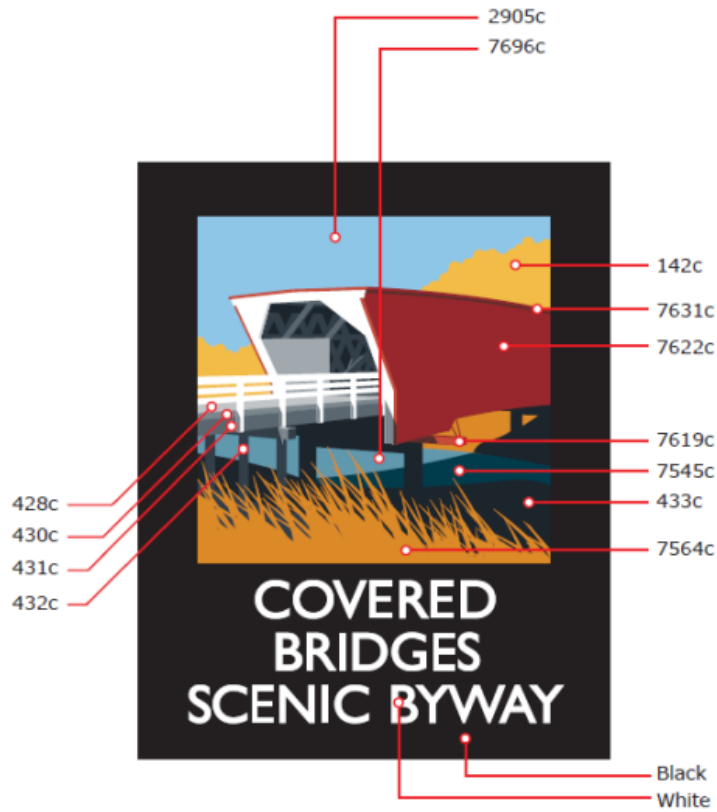

The typeface for "COVERED BRIDGES SCENIC BYWAY" is Gill Sans set in all caps.

Colors for the Delaware Crossing graphic identity are carried in the graphic above.

Figure 12: Delaware Crossing Scenic Byway Graphic Identity Specifications

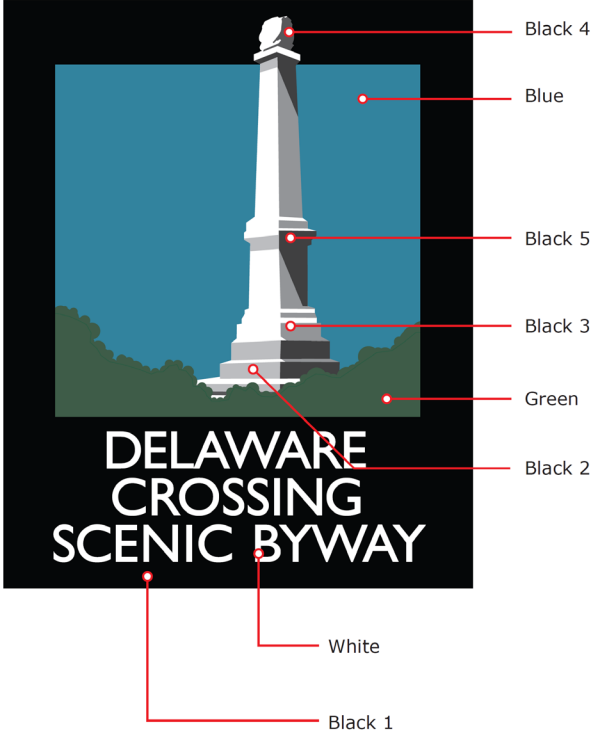

The typeface for “DELAWARE CROSSING SCENIC BYWAY” is Gill Sans set in all caps. Colors for the Delaware Crossing graphic identity:

- Blue: C80 M40 Y30
- Green: C90 M70 Y90
- Black 1: 100%
- Black 2: 30%
- Black 3: 50%
- Black 4: 80%
- Black 5: 90%
- White

Figure 13: Driftless Area Scenic Byway Graphic Identity Specifications

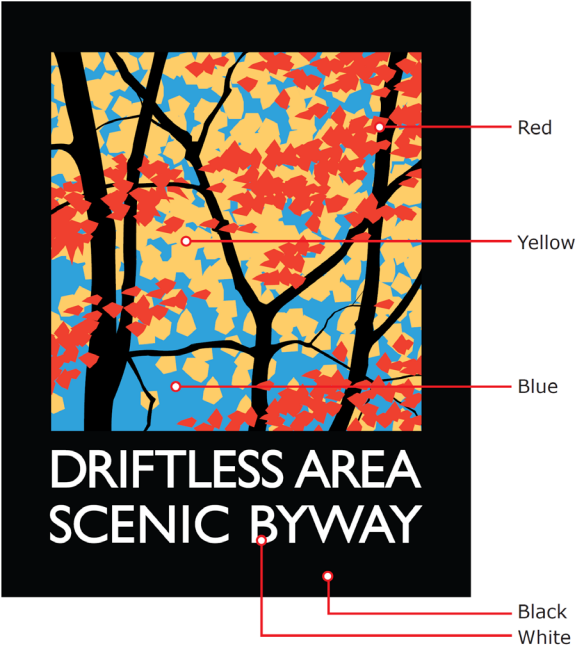

The typeface for “DRIFTLESS AREA SCENIC BYWAY” is Gill Sans set in all caps. Colors for the Driftless Area graphic identity:

- Red: M90 Y90
- Yellow: M20 Y70
- Blue: C70 M20
- Black
- White

Figure 14: Glacial Trail Scenic Byway Graphic Identity Specifications

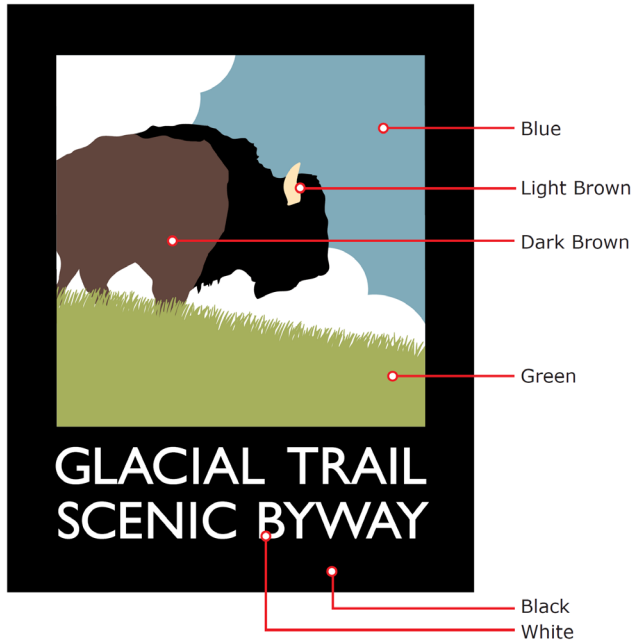

The typeface for “GLACIAL TRAIL SCENIC BYWAY” is Gill Sans set in all caps. Colors for the Glacial Trail graphic identity:

Blue: C50 M20 Y20

Green: C40 M20 Y80

Light Brown: M10 Y30

Dark Brown: C80 M90 Y100

Black

White

Figure 15: Grant Wood Scenic Byway Graphic Identity Specifications

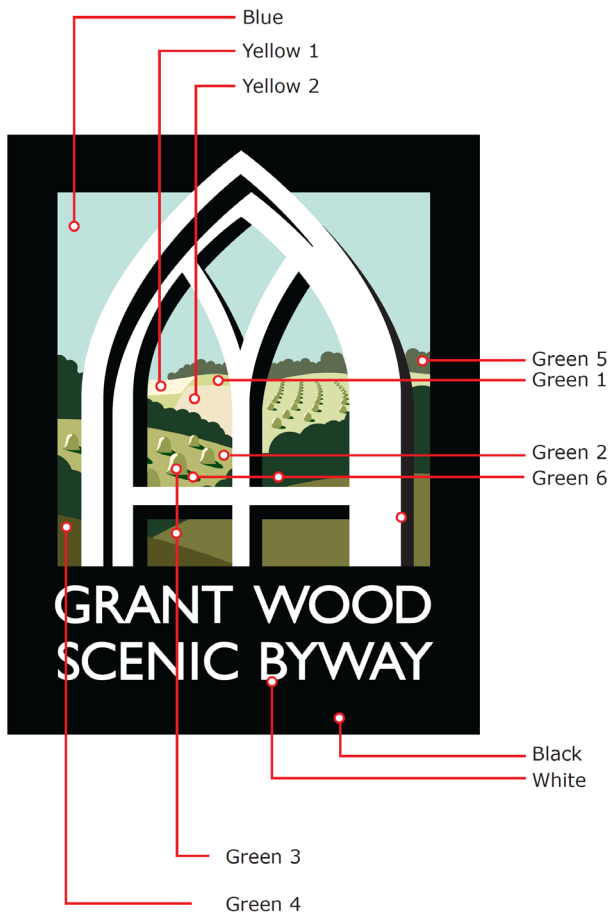

The typeface for “GRANT WOOD SCENIC BYWAY” is Gill Sans set in all caps. Colors for the Grant Wood graphic identity:

Blue: C30 Y20

Yellow 1: Y10

Yellow 2: Y20

Green 1: C20 Y50

Green 2: C30 M20 Y70

Green 3: C60 M50 Y100

Green 4: C80 M70 Y100

Green 5: C70 M50 Y80

Green 6: C100 M80 Y100

Black

White

Figure 16: Historic Hills Scenic Byway Graphic Identity Specifications

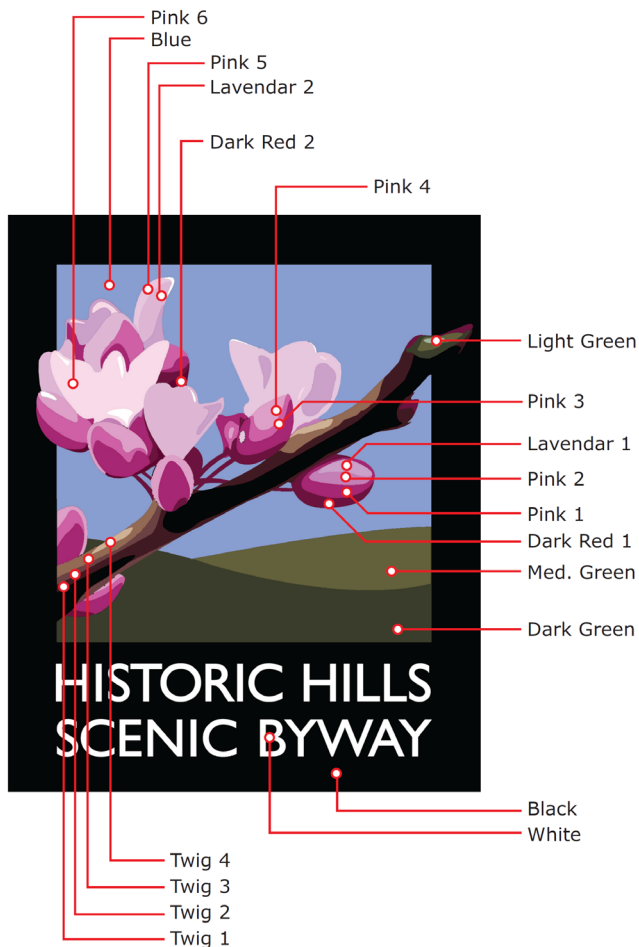

The typeface for “HISTORIC HILLS SCENIC BYWAY” is Gill Sans set in all caps. Colors for the Historic Hills graphic identity:

Blue: C60 M40

Light Green: C10 Y20

Medium Green: C70 M60 Y90

Dark Green: C100 M90 Y100

Twig 1: C90 M100 Y100

Twig 2: C70 M90 Y80

Twig 3: C20 M40 Y60

Twig 4: M10 Y20

Pink 1: C40 M100 Y30

Pink 2: C20 M60

Pink 3: C20 M80

Pink 4: M40

Pink 5: M20

Pink 6: M20

Lavendar 1: C20 M40

Lavendar 2: C10 M30Dark

Red 1: C60 M100 Y90Dark

Red 2: C70 M100 Y90

Black

White

Figure 17: Jefferson Highway Heritage Byway Graphic Identity Specifications

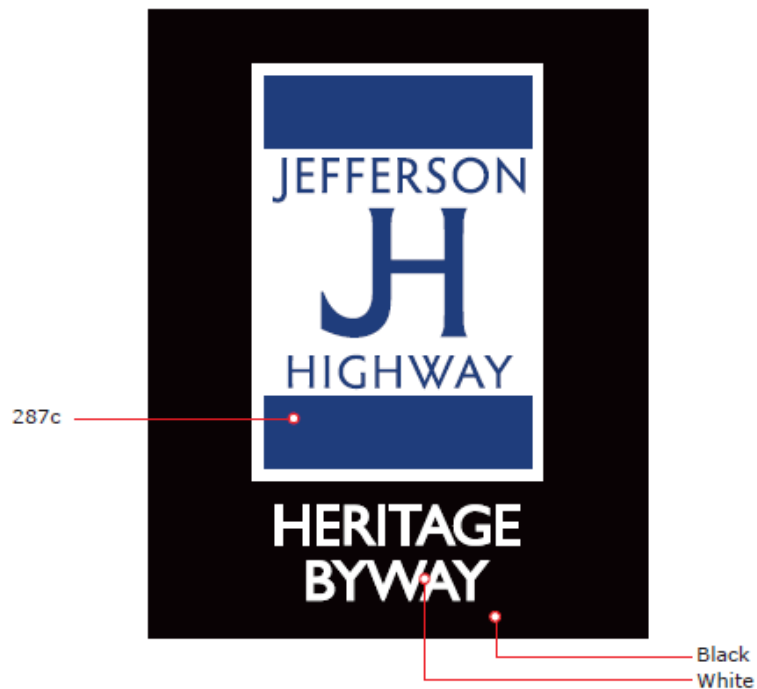

The typeface for “JEFFERSON HIGHWAY HERITAGE BYWAY” is Gill Sans set in all caps.

Colors for the Jefferson Highway graphic identity:

A black and white/grayscale version is available for use in non-color applications

Figure 18: Great River Road National Scenic Byway Graphic Identity Specifications



The typeface for “GREAT RIVER ROAD IOWA” is UNKNOWN distressed font set in all caps.

Colors for the Iowa Great River Road National Scenic Byway graphic identity:

Green: C90 M40 Y91 K43

White

Figure 19: Iowa Valley Scenic Byway Graphic Identity Specifications

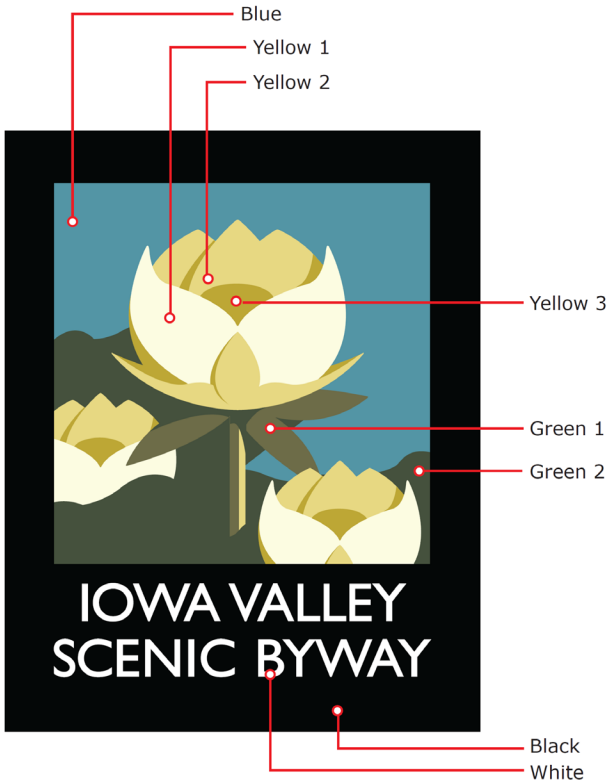

The typeface for “IOWA VALLEY SCENIC BYWAY” is Gill Sans set in all caps. Colors for the Iowa Valley graphic identity:

- Blue: C70 M30 Y30
- Yellow 1: Y10
- Yellow 2: C10 M10 Y60
- Yellow 3: C30 M30 Y100
- Green 1: C60 M40 Y80
- Green 2: C90 M70 Y90
- Black
- White

Figure 20: Lincoln Highway Heritage Byway Graphic Identity Specifications

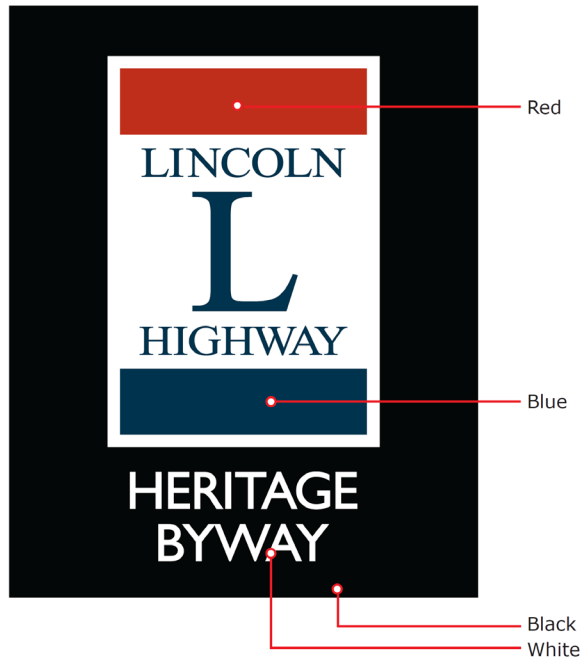

The typeface for “LINCOLN HIGHWAY HERITAGE BYWAY” is Gill Sans set in all caps. Colors for the Lincoln Highway graphic identity:

Red: M100 Y100 C20

Blue: C100 M70 Y20

Black

White

NOTE: These typeface and color specifications apply when used for LOOP identification and guide signs.

Figure 21: Loess Hills National Scenic Byway Graphic Identity Specifications

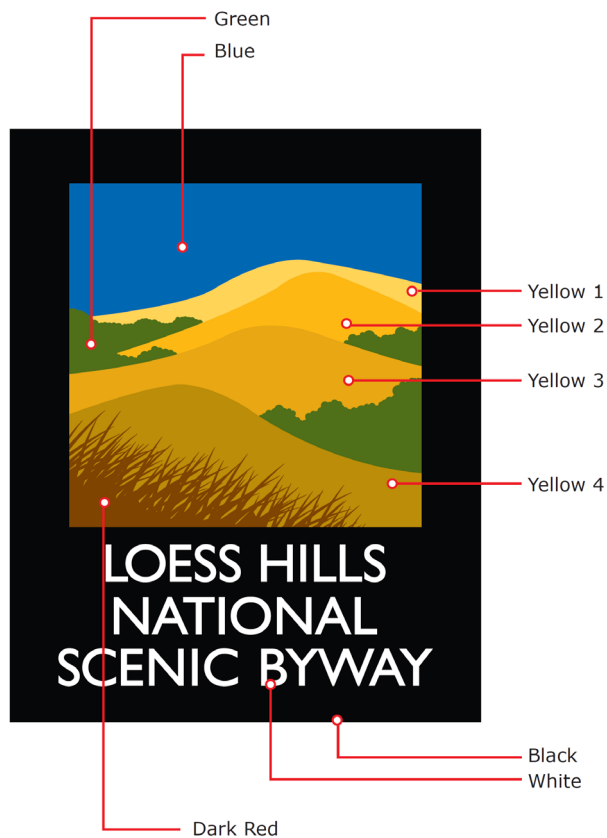

The typeface for "LOESS HILLS NATIONAL SCENIC BYWAY" is Gill Sans set in all caps. Colors for the Loess Hills graphic identity:

Blue: C100 M60
Green: C90 M70 Y100
Yellow 1: M10 Y70
Yellow 2: M20 Y90
Yellow 3: M40 Y100
Yellow 4: C20 M50 Y100
Dark Red: C70 M90 Y100
Black
White

NOTE: These typeface and color specifications apply when used for LOOP identification and guide signs.

Figure 22: River Bluffs Scenic Byway Graphic Identity Specifications

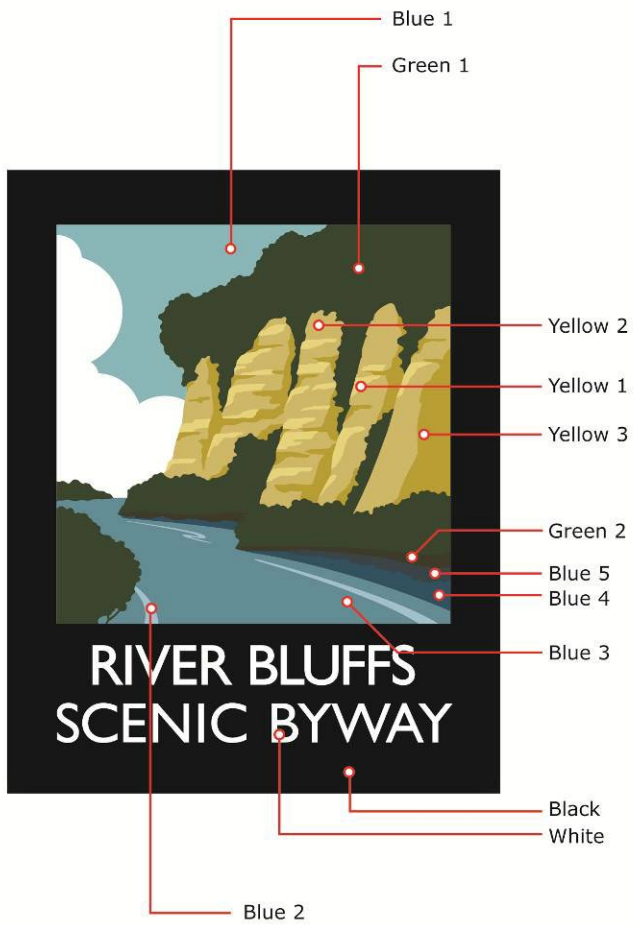

The typeface for “RIVER BLUFFS SCENIC BYWAY” is Gill Sans set in all caps. Colors for the River Bluffs graphic identity:

- Blue 1: C50 M10 Y20
- Blue 2: C40 M10 Y10
- Blue 3: C70 M30 Y30
- Blue 4: C100 M70 Y50
- Blue 5: C100 M80 Y70
- Green 1: C100 M80 Y100
- Green 2: C100 M90 Y100
- Yellow 1: C10 M10 Y60
- Yellow 2: C20 M20 Y70
- Yellow 3: C30 M30 Y100
- Black
- White

Figure 23: Western Skies Scenic Byway Graphic Identity Specifications

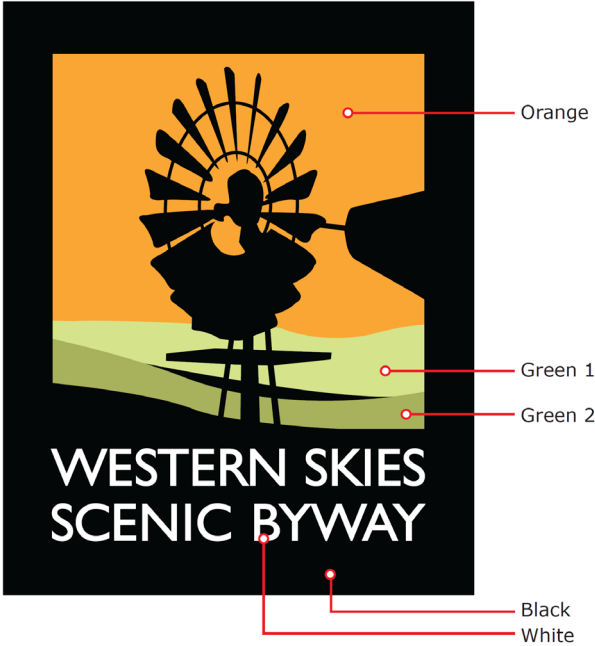

The typeface for “WESTERN SKIES SCENIC BYWAY” is Gill Sans set in all caps. Colors for the Western Skies graphic identity:

- Orange: M40 Y90
- Green 1: C20 Y60
- Green 2: C40 M20 Y80
- Black
- White

Figure 24: White Pole Road Scenic Byway Graphic Identity Specifications

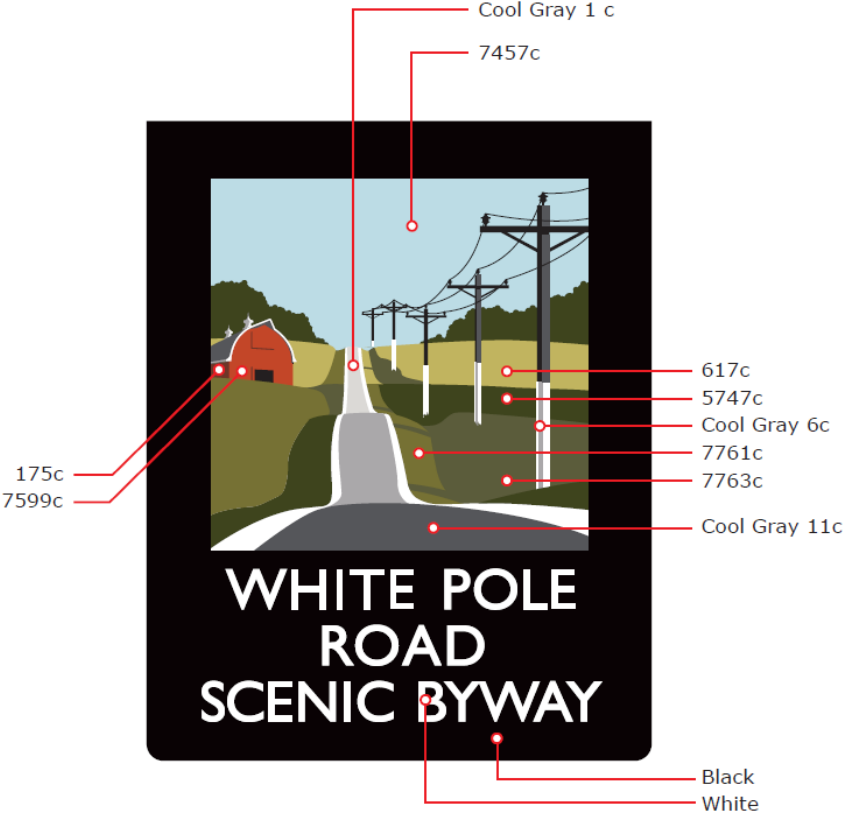

The typeface for “WHITE POLE ROAD SCENIC BYWAY” is Gill Sans set in all caps. A black and white grayscale version is available for use in non-color applications.

IOWA BYWAYS™ BRAND- APPENDIX C

Iowa DOT Policy Manual Reference

Policy No. 000.08

VII. Permission for Use and Licensing

D. Terms of licensing agreement. A standard, restricted-use agreement for licensing a DOT mark is available from General Counsel. Any revisions to the standard agreement language require General Counsel approval of form and legality of content. The following summarizes the provisions to be included in the standard agreement:

Parties to agreement. Names of the Department and the other party(ies) to the agreement.

Definitions: Terms applicable to the agreement

License grant. The grant of a non-exclusive right to the licensee to use the licensed mark in the United States on and in connection with products or services acceptable to the Iowa Department of Transportation.

License restrictions. The limitations or restrictions on use of the mark. These include:

- 1) an acknowledgement that the Department retains all rights, title and interest in the mark;
- 2) a description of unacceptable uses;
- 3) a requirement that reproductions of the mark must be from a digital master provided by the Department;
- 4) a prohibition on altering this image;
- 5) a description of the products or services on which the mark may be applied; and
- 6) how the mark may be used in advertising, marketing and promotional materials.

Conveyances. A provision prohibiting the licensee from assigning, transferring or sublicensing the agreement in any manner without the Department's written consent.

Royalty fees and payments. How royalty fees are calculated and paid. Fees may consist of a flat license issuance fee, paid at the time the agreement is executed; a continuing royalty on all licensed products sold or produced; a minimum annual royalty; or royalty fees on video, print and Web advertising.

Royalty exemptions. What royalty exemptions are and are not granted. Royalty exemptions will be granted for: 1) goods or services purchased by the DOT for internal consumption; 2) goods manufactured or purchased by the DOT that promote the DOT and its programs; and 3) bona fide fundraisers that are organized by DOT employees and that have been approved by the Director of Transportation.

Quarterly reports. A provision requiring the licensee to submit quarterly reports stating the total sales of all licensed products for that period and remit at that time the amount of royalties due from those sales.

Right to audit licensee. The Department's right to examine the licensee's accounts and records related to the licensed products or services to determine the accuracy of the statements submitted by licensee. Also, a provision stating that if an examination reveals underpayment by more than 5 percent of the total due, the licensee shall bear the costs of the audit.

Approval of specimen. A provision requiring the licensee to provide to the Department product specifications and a specimen/prototype prior to production or other use. The Department shall review the specifications and specimens and provide the licensee written notification regarding conformance with the Department's standards for quality and acceptable use.

Indemnification by licensee. A provision stating that the licensee is wholly responsible for all products it manufactures or sells or services it provides and must indemnify and hold harmless the Iowa Department of Transportation, its employees and agents for any liability, loss, damage, cost or expense attributable to any of licensee's products bearing the Department's marks.

Term of agreement, termination and renewal option. A provision setting the term of the agreement and stating the Department's right to terminate the agreement or renew it upon expiration. The term of the agreement shall be one year, unless the licensee requests a longer term, which shall be considered.

Notices and other communications. A provision describing where written notices and communications shall be delivered and by what means.

Amendments. A provision on how the licensing agreement may be amended.

Income distribution. Royalty or other income received from licensing will be allocated and distributed according to terms established by the Finance Bureau. Preferential consideration on distribution of revenue shall be given to the field of activity from which the mark was generated and for the administration of the licensing procedures.