

- ① See dowel assemblies for fabrication details.
- ② See Bar Size Table for Contraction Joints on Sheet 2.
- ③ Locate 'DW' joint at a mid-panel location between future 'C' or 'CD' joints. Place no closer than 5 feet to a 'C' or 'CD' joint.
- ④ Place bars within the limits shown under dowel assemblies.
- ⑤ Edge with 1/8 inch tool for length of joint. For HT joint, remove header block and board when second slab is placed.
- ⑥ Unless specified otherwise, use 'CD' transverse contraction joints in mainline pavement when (T) is greater or equal to 8 inches. Use 'C' joints when (T) is less than 8 inches.
- ⑦ 'RT' joint may be used in lieu of 'DW' joint at the end of the days work. Remove any pavement damaged due to the drilling at no additional cost to the Contracting Authority.

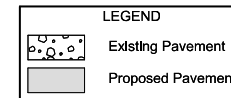

SUDAS	IOWADOT	REVISION
		11 04-19-22
FIGURE 7010.101	STANDARD ROAD PLAN	PV-101
		SHEET 1 of 8

REVISIONS: Modified circle note 32.

Paul D. Weigand
SUDAS DIRECTOR

Shawn Miller
DESIGN METHODS ENGINEER

JOINTS

TRANSVERSE CONTRACTION

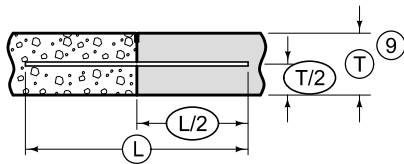

BAR PLACEMENT

(Applies to all joints unless otherwise detailed.)

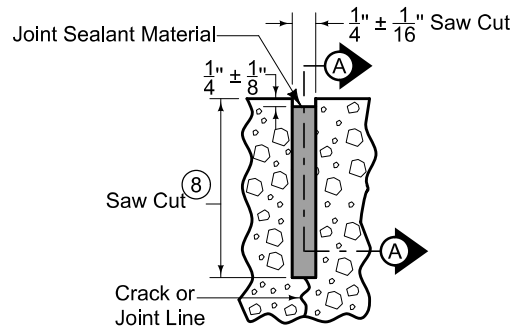

DETAIL A

(Saw cut formed by conventional concrete sawing equipment.)

- ⑧ Saw 'CD' joint to a depth of $T/3 \pm 1/4"$; saw 'C' joint to a depth of $T/4 \pm 1/4"$.
- ⑨ When tying into old pavement, (T) represents the depth of sound PCC.

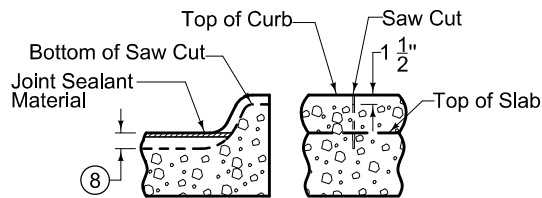

'C' JOINT IN CURB

(Match 'CT', 'CD', or 'C' joint in pavement.)

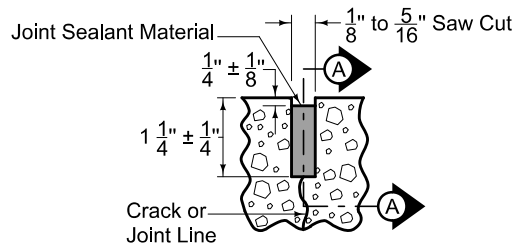

DETAIL B

(Saw cut formed by approved early concrete sawing equipment.)

BAR SIZE TABLE FOR CONTRACTION JOINTS			
(T)	Solid Dowel Diameter	Tubular Dowel Diameter	Tie Bar Size
< 8"	3/4"	7/8"	#6
≥ 8" but < 10"	1 1/4"	1 3/8"	#10
≥ 10"	1 1/2"	1 5/8"	#11

Tubular Dowel Bars will not be allowed for RD joints.

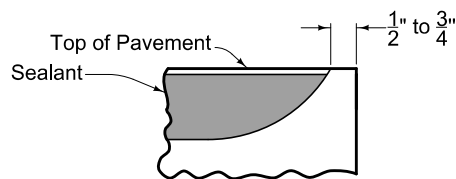

SECTION A-A

(Detail at Edge of Pavement)

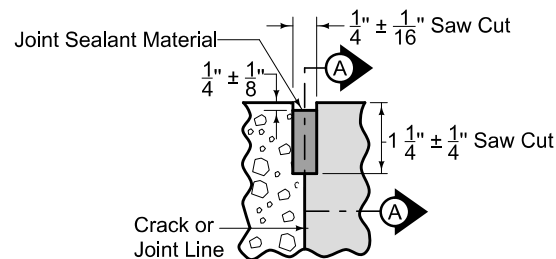

DETAIL C

LEGEND

	Existing Pavement
	Proposed Pavement

		REVISION
		11 04-19-22
FIGURE 7010.101	STANDARD ROAD PLAN	PV-101
		SHEET 2 of 8

REVISIONS: Modified circle note 32.

Paul D. Wigand
SUDAS DIRECTOR

Stuart Miller
DESIGN METHODS ENGINEER

JOINTS

TRANSVERSE CONTRACTION

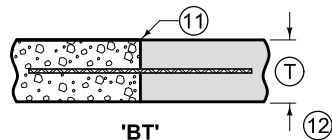
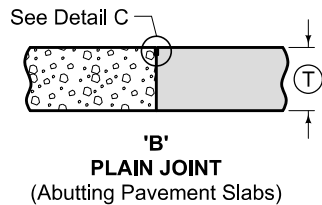

ABUTTING PAVEMENT JOINT - RIGID TIE

Ⓣ	Joint	Bars	Bar Length and Spacing
< 8"	'BT-1'	#4	36" Long at 30" Centers
		#5	30" Long at 30" Centers
≥ 8"	'BT-2'	#5	36" Long at 30" Centers

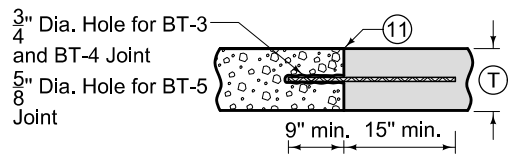

ABUTTING PAVEMENT JOINT - RIGID TIE (Drilled)

Ⓣ	Joint	Bars	Bar Length and Spacing
< 8"	'BT-5'	#4	24" Long at 30" Centers
≥ 8"	'BT-3'	#5	24" Long at 30" Centers
	'BT-4'		24" Long at 15" Centers

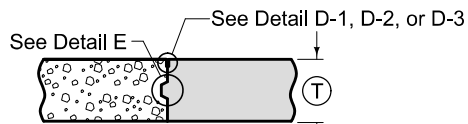

KEYED JOINT FOR ADJACENT SLABS
(Where T is 8" or more)

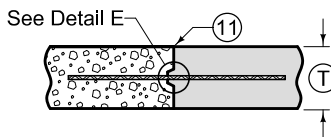
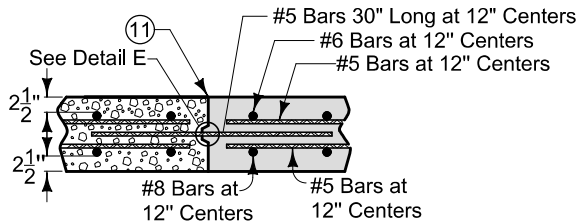
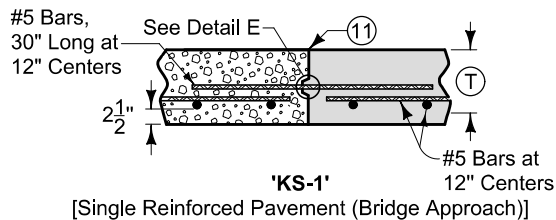

ABUTTING PAVEMENT JOINT - KEYWAY TIE

Ⓣ	Joint	Bars	Bar Length and Spacing
< 8"	'KT-1'	#4	30" Long at 30" Centers
≥ 8"	'KT-2'	#5	30" Long at 30" Centers
	'KT-3'		30" Long at 15" Centers

LONGITUDINAL CONTRACTION

- Ⓣ Bar supports may be necessary for fixed form paving to ensure the bar remains in a horizontal position in the plastic concrete.
- Ⓣ Sawing or sealing of joint not required.
- Ⓣ The following joints are interchangeable, subject to the pouring sequence:
'BT-1', 'L-1', and 'KT-1'
'KT-2' and 'L-2'
'KT-3' and 'L-3'

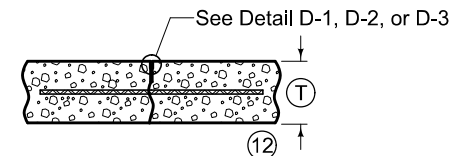

Ⓣ	Joint	Bars	Bar Length and Spacing
< 8"	'L-1'	#4	36" Long at 30" Centers
≥ 8"	'L-2'	#5	36" Long at 30" Centers
	'L-3'		36" Long at 15" Centers

FIGURE 7010.101 SHEET 3 OF 8

LEGEND

Existing Pavement

Proposed Pavement

SUDAS IOWADOT FIGURE 7010.101 STANDARD ROAD PLAN	REVISION 11 04-19-22
	PV-101 SHEET 3 of 8

REVISIONS: Modified circle note 32.

Paul D. Wigand
 SUDAS DIRECTOR

Stuart Miller
 DESIGN METHODS ENGINEER

JOINTS

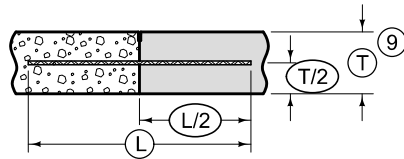

TIE BAR PLACEMENT
(Applies to all joints unless otherwise detailed.)

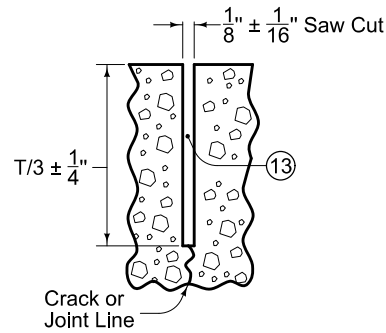

DETAIL D-1
(Required when specified in the contract documents.)

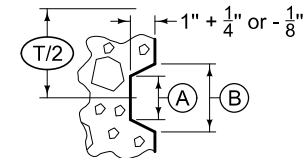

DETAIL E

- ⑨ When tying into old pavement, (T) represents the depth of sound PCC.
- ⑬ Sealant or cleaning not required.

KEYWAY DIMENSIONS

Keyway Type	Pavement Thickness (T)	(A)	(B)
Standard	8" or greater	1 3/4"	2 3/4"
Narrow	Less than 8"	1"	2"

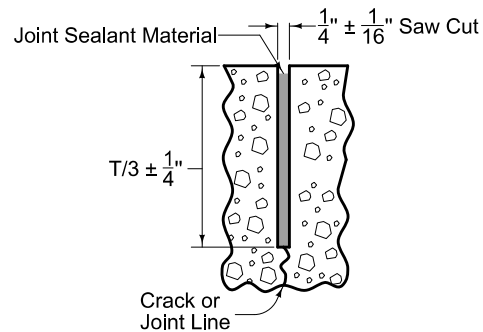

DETAIL D-2
(Required when the Department of Transportation is not the Contracting Authority, or when specified in the contract documents)

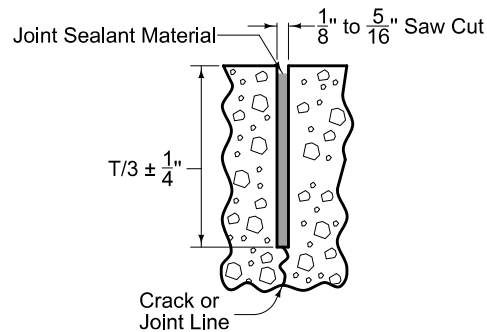

DETAIL D-3
(Required when the Department of Transportation is the Contracting Authority, or when specified in the contract documents)

LEGEND

	Existing Pavement
	Proposed Pavement

		REVISION
		11 04-19-22
FIGURE 7010.101	STANDARD ROAD PLAN	PV-101
		SHEET 4 of 8

REVISIONS: Modified circle note 32.

Paul D. Wigand
SUDAS DIRECTOR

Stuart Miller
DESIGN METHODS ENGINEER

LONGITUDINAL CONTRACTION

JOINTS

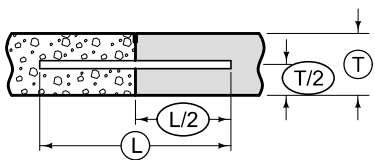

DOWEL PLACEMENT

(Applies to all joints unless otherwise detailed.)

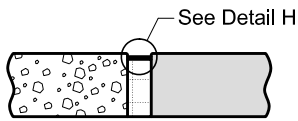

Width (See table below)
'CF' JOINT

TYPE	WIDTH
CF-1	2"
CF-2	2 1/2"
CF-3	3"
CF-4	3 1/2"

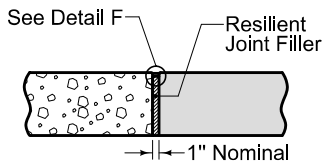

'E' JOINT
1" EXPANSION JOINT

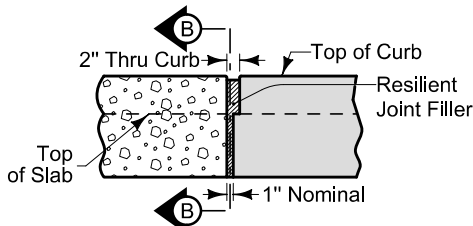

'E' JOINT IN CURB
(View at Back of Curb)

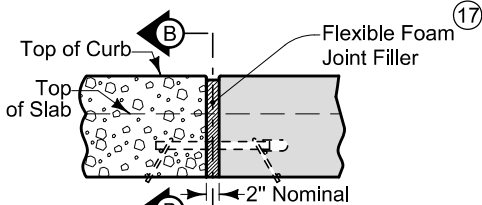

'EE' JOINT IN CURB
(View at Back of Curb)

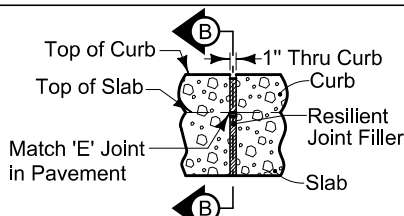

'ES' JOINT IN CURB
(View at Back of Curb)

Detail F or Detail G (See Bar Size Table for Doweled Expansion Joints)
Joint Filler Material (17) (See Bar Size Table for Doweled Expansion Joints)

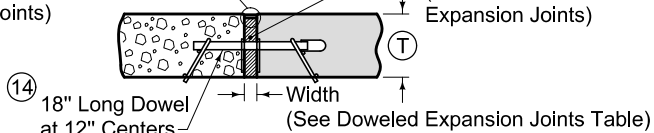

'ED', 'EE', 'EF' (16) DOWELED EXPANSION JOINT

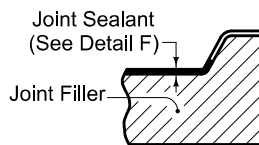

SECTION B-B

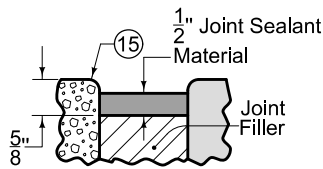

DETAIL F

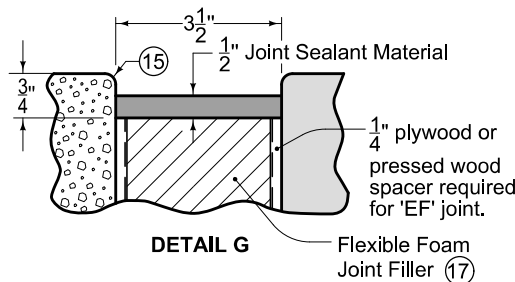

DETAIL G

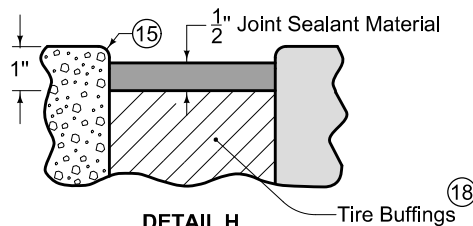

DETAIL H

EXPANSION

- (14) See Bar Size Table for Doweled Expansion Joints.
- (15) Edge with 1/4 inch tool for length of joint indicated if formed; edging not required when cut with diamond blade saw.
- (16) See Dowel Assemblies for fabrication details and placement limits. Coat the free end of dowel bar to prevent bond with pavement. At intake locations, dowel bars may be cast-in-place.
- (17) Predrill or preform holes in joint material for appropriate dowel size.
- (18) Compact tire buffings by spading with a square-nose shovel.

DOWELED EXPANSION JOINTS

TYPE	WIDTH	FILLER MATERIAL (17)
ED	1"	Resilient (Detail F)
EE	2"	Flexible Foam (Detail F)
EF	3 1/2"	Flexible Foam (Detail G)

BAR SIZE TABLE FOR DOWELED EXPANSION JOINTS

(T)	< 8"	≥ 8" but < 10"	≥ 10"
Dowel Diameter	3/4	1 1/4	1 1/2

Tubular Dowel Bars will not be allowed for expansion joints.

LEGEND

	Existing Pavement
	Proposed Pavement

		REVISION
		11 04-19-22
FIGURE 7010.101	STANDARD ROAD PLAN	PV-101
		SHEET 5 of 8

REVISIONS: Modified circle note 32.

Paul D. Weigand
SUDAS DIRECTOR

Shawn Miller
DESIGN METHODS ENGINEER

JOINTS

CONTRACTION JOINTS

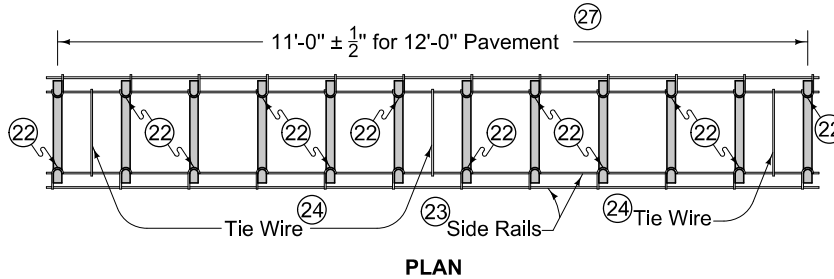

Spaces between dowel bars are nominal dimensions with a $\frac{1}{4}$ " allowable tolerance.

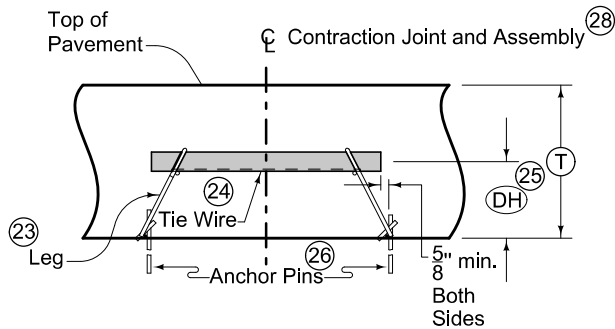
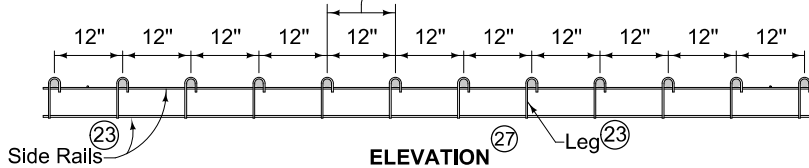

LONGITUDINAL SECTION

DOWEL ASSEMBLIES (19)(20)(21)

- (19) Use 18 inch long dowel bars with a tolerance of $\pm 1/8$ inch. Ensure the centerlines of individual dowels are parallel to the other dowels in the assembly within $\pm 1/8$ inch.
- (20) Use wires with a minimum tensile strength of 50 ksi.
- (21) Details apply to both transverse contraction and expansion joints.
- (22) Weld alternately throughout.
- (23) 0.306 inch diameter wire. Wire sizes shown are the minimum required.
- (24) Maximum 0.177 inch diameter wire, welded or friction fit to upper side rail, both sides.
- (25) Measured from the centerline of dowel bar to bottom of lower side rail + 1/4 inch.
- (26) Per lane width, install a minimum of 8 anchor pins evenly spaced (4 per side), to prevent movement of assembly during construction. Anchor assemblies placed on pavement or PCC base with devices approved by the Engineer.
- (27) If dowel basket assemblies are required for curbed pavements, the assembly length is based on the jointing layout. See PV-101, sheet 8.
- (28) Ensure dowel basket assembly centerline is within 2 inches of the intended joint location longitudinally and has no more than 1/4 inch horizontal skew from end of basket to end of basket.

DOWEL HEIGHT AND DIAMETER FOR DOWELED CONTRACTION JOINTS

(T)	(DH) (25)	Diameter (Solid)	Diameter (Tubular)
7" to 7 $\frac{1}{2}$ "	3 $\frac{1}{2}$ "	$\frac{3}{4}$ "	$\frac{7}{8}$ "
8" to 9 $\frac{1}{2}$ "	4 $\frac{1}{4}$ "	1 $\frac{1}{4}$ "	1 $\frac{3}{8}$ "
10" to 11 $\frac{1}{2}$ "	5 $\frac{1}{4}$ "	1 $\frac{1}{2}$ "	1 $\frac{5}{8}$ "
12" to 13"	6 $\frac{1}{4}$ "	1 $\frac{1}{2}$ "	1 $\frac{5}{8}$ "

Tubular Dowel Bars will not be allowed for RD joints.

SUDAS	IOWADOT	REVISION
		11 04-19-22
FIGURE 7010.101	STANDARD ROAD PLAN	PV-101
		SHEET 6 of 8

REVISIONS: Modified circle note 32.

Paul D. Wigand
 SUDAS DIRECTOR

Stuart Miller
 DESIGN METHODS ENGINEER

EXPANSION JOINTS

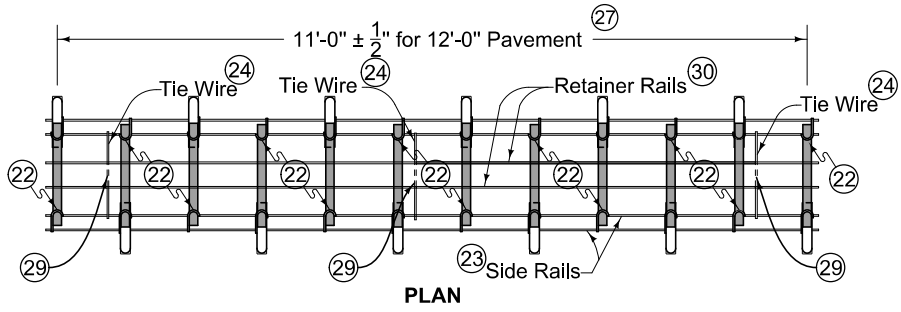

PLAN

Spaces between dowel bars are nominal dimensions with a 1/4" allowable tolerance.

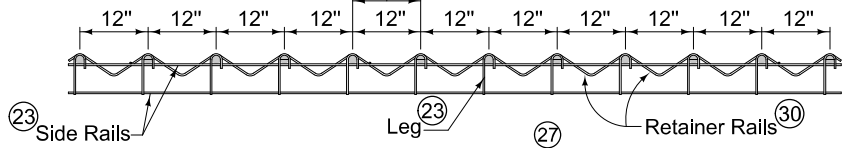

ELEVATION

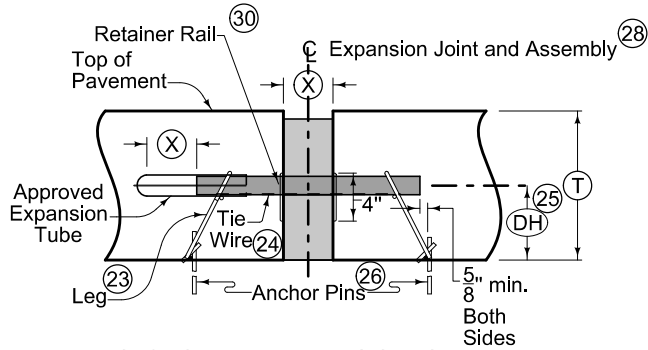

SECTION THRU EXPANSION JOINT

DOWEL HEIGHT AND DIAMETER FOR DOWELED EXPANSION JOINTS

(T)	(DH) (25)	Diameter
7" to 7 1/2"	3 1/2"	3/4"
8" to 9 1/2"	4 1/4"	1 1/4"
10" to 11 1/2"	5 1/4"	1 1/2"
12" to 13"	6 1/4"	1 1/2"

Tubular Dowel Bars will not be allowed for expansion joints.

JOINT OPENING AND EXPANSION TUBE EXTENSION		
Joint Type	(X)	Minimum Tube Length
"ED"	1"	6"
"EE"	2"	7"
"EF"	3 1/2"	9"

DOWEL ASSEMBLIES

(19) (20) (21)

- (19) Use 18 inch long dowel bars with a tolerance of ± 1/8 inch. Ensure the centerlines of individual dowels are parallel to the other dowels in the assembly within ± 1/8 inch.
- (20) Use wires with a minimum tensile strength of 50 ksi.
- (21) Details apply to both transverse contraction and expansion joints.
- (22) Weld alternately throughout.
- (23) 0.306 inch diameter wire. Wire sizes shown are the minimum required.
- (24) Maximum 0.177 inch diameter wire, welded or friction fit to upper side rail, both sides.
- (25) Measured from the centerline of dowel bar to bottom of lower side rail + 1/4 inch.
- (26) Per lane width, install a minimum of 8 anchor pins evenly spaced (4 per side), to prevent movement of assembly during construction. Anchor assemblies placed on pavement or PCC base with devices approved by the Engineer.
- (27) If dowel basket assemblies are required for curbed pavements, the assembly length is based on the jointing layout. See PV-101, sheet 8.
- (28) Ensure dowel basket assembly centerline is within 2 inches of the intended joint location longitudinally and has no more than 1/4 inch horizontal skew from end of basket to end of basket.
- (29) Clip and remove center portion of tie during field assembly.
- (30) 1/4 inch diameter wire.

FIGURE 7010.101 SHEET 7 OF 8

SUDAS	IOWADOT	REVISION	
		11	04-19-22
FIGURE 7010.101 STANDARD ROAD PLAN		PV-101	
		SHEET 7 of 8	
REVISIONS: Modified circle note 32.			
Paul D. Weigand SUDAS DIRECTOR		[Signature] DESIGN METHODS ENGINEER	
JOINTS			

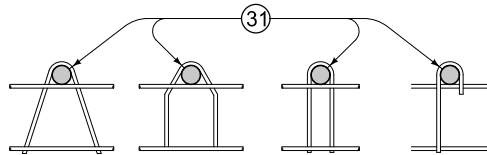

OPTIONAL LEG SHAPES

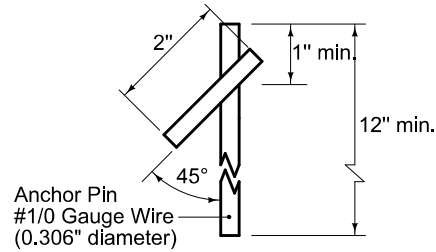

ANCHOR PIN

- ⑲ Use 18 inch long dowel bars with a tolerance of $\pm 1/8$ inch. Ensure the centerlines of individual dowels are parallel to the other dowels in the assembly within $\pm 1/8$ inch.
- ⑳ Use wires with a minimum tensile strength of 50 ksi.
- ㉑ Details apply to both transverse contraction and expansion joints.
- ㉓ Diameter of bend around dowel is dowel diameter + $1/8$ to $3/16$ inches.
- ㉔ For uniform lane widths: 3 to 6 inches. For taper and variable width pavements: 3 to 12 inches.

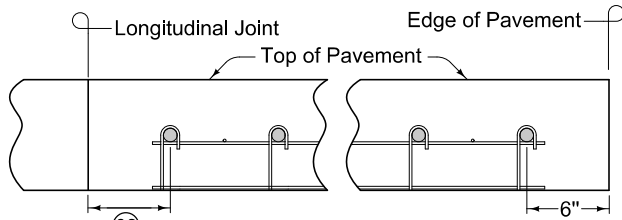

PLACEMENT LIMITS
(Rural Section)

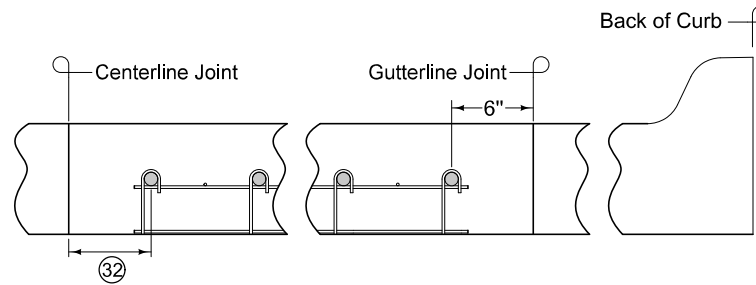

PLACEMENT LIMITS
(Curb and Gutter - Gutterline Jointing)

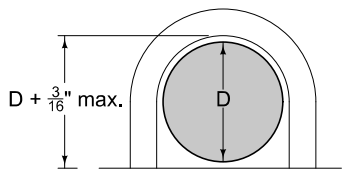

BEND AROUND DOWEL ㉓

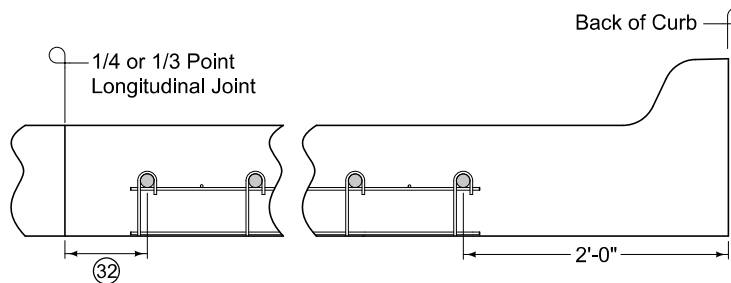

PLACEMENT LIMITS
(Curb and Gutter - 1/4 or 1/3 Point Jointing)

DOWEL ASSEMBLIES ⑲ ⑳ ㉑

FIGURE 7010.101 SHEET 8 OF 8

		REVISION
		11 04-19-22
FIGURE 7010.101	STANDARD ROAD PLAN	PV-101
		SHEET 8 of 8
REVISIONS: Modified circle note 32.		
 SUDAS DIRECTOR		 DESIGN METHODS ENGINEER
JOINTS		