

END POST

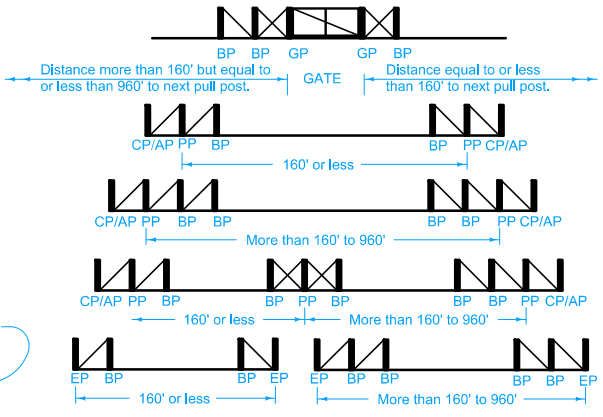

BRACE PANEL LAYOUT

PP = Pull Post CP = Corner Post AP = Angle Post
 BP = Brace Post EP = End Post GP = Gate Post

Double wrap barbed wire and tie off at end posts, corner posts, and line brace posts. Single wrap woven wire and tie off. Restart fence to be continued, in like manner.

Fence wire fabric may be placed on either the road side or the field side of posts, depending on local conditions; i.e., on curves, the wire should be placed on the side which would result in the least amount of tension on the staples. This will also apply where wind, drift, or other conditions would exert unusual pressure against the wire.

Refer to MI-104 for fencing at Channel Crossings, Minor Groud Depressions, and Flood Plains.

- ① Brace Panel.
- ② Brace Wire: 4 strands of No. 9 wire.
- ③ Details indicate placement of granular material for certain posts. The Contractor has the option to drive posts if method demonstrated is satisfactory to the Engineer. Granular material will not be required for driven posts.
- ④ Metal brace 8 feet long.
- ⑤ Wrap wire fabric around post.
- ⑥ Pull Post Assembly is required when the distance between pull posts is greater than 960 feet in straight lines of fence.

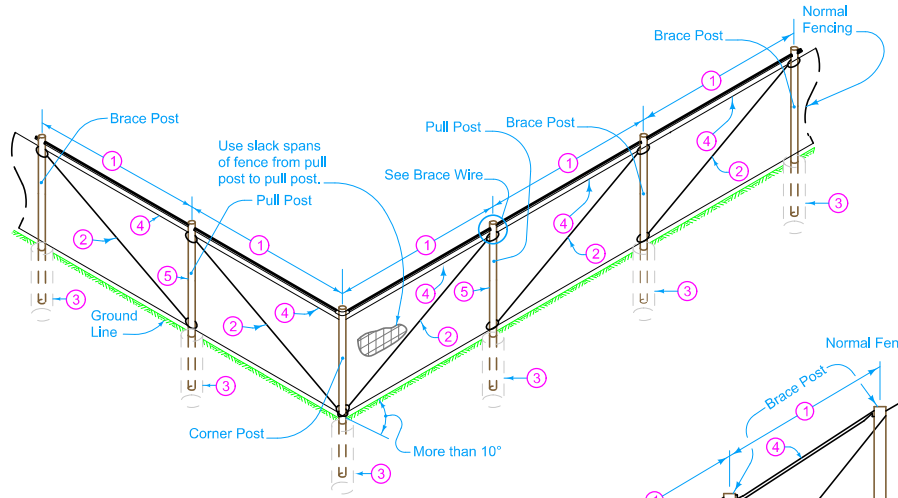

CORNER POST

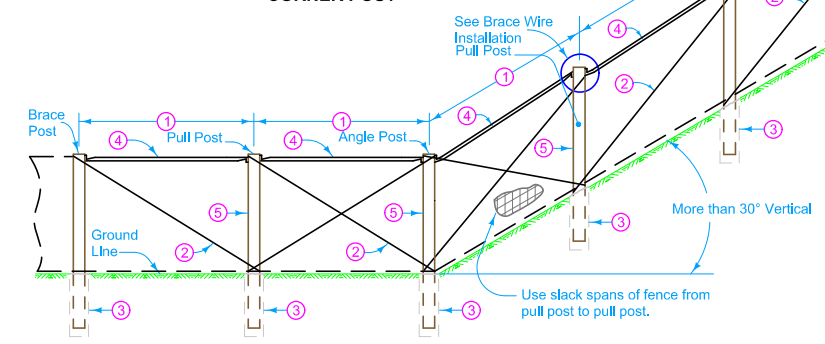

ANGLE POST

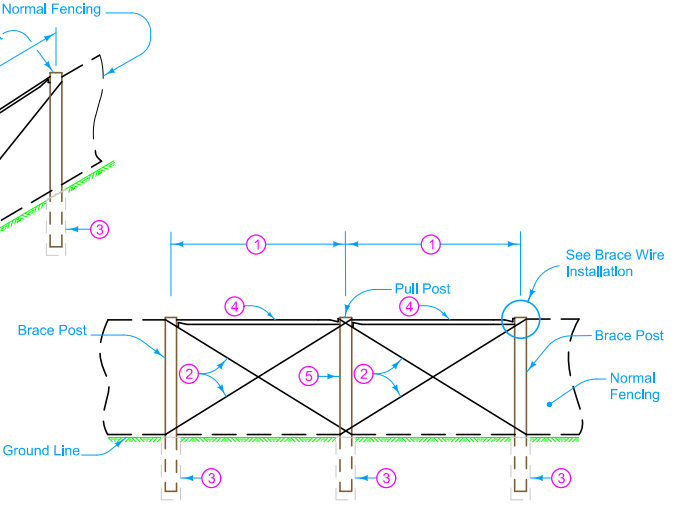

PULL POST

Possible Contract Items:
 Deer Fence
 Deer Fence Brace Panels
 Deer Fence Gate
 Field Fence
 Field Fence Brace Panel
 Field Fence Gate

Possible Tabulation:
 100-7

IOWA DOT	REVISION
	2 10-20-15
STANDARD ROAD PLAN	MI-103
SHEET 1 of 7	
REVISIONS: Added Designer Info button.	
APPROVED BY DESIGN METHODS ENGINEER	
DEER FENCE AND FIELD FENCE CONSTRUCTION	

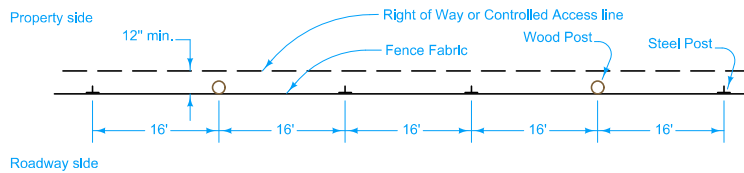

PLAN

FIELD FENCE

DEER FENCE

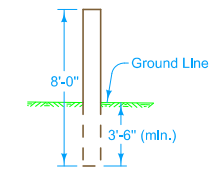

ANGLE, BRACE, CORNER, END OR PULL POST (WOOD)

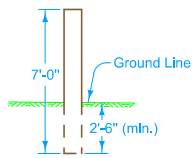

LINE POST (WOOD)

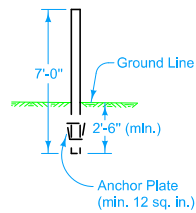

LINE POST (STEEL)

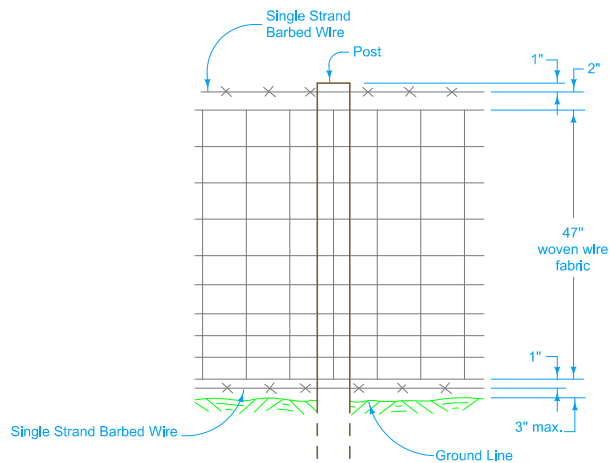

ELEVATION

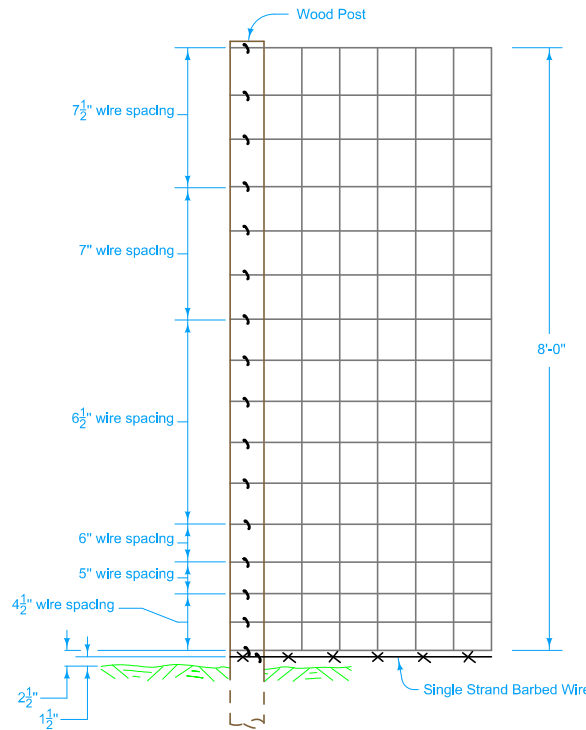

ELEVATION

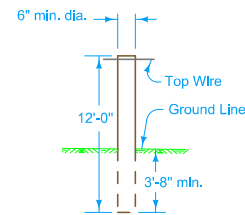

WOOD POST

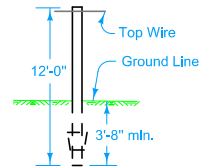

STEEL POST

 STANDARD ROAD PLAN	REVISION
	2 10-20-15
	MI-103
SHEET 2 of 7	

REVISIONS: Added Designer Info button.
Brian Smith
 APPROVED BY DESIGN METHODS ENGINEER

DEER FENCE AND FIELD FENCE CONSTRUCTION

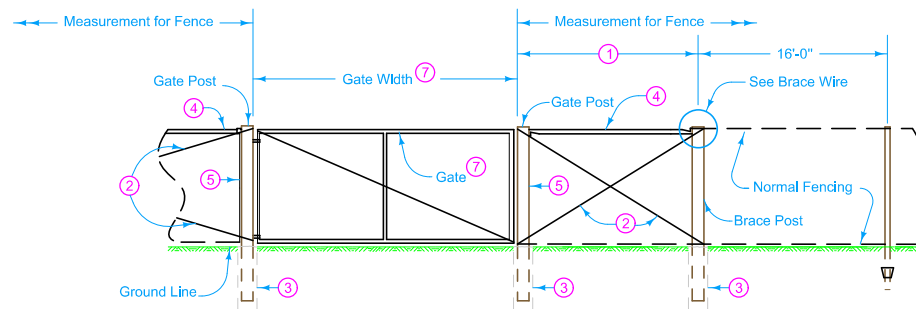

FIELD FENCE GATE

- ① Brace Panel.
- ② Brace Wire: 4 strands of No. 9 wire.
- ③ Details indicate placement of granular material for certain posts. The Contractor has the option to drive posts if method demonstrated is satisfactory to the Engineer. Granular material will not be required for driven posts.
- ④ Metal brace 8 feet long.
- ⑤ Wrap wire fabric around post.
- ⑦ Unless specified otherwise, install a 16 foot gate. Double gate is required only for widths more than 16 feet. Exact details of gate design are subject to the approval of the Engineer. Install as recommended by the manufacturer.

IOWA DOT	REVISION	
	2	10-20-15
STANDARD ROAD PLAN		MI-103
		SHEET 3 of 7
REVISIONS: Added Designer Info button.		
<i>Brian Smith</i>		
APPROVED BY DESIGN METHODS ENGINEER		
DEER FENCE AND FIELD FENCE CONSTRUCTION		

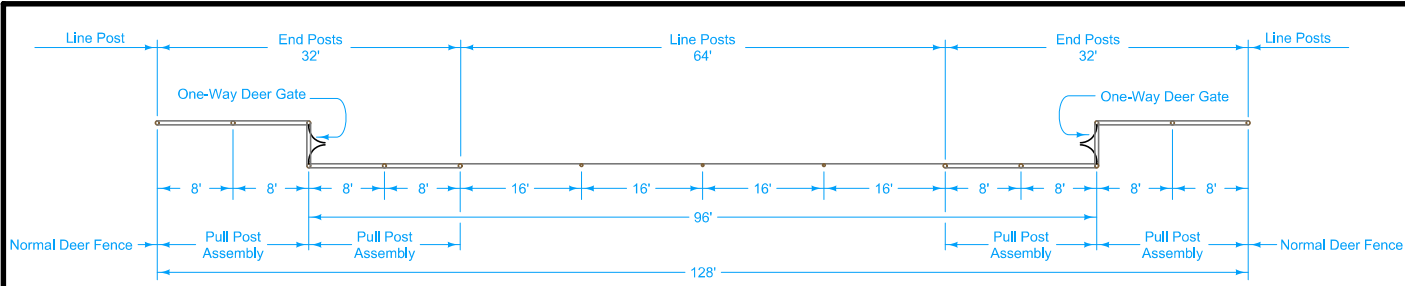

PLAN

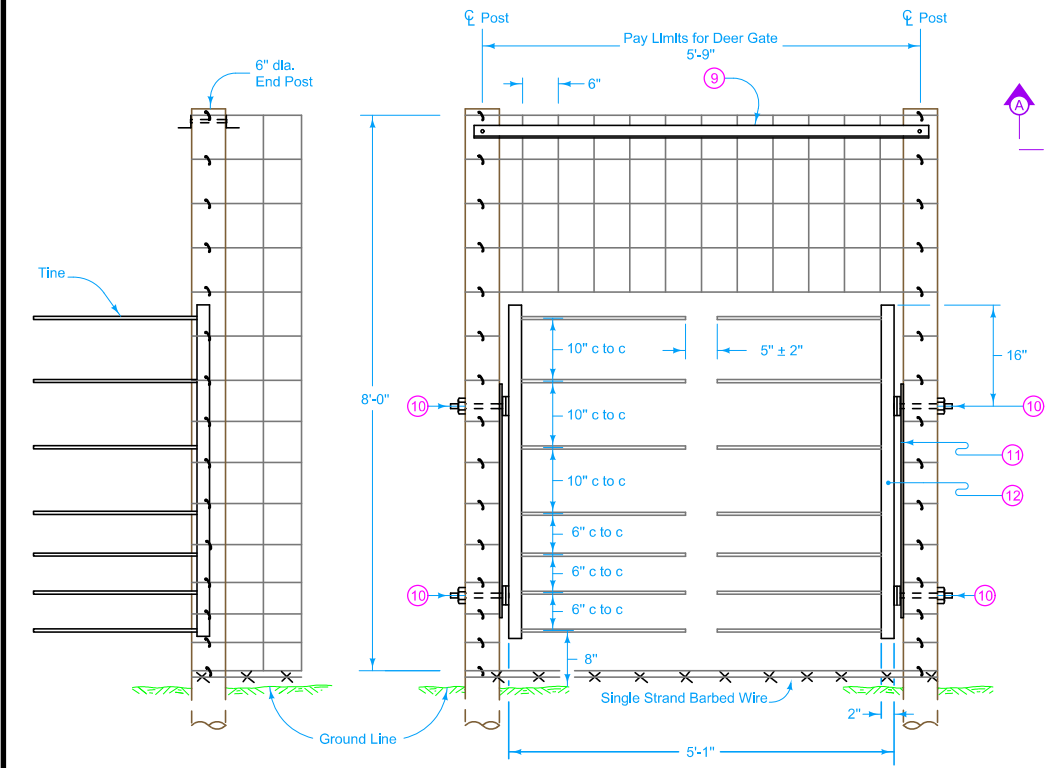

SECTION A-A

PROFILE

DEER GATE

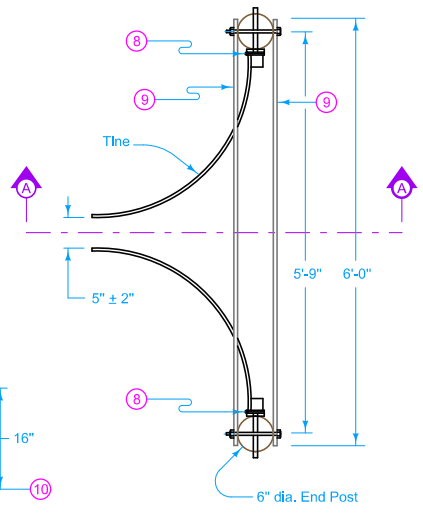

DEER GATE TOP

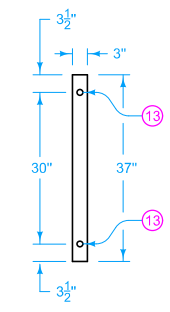

SUPPORT PLATE

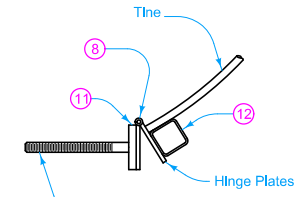

HINGE

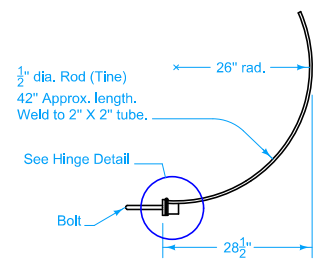

TINE

- 8 Spring loaded hinge allows tines to spread apart and return to original position.
- 9 Two 2 in. x 2 in. x $\frac{1}{8}$ in. L top braces held by $\frac{1}{2}$ inch diameter bolts.
- 10 Attach nut and washer to each bolt.
- 11 Support Plate 3 in. x $\frac{5}{16}$ in. x 37 in.
- 12 2 in. x 2 in. x 54 in. structural steel tubing welded to Hinge Plate.
- 13 $\frac{3}{4}$ in. diameter x 8 in. bolt welded to Support Plate

 STANDARD ROAD PLAN	REVISION 2 10-20-15
	MI-103 SHEET 4 of 7
	REVISIONS: Added Designer Info button.
<i>Brian Smith</i> APPROVED BY DESIGN METHODS ENGINEER	
DEER FENCE AND FIELD FENCE CONSTRUCTION	

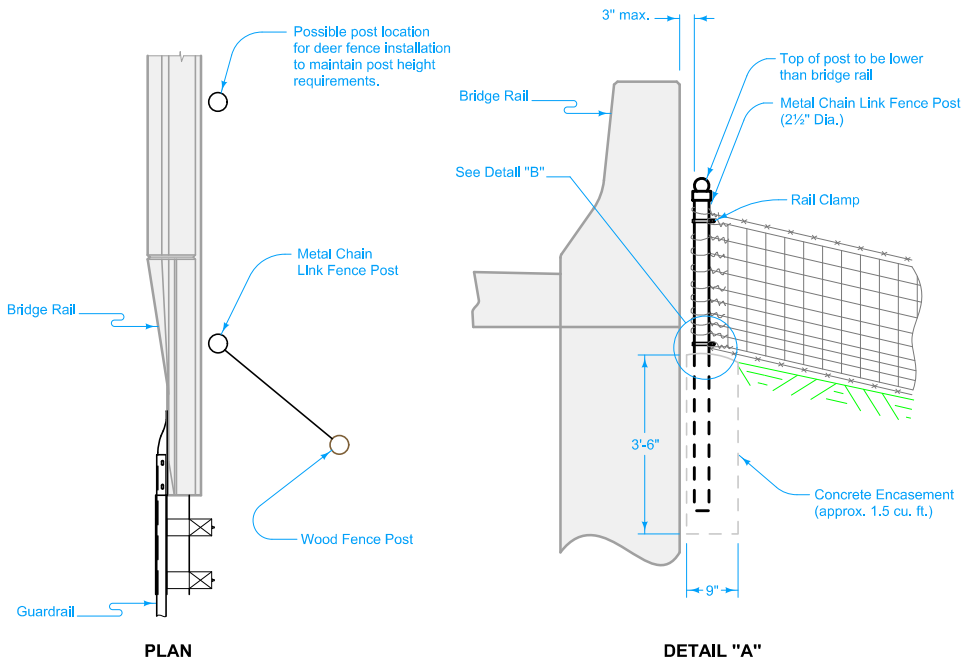
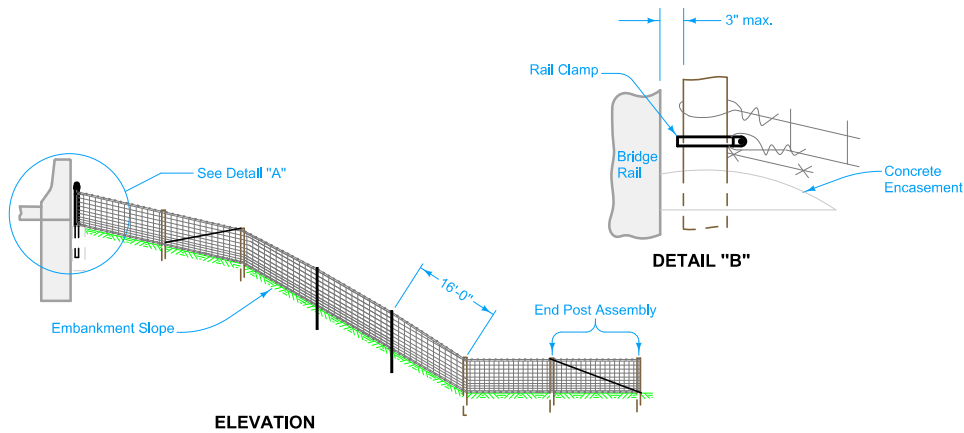

FENCE TERMINATION AT BRIDGES ¹⁴

- ¹⁴ Fence termination at bridges, culverts, and other structures as detailed hereon will not be paid for separately but will be considered incidental to the bid item "Deer Fence" or "Field Fence."
- ¹⁵ Place minimum of four (4) barbed wires fan shaped, connected to eye bolt on culvert wall or set 4 inch post when necessary.

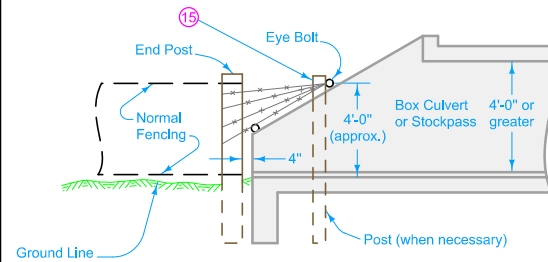
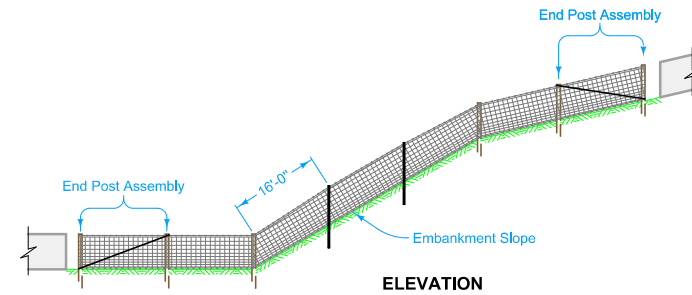

BOX CULVERTS OR STOCK PASSES 4 FEET OR LARGER

FENCE TERMINATION AT STRUCTURES ¹⁵

IOWA DOT	REVISION	
	2	10-20-15
STANDARD ROAD PLAN		MI-103
		SHEET 5 of 7
REVISIONS: Added Designer Info button.		
<i>Brian Smith</i>		
APPROVED BY DESIGN METHODS ENGINEER		
DEER FENCE AND FIELD FENCE CONSTRUCTION		

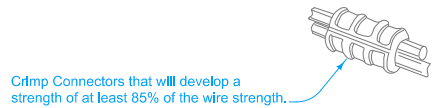

Crimp Connectors that will develop a strength of at least 85% of the wire strength.

CRIMP CONNECTION



Make a minimum of four tight wraps on the connecting wire. Ends of the wrap to be trimmed flush.

IN-LINE CONNECTION

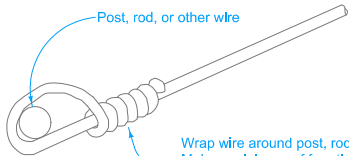

Post, rod, or other wire

Wrap wire around post, rod or other wire. Make a minimum of four tight wraps back around itself. Ends of the wrap to be trimmed flush.

SELF-WRAP CONNECTION

APPROVED WIRE CONNECTIONS

1/2" Galvanized Rod
(Fabric height plus 2" min. length)

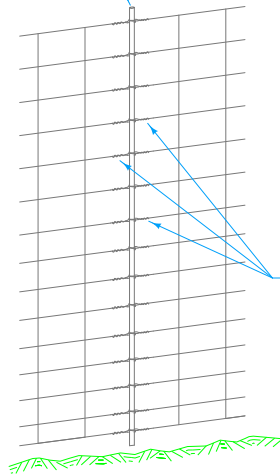

SPLICE WITH ROD

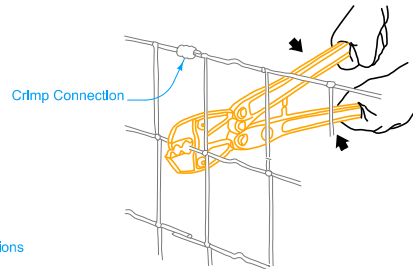

CRIMP SPLICE

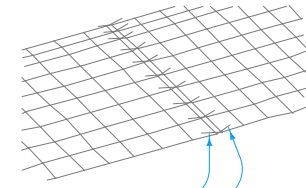

End of Stay Wires

FABRIC SPLICES

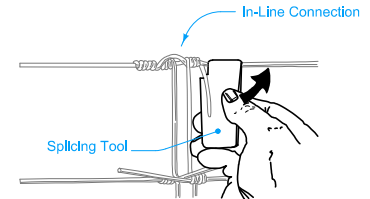

OVERLAP SPLICE

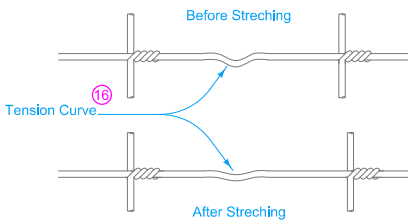

Before Stretching

Tension Curve

After Stretching

STRETCHING DETAILS

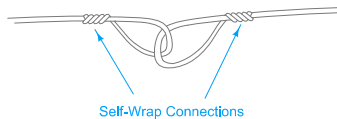

Self-Wrap Connections

BRACE WIRE SPLICE

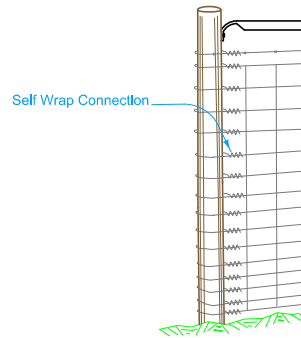

Self Wrap Connection

END POST CONNECTION

- 16 Tension curve consists of a "U" shaped crimp in the fence wires and has the same effect as a spring. Stretch to 50% removal of the factory crimp.
- 17 Crimp connection and in-line connection are also acceptable brace wire splices.

FENCE ASSEMBLY

	REVISION
	2 10-20-15
STANDARD ROAD PLAN	MI-103
REVISIONS: Added Designer Info button.	SHEET 6 of 7
APPROVED BY DESIGN METHODS ENGINEER	
DEER FENCE AND FIELD FENCE CONSTRUCTION	

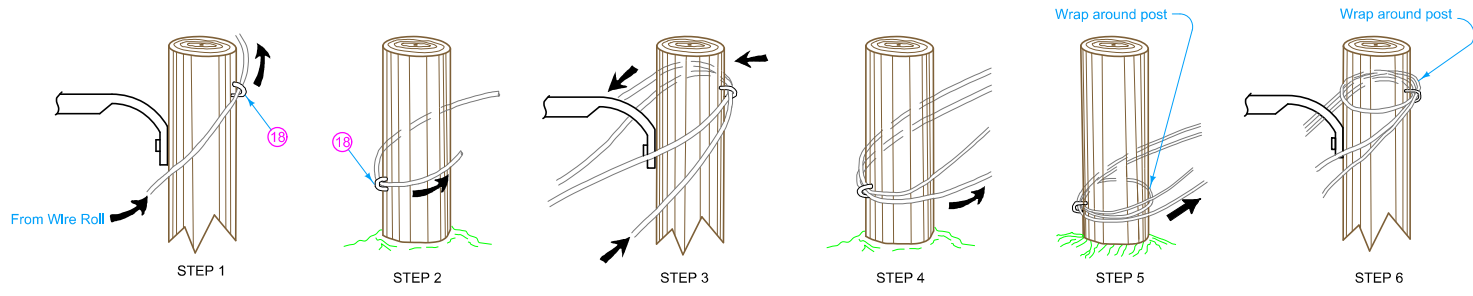

- ② Brace Wire: 4 strands of No. 9 wire.
- ④ Metal brace 8 feet long.
- ⑱ Set staples cross-wise to the grain. Drive staples tight at pull posts. Drive all other staples firm, but loose enough to allow lateral movement of the wire.
- ⑲ Twist the two brace wires together to produce proper tension in the brace assembly.

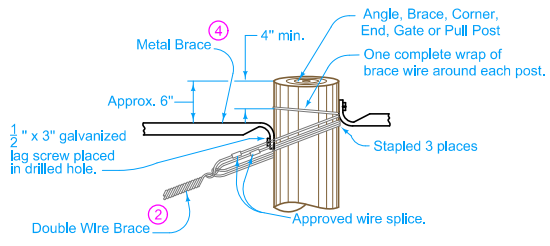

BRACE WIRE INSTALLATION ⑲
 (Brace wire wrapped the same at the bottom of post.)

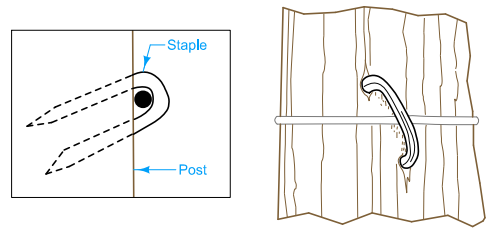

STAPLES ⑱

WIRE ASSEMBLY

IOWA DOT	REVISION	
	2	10-20-15
STANDARD ROAD PLAN		MI-103
		SHEET 7 of 7
REVISIONS: Added Designer Info button.		
 <small>APPROVED BY DESIGN METHODS ENGINEER</small>		
DEER FENCE AND FIELD FENCE CONSTRUCTION		