

Layouts shown are for typical installations. Drawings are oriented to represent direction of traffic moving from left to right.

Center markings within the lane.

All dimensions shown are nominal. For proper proportion details, see current MUTCD Standard Highway Signs and Markings booklet.

Pavement word, symbol, and arrow markings are to be proportionally scaled to fit within the width of the facility upon which they are applied.

Except for the SCHOOL word marking, all markings are to be no more than one lane in width.

① Add template for Right Turn Arrow (RTAW) to Left Turn Arrow (LTAW) or Combined Straight and Left Turn Arrow (CSLW) to create new templates.

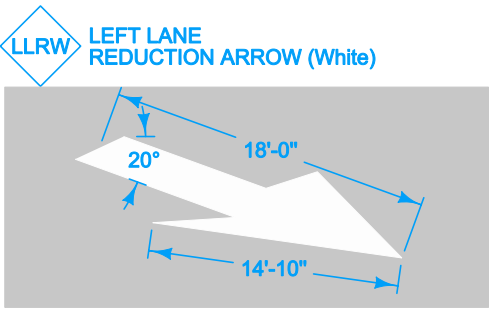
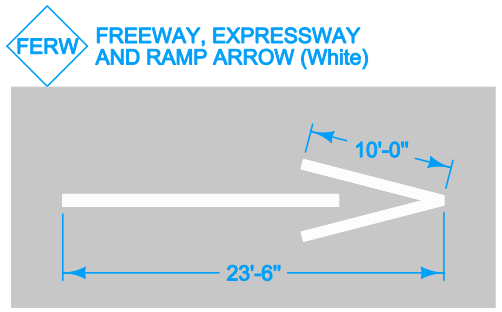
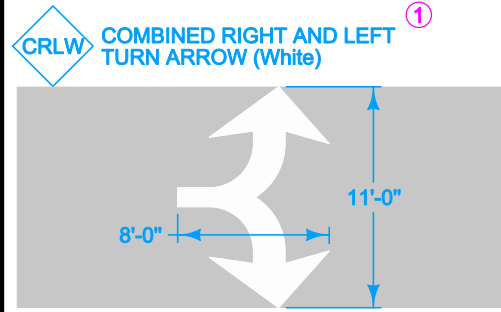
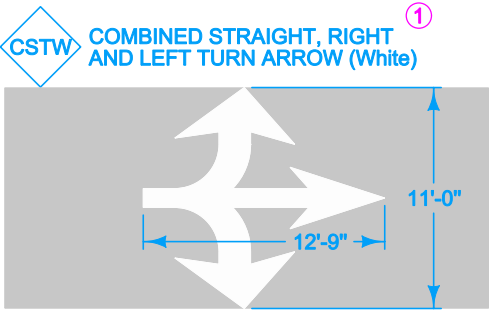
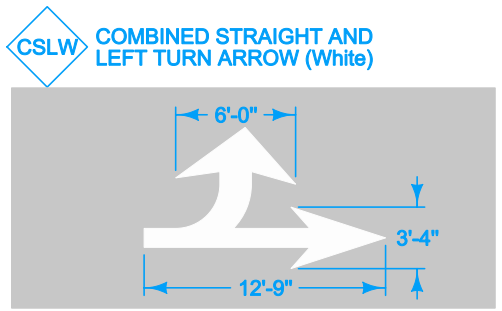
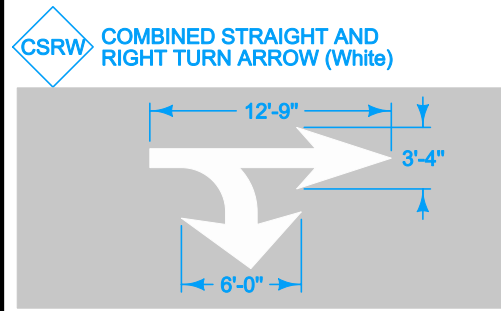

Possible Contract Item:
Pavement Marking Symbol and Legend Items

Possible Tabulation:
108-29

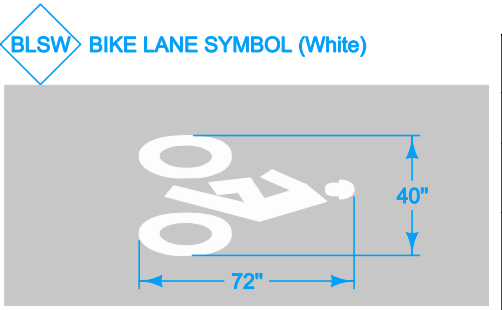
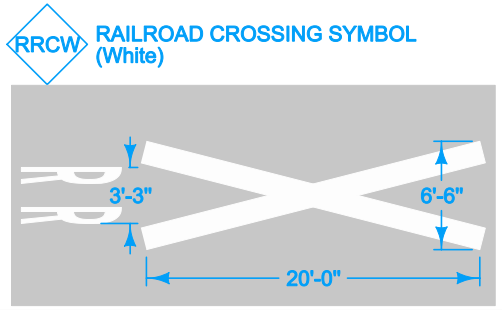
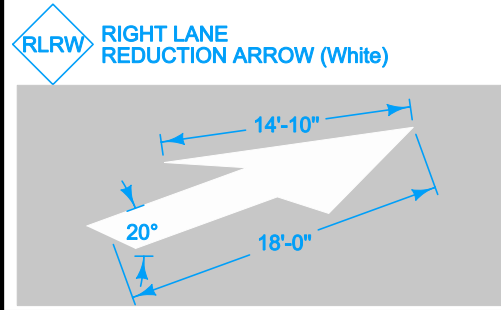

<p>Iowa Department of Transportation</p>	REVISION
	New 04-19-11
STANDARD ROAD PLAN	PM-111
REVISIONS: New. Replaces Details 9002 thru 9016.	SHEET 1 of 2
<p><i>Deanna McFife</i> APPROVED BY DESIGN METHODS ENGINEER</p>	
<p>SYMBOLS AND LEGENDS</p>	

WCSW WHEELCHAIR SYMBOL (White)

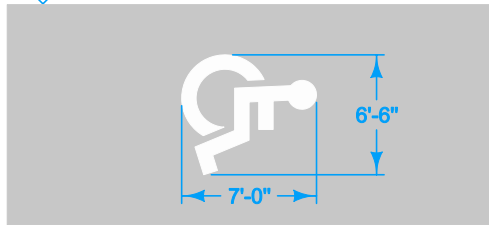

WPSB WHEELCHAIR PARKING SYMBOL (Blue)

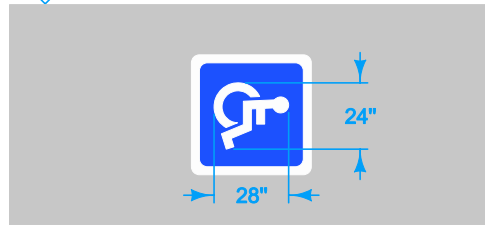

② When placed across one lane, use the smaller dimensions shown. When placed across two lanes, use the larger dimensions shown.

SCLW SCHOOL WORD MARKING (White) ②

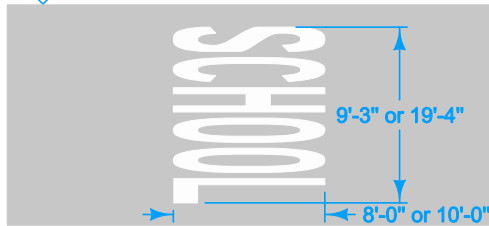

XNGW XING WORD MARKING (White)

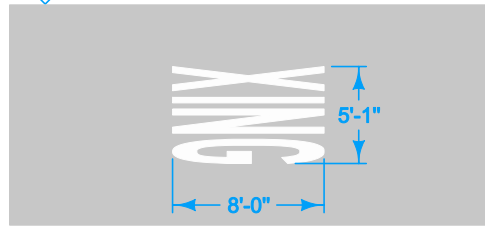

STPW STOP WORD MARKING (White)

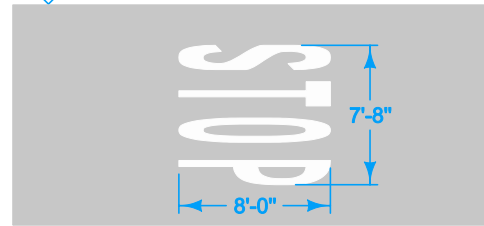

AHDW AHEAD WORD MARKING (White)

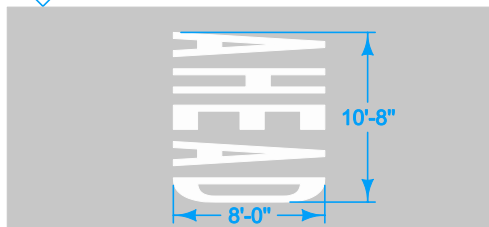

ONLW ONLY WORD MARKING (White)

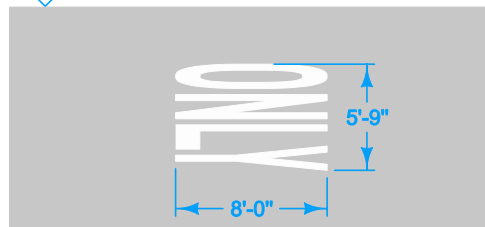

BIKW BIKE WORD MARKING (White)

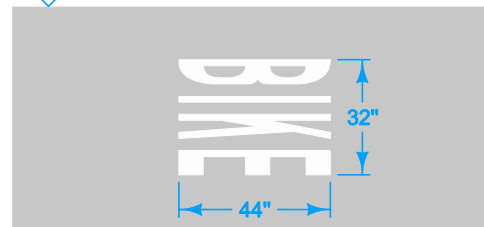

LANW LANE WORD MARKING (White)

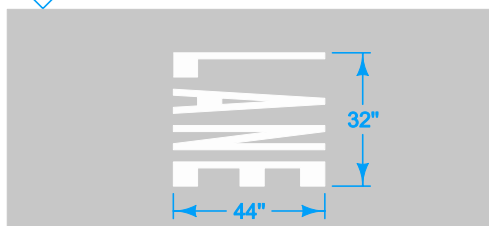

 Iowa Department of Transportation	REVISION
	New 04-19-11
STANDARD ROAD PLAN	PM-111
REVISIONS: New. Replaces Details 9002 thru 9016.	SHEET 2 of 2
<i>Deanna McFalls</i> APPROVED BY DESIGN METHODS ENGINEER	
SYMBOLS AND LEGENDS	